

# Rialta

## TO THE OWNER

---

Congratulations! We welcome you to the exciting world of motor home travel and camping. You will find it convenient and enjoyable to have all the comforts of home and still enjoy the great outdoors wherever you choose to go.

Your new Rialta motor home has been carefully designed, engineered and manufactured to provide dependability as well as safety. Before sliding into the driver's seat, take a few minutes to become familiar with operations and features. This manual was prepared to aid you in the proper care and operation of the vehicle and equipment. We urge you to read it completely. In addition, spend some time with the dealer when you take delivery, you will want to learn all you can about your new motor home.

Your new Rialta is covered by a factory warranty against defects in material and workmanship. This warranty should be validated at once and returned to the factory by your dealer.

Read and understand all instructions and precautions in this manual before operating your new motor home. Throughout this manual, certain items are labeled NOTE, CAUTION and WARNING. These terms alert you to precautions that can involve risk to your vehicle or to your personal safety. Read and follow them carefully.

*NOTE: Indicates a special point of information.*

### **CAUTION**

Indicates that a failure to observe can cause damage to vehicle or equipment

### **WARNING**

This symbol is used to alert you to precautions that involve your personal safety as well as vehicle damage. Read and follow them carefully.

OWNER'S NAME
STREET ADDRESS
CITY AND STATE (OR PROVINCE IN CANADA)
MOTOR HOME SERIAL NUMBER
VEHICLE CHASSIS IDENTIFICATION NO. (VIN)
DATE OF DELIVERY TO FIRST RETAIL PURCHASER
VEHICLE MILEAGE AT TIME OF DELIVERY
SELLING DEALER NAME AND ADDRESS

**TANK CAPACITIES**



**Chassis Fuel Tank** .....21.1 gal.



**LP Gas Tank** ..... \*5.6 gal. (7 gal. w.c.)



**Fresh Water Tank** ..... 16 gal.



**Water Heater** .....4 gal.



**Black Water Holding Tank (Toilet, Shower & Lavatory)** ..... 13 gal.



**Gray Water Holding Tank (Galley & Shower)**  
 Model 22QD .....9 gal.  
 Model 22FD ..... 6 gal.  
 Model 22HD ..... 7 gal.



**Tire Pressure**..... See Vehicle Certification Label on driver's door pillar.

**Rear Suspension Pressure** .....20-30 psi

# Rialta

## TABLE OF CONTENTS

---

### INTRODUCTION

About This Manual .....	0-1
Chassis Owners Manual .....	0-1
Owner's InfoCase .....	0-1
Before Driving .....	0-2
Service Assistance .....	0-2
Warranty .....	0-2
Drinking and Driving .....	0-2
Reporting Safety Defects .....	0-2
Vehicle Certification Label .....	0-4
Exterior Feature Identification .....	0-5

### SECTION 1: SAFETY PRECAUTIONS

General Warnings .....	1-1
Driving .....	1-1
Fuel & LP Gas .....	1-2
LP Gas Leaks .....	1-3
LP Gas Alarm .....	1-3
Electrical .....	1-4
Loading .....	1-4
Maintenance .....	1-4
Formaldehyde Warning .....	1-5
Carbon Monoxide Warning .....	1-5
Carbon Monoxide Alarm .....	1-6
Emergency Exit Window .....	1-6
Fire Extinguisher .....	1-7
Smoke Alarm .....	1-7

### SECTION 2: DRIVING YOUR MOTOR HOME

Before Entering Your Vehicle .....	2-1
Before Driving Your Vehicle .....	2-1
Keys .....	2-2
Fuel Selection .....	2-2
Gasoline Fuel Fill .....	2-2
Fuel Tank Capacity .....	2-2
Starting and Stopping Engine .....	2-2
Entrance Door Lock and Handle .....	2-2
Driver Compartment Door Locks .....	2-3
Driver and Co-Pilot Seats .....	2-3
Companion Seats .....	2-4
Lounge Seat .....	2-5
Seat Belts .....	2-5
Care and Cleaning .....	2-6
Child Restraints .....	2-6
Mirrors .....	2-6

Instrument Panel Gauges & Controls .....	2-7
Steering Column Controls .....	2-7
Radio Cassette Player .....	2-7
Auxiliary Start Switch .....	2-7
Auto Air Conditioner/Heater .....	2-7
Auxiliary Rear Automotive Heater .....	2-7
Auxiliary Automotive Air Conditioner .....	2-8
Rear Window Defogger .....	2-8
Rear Wiper/Washer .....	2-9

### SECTION 3: IN CASE OF DRIVING

#### EMERGENCY

If You Get A Flat Tire .....	3-1
Motor Home Jacking & Tire Changing .....	3-1
Wheel Mounting Bolts (Lug Bolts) ...	3-1
Tire Changing Safety Precautions .....	3-1
Recovery Towing .....	3-2
Engine Overheat .....	3-2
Jump Starting .....	3-3
Connecting a Battery Charger .....	3-3

#### SECTION 4: TRAVELING WITH YOUR MOTOR HOME

Loading the Vehicle .....	4-1
Front Axle Tire Alignment .....	4-1
Weighing Your Loaded Vehicle .....	4-1
Maximum Occupancy .....	4-2
Roof Loading .....	4-2
Rear Bumper Loads .....	4-2
Trailer Towing .....	4-2
Pre-Travel Checklist .....	4-2
Travel Tips .....	4-3
Severe Weather Information .....	4-4
Nighttime Driving .....	4-5
Mountain Driving .....	4-5
Campsite Set-Up .....	4-5
Blocking .....	4-5
Effects of Prolonged Occupancy .....	4-6
Humidity and Condensation .....	4-6

#### SECTION 5: LP GAS SYSTEM

LP Gas Supply .....	5-1
Safe Use of LP Gas System .....	5-1
How LP Gas Works .....	5-1
Selecting Fuel Types .....	5-2

---

LP Tank System ..... 5-2  
 LP Tank Capacity ..... 5-2  
 Refilling Tank ..... 5-2  
 Air in the LP Gas Tank ..... 5-3  
 Travel with LP Gas ..... 5-3  
 Regulator ..... 5-3  
 LP Gas Leaks ..... 5-4  
 LP Gas Alarm ..... 5-4  
 Winter Use of LP Gas ..... 5-4

**SECTION 6: ELECTRICAL SYSTEMS**

110-Volt AC System ..... 6-1  
 External Power Cord (Shoreline) ..... 6-1  
 Power Load Center ..... 6-2  
 Power Converter ..... 6-3  
 Charging Section ..... 6-3  
 Thermal Overload Protector ..... 6-3  
 110-Volt Circuit Breakers ..... 6-3  
 110-Volt Receptacles (Outlets) ..... 6-4  
 Ground Fault Circuit Interrupter  
 (GFCI) ..... 6-4  
 Auxiliary 110-Volt Generator  
 Operating Instructions ..... 6-5  
 Stopping and Starting Generator ..... 6-5  
 Operation Warnings & Cautions ..... 6-6  
 12-Volt DC System ..... 6-6  
 Automotive (Starting) Battery ..... 6-6  
 Coach Battery ..... 6-6  
 12-Volt Fuses and Circuit Breakers ..... 6-7  
 Fuse Panel ..... 6-7  
 Coach Battery Access ..... 6-8  
 Battery Storage and Maintenance ..... 6-8  
 Battery Condition Meter ..... 6-9  
 Trailer Wiring Connector ..... 6-9

**SECTION 7: PLUMBING SYSTEMS**

Fresh Water System ..... 7-1  
 Fresh Water Tank Filling ..... 7-1  
 Water Pump ..... 7-1  
 Water Pump Switch ..... 7-2  
 Disinfection of Water Tank ..... 7-2  
 External (City Water) Connector ..... 7-3  
 Water Drain Valves ..... 7-3  
 Water Heater Bypass Valve ..... 7-4  
 Waste Drainage System ..... 7-4  
 Holding Tank Level Indicators ..... 7-5  
 Dumping Holding Tanks ..... 7-5  
 Using On-Side Sewer Hook-Ups ..... 7-6

**SECTION 8: APPLIANCES AND INTERIOR FEATURES**

Refrigerator (3-way powered) ..... 8-1  
 Rialta 22FD & 22QD models ..... 8-1  
 Rialta 22HD models ..... 8-3  
 Leveling ..... 8-1  
 Operating Instructions ..... 8-2  
 Range Top ..... 8-3  
 Microwave Oven ..... 8-3  
 Monitor Panel ..... 8-3  
 Water and Holding Tank Levels ..... 8-4  
 LP Gas Level ..... 8-4  
 Water Pump Switch ..... 8-4  
 Battery Condition Meter ..... 8-4  
 Electric Water Heater ..... 8-4  
 Electric Water Heater Maintenance ..... 8-6  
 Water Heater Pressure Temperature  
 Relief Valve ..... 8-6  
 Motor Aid ..... 8-7  
 LP Gas Furnace (Suburban) ..... 8-7  
 Operating Instructions ..... 8-8  
 Roof Air Conditioner ..... 8-8  
 TV Antenna ..... 8-8  
 TV Signal Amplifier ..... 8-9  
 Checking Performance ..... 8-9  
 Cable TV Hook-Up ..... 8-10  
 Dinette Table ..... 8-10  
 Sleeping Facilities ..... 8-10  
 Compact Bath Compartment ..... 8-12  
 Fresh Water Toilet ..... 8-12  
 Cleaning the Toilet ..... 8-12  
 Fold-Up Lavatory Sink ..... 8-13  
 Compact Shower ..... 8-13  
 Crank-Out Side Windows ..... 8-15  
 Power Roof Vent (Optional) ..... 8-15  
 Day/Night Pleated Window Shade ..... 8-16

**SECTION 9: CARE AND MAINTENANCE**

Roof ..... 9-1  
 Underbody ..... 9-1  
 Body Finish ..... 9-1  
 Stripes and Decals, care of ..... 9-2  
 Interior Maintenance  
 Upholstery, Carpeting and  
 Draperies ..... 9-2  
 Carpet and Cleaning ..... 9-2  
 Spots and Stains ..... 9-2  
 Vinyl Fabrics ..... 9-2  
 Draperies, Curtains and Bedspreads .. 9-3

Cabinetry .....	9-3
Vinyl Wallboard .....	9-3
Tables and Countertops .....	9-3
Stainless Steel Sink .....	9-3
Range and Refrigerator .....	9-3
Bathroom .....	9-3
Doors and Windows .....	9-3
Window, Roll-up Shade Adjustment .	9-4
Vehicle Maintenance	
Chassis Service and Maintenance .....	9-4
Engine Access .....	9-4
Engine Cooling System .....	9-4
Rear Window Washer Reservoir	
Level Check .....	9-4
Tire Pressure and Condition .....	9-5
Tire Replacement Information .....	9-5
Wheel Replacement	
Recommendations .....	9-6
Suspension Alignment and Tire	
Balance .....	9-6
Care of Custom Aluminum Wheels ...	9-7
Rear Air Springs .....	9-7
<b>SECTION 10: STORING YOUR MOTOR</b>	
<b>HOME</b>	
Preparing Vehicle for Storage .....	10-1
Cold Weather Storage Procedure	
(Winterizing) .....	10-1
Removal from Storage .....	10-3

---





Congratulations on the purchase of your new Rialta motor home, which has been carefully designed, engineered and quality built by Winnebago Industries, Inc.



### ABOUT THIS MANUAL

Please read this operator's manual completely to understand how everything in your coach works before taking it on its "maiden voyage."

This manual is a guide to safe operation of the features, equipment and controls in this coach. Some equipment, such as the vehicle chassis and certain electronic systems or appliances, have their own comprehensive, manufacturer supplied manuals or information sheets which describe operation of these products in great detail. This manual will refer you to the manufacturer's information included in your Owner *INFOCASE* whenever necessary.

**SUBJECT ICONS** - To make it easier for you to find information you're looking for, we have placed convenient, pictorial symbols called "icons" beside many of the subject headings in this manual. The icons correspond to the subject matter of the section. These icons were designed similar to the familiar international symbols which identify public facilities such as restrooms and handicap access. There are several examples of icons on this page.

**PAGE ICONS** - The icons at the upper corners of each page correspond to the primary content of each main section of the manual, such as LP Gas, Electrical, Plumbing, etc. This means you can flip through the manual either forward or backward and know exactly which main section you are looking for just by watching the icons at the top of the page. This means less paging back and forth.

**We also urge you to read the complete Chassis Operating Guide provided by the chassis maker and all other operating information provided by our equipment suppliers and manufacturers.** This is contained in your Owner *INFOCASE*<sup>TM</sup>.

This manual should be kept in the vehicle at all times for personal reference. The operator's manual, *INFOCASE* and chassis operating guide are to be considered permanent components of this vehicle. They should remain in the vehicle when sold to provide the next owner with important safety, operating and maintenance information.

*NOTE: The descriptions, illustrations, and specifications in this manual were correct at the time of printing. We reserve the right to change specifications or design without notice, and without incurring obligation to install the same on products previously manufactured.*



### CHASSIS OWNER'S MANUAL

Throughout this manual, frequent reference is made to the vehicle chassis owner's manual. The chassis manual is the operator's manual provided by Volkswagen, the manufacturer of the chassis on which this motor home is built. Consult the chassis guide for operating safety and maintenance instructions pertaining to the Volkswagen chassis section of the motor home.

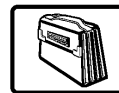

### OWNER'S INFOCASE

Your Owner's InfoCase contains information supplied by manufacturers of individual appliances and equipment installed in your motor home.

Consult this information regarding the operation and care of appliances, accessories and special equipment.

### OPTIONS AND EQUIPMENT

Some equipment and accessories described in this manual may be optional and may not apply to your coach.



**BEFORE DRIVING**

Before sitting in the driver’s seat, always check around your vehicle to be sure you have proper clearance for maneuvering. If necessary, have a passenger help guide you out of a difficult parking space.

Although your coach features automotive conveniences like power steering and power brakes, driving a motor home is different from driving a car. A motor home is larger and heavier than an automobile, so it requires more stopping and passing distance, and more parking and maneuvering space than does a car.

Always be aware of the size of your motor home. The added height of roof air conditioners, TV antennas or luggage boxes may cause clearance problems around some tunnels, canopies and hanging signs. Know the height of your unit so you can observe posted clearance limits. Also, remember that some bridges, old ones in particular, may not support the weight of your motor home. Know the weight of your unit and observe any posted weight limits.

Remember: Always use your seat belt and be sure your passengers do so as well. We also advise making frequent rest stops while traveling to relieve stress on yourself, your passengers and your vehicle.

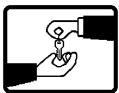

**SERVICE AND ASSISTANCE**

Your Rialta dealer will be glad to provide any additional information you need, as well as answer any questions you might have about operating the equipment in your motor home. When it comes to service, remember that your dealer knows your vehicle best and is interested in your satisfaction. Your dealer will provide quality maintenance and any other assistance that you may require during your ownership of this vehicle.

If you need warranty repairs while traveling, however you may take your motor home to any

Winnebago or Itasca dealership and they will assist you.



**WARRANTY**

Your new vehicle is covered by a factory warranty against defects in material and workmanship. This warranty should be validated immediately and returned to the factory by your dealer. For additional information, see your “New Vehicle Limited Warranty” included with this vehicle.

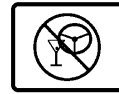

**DRINKING AND DRIVING**

Winnebago Industries supports the recommendations of the Presidential Commission on Drunk Driving.

- Exercise your good judgment and encourage others to do the same.
- Know the legal limits and do not exceed them.
- Also know your personal limits, which may be lower than the legal limits.
- Should you ever exceed your limits, find alternative transportation; call a cab, ask a friend to drive you home or call a family member to come and get you.

The presence of alcohol in significant levels in the blood increases the probability that the driver will be involved in an accident.

**REPORTING SAFETY DEFECTS**

If you believe that your vehicle has a defect which could cause a crash or could cause injury or death, you should immediately inform the National Highway Traffic Safety Administration (NHTSA) in addition to notifying Winnebago Industries, Inc.

If NHTSA receives similar complaints, it may open an investigation, and if it finds that a





safety defect exists in a group of vehicles, it may order a recall and remedy campaign. However, NHTSA cannot become involved in individual problems between you, your dealer, or Winnebago Industries.

To contact NHTSA, you may either call the Auto Safety Hotline toll-free at 1-800-424-9393 (or 366-0123 in Washington, D.C. area) or write to: NHTSA, U.S. Department of Transportation, Washington, D.C. 20590. You can also obtain other information about motor vehicle safety from the Hotline.



VEHICLE CERTIFICATION LABEL

This label contains vehicle identification and other important reference information. The vehicle certification label is located on the sidewall to the left of the steering wheel, or on the driver's door. Never remove or destroy this label.

MANUFACTURED BY



INCOMPLETE VEHICLE MANUFACTURED BY ① MOTOR CORP.

MONTH AND YEAR OF MANUFACTURE: ②

GVWR ④ LB \_\_\_\_\_ KG

GAWR: ③

FRT	LB	KG	TIRE	RIM	PSI	KPA SINGLE
RR.	⑤ LB	KG	⑥	⑦	⑧	⑨ KPA

COLD INFLATION PRESSURE

THIS VEHICLE CONFORMS TO ALL APPLICABLE FEDERAL MOTOR VEHICLE SAFETY STANDARDS IN EFFECT ON THE DATE OF MANUFACTURE SHOWN ABOVE.

SERIAL NO. ⑩ VIN ⑪

TYPE ⑫ MODEL ⑬ COLOR ⑭

EXPLANATION OF DATA

1. Chassis manufacturer.
2. Chassis manufacture date.
3. Month and year of manufacture at Winnebago Industries.
4. Gross Vehicle Weight Rating: Total permissible weight of the vehicle, including driver, passengers, total cargo carried (including all liquids) and equipped with all options.
5. Gross Axle Weight Rating: Total permissible weight allowed for the front, intermediate\* and rear axles (listed in pounds and kilograms).
6. Suitable Tire Choice: Tires recommended to meet handling and safety requirements. When replacing any of the tires on your vehicle, always replace with a tire that meets these specifications.
7. Suitable Rim Choice: Wheel rims recommended to meet handling and safety requirements. When replacing any of the rims on your vehicle, always replace with a rim that meets these specifications.
8. Cold Inflation Pressure: Inflation pressures recommended (while Cold) for the tires originally equipped on your vehicle. These pressure levels must be maintained to assure proper handling, safety and fuel economy.
9. Intermediate\* and Rear Axle Wheel Configuration: Single or Dual.

10. Serial Number: This is the serial number assigned to the completed vehicle by Winnebago Industries.
11. Vehicle Identification Number (VIN): This number identifies the chassis on which the motor home is built.
12. Type: States the NHTSA designated usage classification for your motor home. MPV signifies a Multi-purpose Passenger Vehicle.
13. Model: Lists the Winnebago product model number of your vehicle.
14. Color: Signifies the color code number of the decor used throughout the vehicle. This number is necessary for ordering replacement cushions, curtains, carpet, etc.

\*Intermediate (INT) data applies only to Class-A models equipped with tag axle.



## EXTERIOR FEATURE IDENTIFICATION

Model 222QD shown for illustration purposes only.

Actual locations of features depends on your model and option combinations.

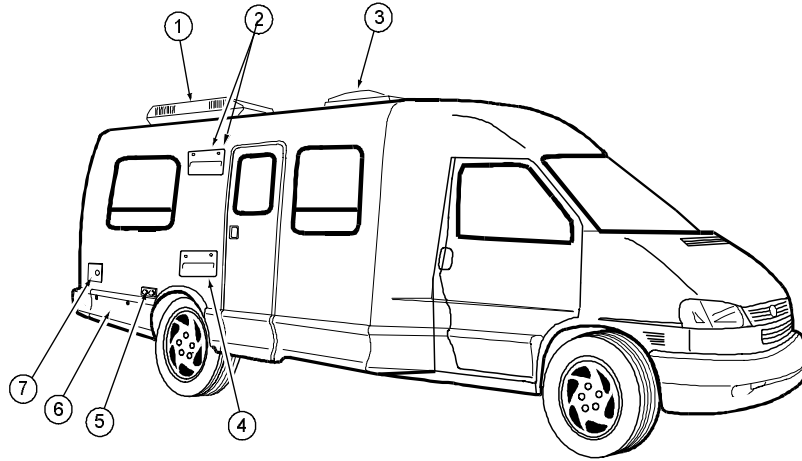

- 1. Roof Air Conditioner Unit
- 2. Refrigerator Exhaust Vent
- 3. Roof Vent/Skylight
- 4. Refrigerator Exhaust Vent

- 5. 110-Volt Outlets
- 6. LP Gas Tank Compartment
- 7. Fresh Water Tank Fill

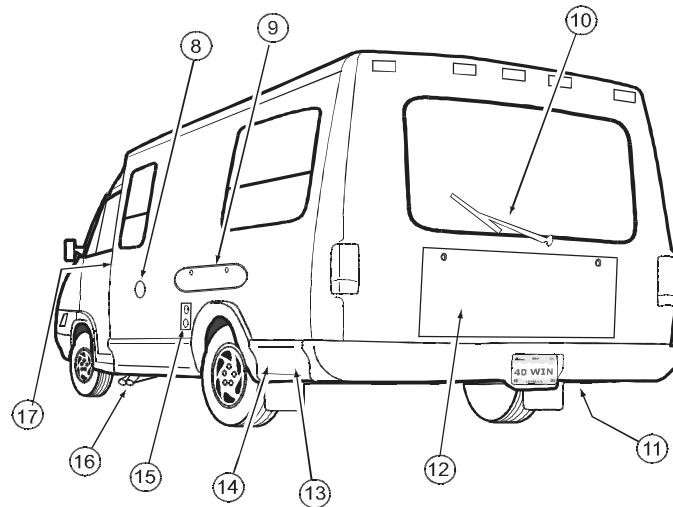

- 8. City Water Connection
- 9. Exterior Wash Station/Shower
- 10. Rear Window Wiper/Washer
- 11. Spare Tire Storage Carrier
- 12. Rear Trunk Storage Compartment\*\*

- 13. Sewer Hose Storage
- 14. Aux. 110-Volt Generator (GenSet)
- 15. Furnace Intake/Exhaust Ports\*
- 16. Holding Tank Dump Valves
- 17. Engine Fuel Fill

**\*CAUTION:** Be careful. These features may become HOT while refrigerator or furnace are in use.

\*\* Also contains shoreline cord storage, generator/shoreline plug in, cable TV connection and rear window washer reservoir.





Read and understand all instructions and precautions in this manual before operating your new motor home. Throughout this manual, certain items are labeled NOTE, CAUTION and WARNING. These terms alert you to precautions that can involve risk to your vehicle or to your personal safety. Read and follow them carefully.

*NOTE: Indicates a special point of information.*

### CAUTION

Indicates that a failure to observe can cause damage to vehicle or equipment

### WARNING

This symbol is used to alert you to precautions that involve your personal safety as well as vehicle damage. Read and follow them carefully.

Listed below are some safety precautions that must be adhered to. These precautions as well as others that involve damage to equipment are also listed in the appropriate areas in this manual.



### GENERAL WARNINGS

- Only seats equipped with seat belts are to be occupied while the vehicle is moving.
- Make sure all passengers have seat belts fastened in a low and snug position so the force exerted by the belt in a collision will be spread across the strong hip area. Place the lap belt across the lap as low on the hips as possible. Pull the retractor belt so that the belt is snug and the mechanism takes up the slack. Pregnant women should wear a lap-shoulder belt whenever possible, with the lap belt portion worn low and snug throughout the pregnancy.

- Never allow passengers to stand or kneel on seats while the vehicle is moving.
- Sleeping facilities are not to be utilized while vehicle is moving.
- Examine the escape window and be familiar with its operation, but do not use except in an emergency.
- Inspect the fire extinguisher monthly for proper charge and operating condition. This should also be done before beginning a vacation or any extended trip.



### DRIVING

- Check and maintain tire pressure per inflation pressures shown on tires. This should be done prior to extended trips and when refueling.
- Do not attempt to adjust the driver's seat while the vehicle is moving.
- Do not adjust tilt steering in a moving vehicle.
- Do not operate the cruise control on icy or extremely wet roads, winding roads, in heavy traffic, or in any other traffic situation where a constant speed cannot be maintained.
- Use care when accelerating or decelerating on a slippery surface. Abrupt speed changes can cause skidding and loss of control.
- Driving through water deep enough to wet the brakes may affect stopping distance or cause the vehicle to pull to one side. Check brake operation in a safe area to be sure they have not been affected. Never operate any



## SECTION 1 SAFETY PRECAUTIONS

*Rialta*

vehicle if a difference in braking efficiency is noticeable.

- Adverse weather conditions and extremes in terrain may affect handling and/or performance of your vehicle. Refer to your chassis manual for related information.



### FUEL & LP GAS



- All pilot lights must be extinguished and appliances turned off while refilling the fuel tank or LP tank.
- Never smoke while refilling vehicle fuel tank or LP gas tank.
- Avoid inhaling exhaust gases produced by burned gasoline, diesel fuel or LP gas in items such as the range, chassis engine, generator engine, refrigerator, furnace and water heater. They contain carbon monoxide, which is an odorless, colorless and poisonous gas.
- Do not bring or store LP gas containers, gasoline or other flammable liquids inside the vehicle because a fire or explosion may result. LP gas containers are equipped with safety valves which relieve excessive pressure by discharging gas to the atmosphere.
- Do not alter the LP gas system at any time or in any way.
- Do not fill LP gas container(s) above 80 percent of capacity. Overfilling the LP gas container can result in uncontrolled gas flow which can cause fire or explosion. A properly filled container will contain approximately 80 percent of its volume as liquid LP gas.
- Never use an open flame to test for LP gas leaks. Replace all protective covers and caps on LP system after filling. Make sure valve is closed and door latched securely.
- Never connect natural gas to the LP gas system.
- When lighting range burners do not turn burner controls to "On" and allow gas to escape before lighting match.
- Portable fuel-burning equipment, including wood and charcoal grills and stoves, shall not be used inside the recreational vehicle. The use of this equipment inside the recreational vehicle may cause fires or asphyxiation.
- LP gas regulators must always be installed with the diaphragm vent facing downward. Regulators that are not in compartments have been equipped with a protective cover. Make sure that the regulator vent faces downward and that the cover is kept in place to minimize vent blockage which could result in excessive gas pressure causing fire or explosion.
- The following warning label is located in the cooking area to remind you to provide an adequate supply of fresh air for combustion.



Unlike large homes, the oxygen supply inside a recreational vehicle is limited due to its size. To avoid danger of asphyxiation, provide proper ventilation when using the gas rangetop or gas oven. It is especially important that the gas oven and range top not be used for comfort heating. Danger of asphyxiation is greater when these appliances are used for long periods of time.



## LP GAS LEAKS

The following label is located in the vehicle near the range area. If you smell gas within the vehicle, quickly and carefully perform the procedures listed.

### IF YOU SMELL GAS

1. Extinguish any open flames, pilot lights and all smoking materials.
2. Do not touch electrical switches.
3. Shut off the gas supply at the tank valve(s) or gas supply connection.
4. Open doors and other ventilating openings.
5. Leave the area until odor clears.
6. Have the gas system checked and leakage source corrected before using again.



## LP GAS ALARM

Your coach is equipped with an LP gas detector which sounds an alarm if an unsafe amount of LP gas is present inside the coach. Because LP gas is heavier than air, the detector is located on the rear galley cabinet face near the floor of the coach.

A green light on the face of the alarm shows when the unit is active. If the detector senses LP gas, the alarm will make a loud, pulsating sound and the red light will come on. Pressing the "MUTE" button will stop the alarm for 60 seconds. If there is no more detectable LP gas, the alarm will stay off. If the detector still senses LP gas by the end of the 60 second mute mode, the alarm will sound again.

Press to Stop Alarm

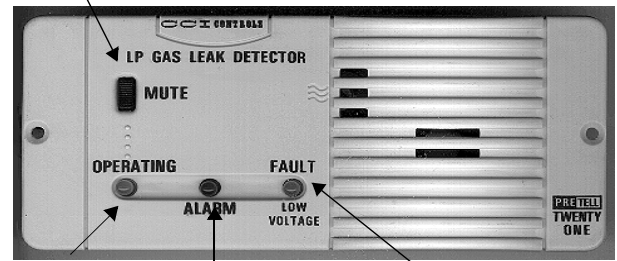

Green  
(Active)

Red  
(Alarm)

Amber  
(Low Batt.)

### If the Alarm Sounds

If the alarm sounds, do not touch any electrical switches. Immediately turn off the main LP tank valve and all LP appliances, open all windows and roof vents, and leave the coach until the alarm stops sounding.

If the alarm keeps sounding at regular intervals, a leak may be present. Contact your dealer or an LP gas service center to have the problem corrected before using the LP system again.

### WARNING

Never use an open flame to test for gas leaks.

When testing for gas line leaks with a soapy water solution, DO NOT use a detergent containing ammonia or chlorine. These substances may generate a chemical reaction causing corrosion to gas lines, resulting in dangerous leak conditions.

### Power Connection

The gas alarm is powered by the coach batteries. If the battery cable is disconnected from the batteries or the fuse is blown, the alarm will not work. The LP gas alarm fuse is located on the power converter fuse panel shown on page 6-6.

If the coach batteries become extremely drained (8.5 volts or less), the amber Low Voltage/FAULT light on the face of the alarm will come on, and in some rare cases the LP alarm may begin to sound on its own. This condition is



## SECTION 1 SAFETY PRECAUTIONS

*Rialta*

not likely to occur except during storage situations when coach battery charge is not being restored by the converter charger.

Because the LP gas alarm is connected directly to the auxiliary battery, it is always drawing a small amount of current. Even though this current draw is slight, it could drain the coach battery during storage periods of 30 days or longer. We recommend disconnecting the battery cables from the auxiliary battery during extended storage periods to avoid discharge.

### Other Combustible Fumes or Vapors

This alarm is designed to detect the presence of LP gas, however there are other combustible fumes or vapors which may be detected by the sensor. These include: alcohol, liquor, deodorants, colognes, perfumes, wine, adhesives, lacquer, kerosene, gasoline, glues, most all cleaning agents and the propellants of aerosol cans. Most are lighter than air in their vapor state and will only be detected when the area is closed up. Glues and adhesives may exhaust hydrocarbon vapors for months after they are applied. They are easily activated by high temperatures. If you close up an RV coach on a hot day, the chemicals used in its construction may be detected for months after the coach was manufactured.

### Further Information

See the manufacturer's information entitled "Your LP Gas Detector" in your Owner/InfoCase for further instructions on nuisance alarms and care and testing of the LP gas detector.



## ELECTRICAL

- Careless handling of electrical components can be fatal. Never touch or use electrical components or appliances while feet are bare, while hands are wet, or while standing in water or on wet ground.
- Improper grounding of the vehicle can cause personal injury. Do not plug the utility power

cord into an outlet which is not grounded and do not adapt the plug to connect to a receptacle for which it is not designed.

- Do not attach an extension cord to the utility power cord.
- Be sure that all electrical appliances to be used contain 3-prong plugs for proper grounding.
- Avoid overloading electrical circuits. Replace fuses or circuit breakers with those of the same size and amperage rating only. Never use a higher rated fuse or breaker.
- Use caution when handling or working near electrical storage batteries. Always remove jewelry and wear protective clothing and eye covering. Avoid creating sparks.

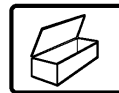

## LOADING

- Store or secure all loose items inside the motor home before traveling. Possible overlooked items such as canned goods or small appliances on the countertop, cooking pans on the range, or free-standing furniture items can become dangerous projectiles during a sudden stop.
- Be aware of GVWR, GAWR and individual load limit on each tire. (See "Loading the Motor Home" in Section 4.)
- Never load the motor home in excess of the gross vehicle weight rating or the gross axle weight rating for either axle.



## MAINTENANCE

- Do not remove the radiator cap while engine and radiator are still hot. Always check cool-





ant level visually at the see-through coolant reservoir.

- Never get beneath a vehicle that is held up by a jack.
- Do not mix different construction types of tires on the vehicle such as radial, bias or belted tires, as vehicle handling may be affected. Replace tires with exact size, type and load range See page 9-5 for tire specifications.
- Do not attempt to start the vehicle by hot wiring.

## FORMALDEHYDE INFORMATION

### WARNING

Although Winnebago did not use formaldehyde based adhesives to manufacture this vehicle, some raw materials used, such as plywood, carpet and fabrics may contain formaldehyde based adhesives which may release formaldehyde fumes into the air for an unknown period of time until total dissipation occurs. Individuals who are allergic to formaldehyde gas fumes may experience irritation to eyes, ears, nose and throat. Although long range effects are not well understood, testing to date has not revealed any serious health effects in humans at the level of emission from these products.

*NOTE: To aid in dissipation, ventilate the vehicle by opening all windows and circulating the air with a fan.*

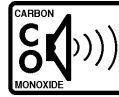

### CARBON MONOXIDE WARNING

#### WARNING

Avoid inhaling exhaust gases, as they contain carbon monoxide, which is a colorless, odorless and poisonous gas.

If you suspect that exhaust fumes are entering the passenger compartment, have the cause determined and corrected as soon as possible. If you must drive under these conditions, drive only with **ALL WINDOWS FULLY OPENED**.

The best protection against carbon monoxide entry into the vehicle body is a properly maintained engine exhaust and ventilation system. It is recommended that the exhaust system and body be inspected by a qualified motor home service center.

- Each time the vehicle is raised for an oil change.
- Whenever a change in the sound of the exhaust system is noticed.
- Whenever the exhaust system, underbody or rear of the vehicle is damaged.

To allow proper operation of the vehicle's ventilation system, keep front ventilation inlet grill clear of snow, leaves or other obstructions at all times. **DO NOT OCCUPY A PARKED VEHICLE WITH ENGINE RUNNING FOR AN EXTENDED PERIOD.**

Do not run engine in confined areas, such as a garage, except to move vehicle in or out of area. When vehicle is stopped in an **UNCONFINED** area with the engine running for any more than a short period, adjust heating or cooling system to force outside air into the vehicle as follows:

1. Set fan to medium or high speed and vent control to air.
2. On vehicles equipped with air conditioning, set fan to medium or high speed and set control to obtain maximum vent air.



## SECTION 1 SAFETY PRECAUTIONS

# Rialta

Rear windows should be closed while driving to avoid drawing dangerous exhaust gases into the vehicle.

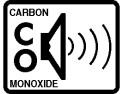

### CARBON MONOXIDE ALARM

Your coach is equipped with a carbon monoxide (CO) alarm, located on the underside of the overhead cabinet above the left rear dinette seat.

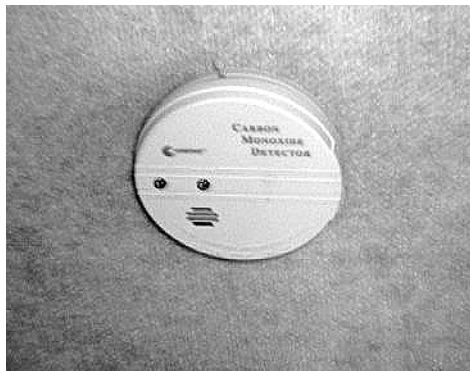

The CO alarm is powered by a 9-volt battery and contains a sensor that is designed to detect toxic carbon monoxide gas fumes resulting from incomplete combustion of fuel. It will detect CO gas from any combustion source such as the furnace, gas range/oven, water heater, refrigerator, chassis engine, and electric generator engine.

### Monthly Testing

Press the TEST button on the face of the alarm periodically (at least monthly) to check the function of the alarm and condition of the battery. If the alarm begins to beep every few seconds, the battery may be weak and need replacement. (Press the TEST button to be sure before replacing the battery. If the alarm sounds, the battery may still be okay. If the alarm still beeps every few seconds, check the smoke detector also. The “low battery” warning beep is similar on many alarm devices, so the origin of this electronic sound can be deceiving.)

### Further Information

Please read the information provided by the manufacturer, which is included in your Owner

InfoCase. It includes information on precautions, operational testing, and battery/sensor replacement.



### EMERGENCY EXITS Emergency Exit Windows

Your motor home is equipped with an emergency exit window in the rear of the vehicle which functions as an escape exit in an emergency situation.

The glass is installed with a rubber extrusion. It is opened by pulling on the red plastic loop, located at the bottom of the window, until the rubber cord is completely removed. This allows the window to be pushed out. Instructions for removal are also located on a label on the glass for quick reference and for passengers who may not be familiar with the exit. Be sure this label is never removed or destroyed.

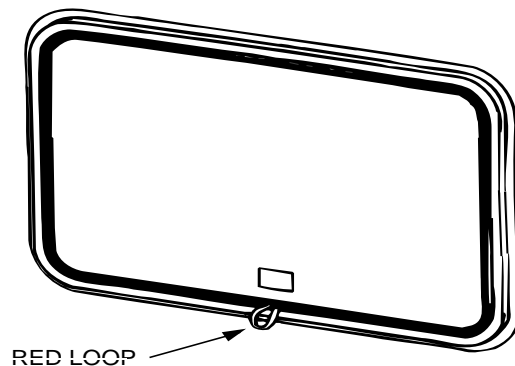

### WARNING

Use emergency window for emergency exit only. Do not test for proper operation.

If the cord is released by accident, but the glass remains in place, the cord can be replaced using a blunt instrument, preferably one made of plastic. We suggest you contact your dealer for assistance.



## WARNING

Use care when exiting emergency window, as broken glass may be present in the exit area.

## WARNING

Do not test the fire extinguisher by discharging it. Partial discharge can cause leakage of pressure or contents which would render the unit inoperative when needed. When using the fire extinguisher, aim the spray at the base of the fire.



## FIRE EXTINGUISHER

A dry chemical fire extinguisher is located near the floor by the side entrance door.



We recommend that you become thoroughly familiar with the operating instructions displayed on the side of the fire extinguisher or in the information supplied in your Owner Info-Case.

We also recommend that you inspect the fire extinguisher for proper charge at least once a month in accordance with National Fire Protection Association (NFPA) recommendations as stated on the label. If the charge is insufficient, the fire extinguisher must be replaced.



## SMOKE ALARM

Your motor home is equipped with a smoke alarm located on the underside of the overhead cabinet above the right rear dinette seat. This alarm meets U.L. Standard 217 and NFPA Standard 74 for operation of smoke detection devices.

1. The smoke alarm should be tested for correct operation each time the vehicle is brought out of storage, before each trip, and at least once a week during motor home use. To test the electronics, firmly depress the button. To test that smoke reaches the sensor, blow smoke in a careful, fire-safe manner into your smoke alarm.



2. Your smoke alarm will not work without power. Never remove the battery to quiet the alarm. When your smoke alarm “beeps” about once a minute the battery is weak. Install a new battery immediately. Be sure to use only batteries specified in manual or on unit. Test unit after installing a new battery.



**SECTION 1**  
**SAFETY PRECAUTIONS**

---

*Rialta*

3. Clean and vacuum the openings on your smoke alarm once a month.
4. Do not open the smoke alarm or try to repair it. For replacement information see warranty in Owner's Manual.
5. Smoke alarms have technical limitations and may not respond in all situations. FIRE PREVENTION is your best safeguard.

See your Owner InfoCase for further information.



(See also Safety Precautions, Section 1 of this manual.)

*NOTE: This section describes only those instruments and controls which are unique to this motor home. For complete information regarding all other equipment, controls and instructions, consult the Volkswagen chassis owner's manual or the individual equipment manufacturer's information provided in your Owner InfoCase. Some items described may be optional or unavailable on your vehicle.*

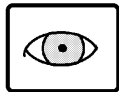

### BEFORE ENTERING YOUR VEHICLE

Before entering your vehicle, there are a few recommended procedures that will aid in your driving safety and equipment.

1. Be sure that the windows, mirrors and light lenses are clean and unobstructed.
2. Make sure all exterior lights operate properly.
3. Check tires for proper cold inflation pressures and inspect for any unusual wear.
4. Check wheel lug nuts for tightness.
5. Look beneath the vehicle for noticeable fluid leakage.
6. Check fluid levels and fill if necessary. This includes engine oil, transmission fluid, coolant, brake fluid, power steering fluid and windshield washer solvent.

#### WARNING

The transmission must be in P (Park) or N (Neutral) and park brake engaged while performing any checks or adjustments.

The engine should be shut off unless specifically required for a certain procedure.

7. Unhook and store sewer and water supply hoses.
8. Retract step.
9. Be sure that all of your cargo is secured in event of a sudden stop or an accident.
10. Check around your vehicle in all directions to assure that you have proper clearance.
11. Lower TV antenna.
12. Disconnect and store shoreline.

#### WARNING

Before driving your vehicle, be sure you have read the entire operator's manual and that you understand your vehicle's equipment completely and how to use the equipment safely.



### BEFORE DRIVING YOUR VEHICLE

Before preparing to drive your vehicle, here are a few recommended procedures that will add to your driving safety and enjoyment.

1. Be sure that you adjust the interior and exterior rear view mirrors to your driving preference.
2. Adjust the driver's seat for proper distance from foot pedals and steering wheel to allow for safety and ease in controlling your vehicle.
3. Place front seats in the forward facing position.
4. Be sure to fasten all safety belts to fit you comfortably, but tight enough to obtain the full safety of the belts.
5. Make sure all doors are completely shut and locked. When the doors are shut and locked, there is less chance of the doors flying open in event of an accident. It also prevents unintentional opening of doors and keeps intruders out of your vehicle.



6. Check to see that all gauges are operating properly.
7. Check the fuel level in the vehicle.
8. Be certain that the fire extinguisher is fully charged and secure in its mounting bracket.

**CAUTION**

Be sure hood and all compartment doors are latched securely before driving vehicle



**KEYS**

Your motor home is supplied with several sets of keys. In addition to the chassis manufacturer's ignition key, you receive keys for front doors, entrance door, and exterior compartment doors.

Each set of keys has an identification number, either a small metal tag or stamped into the key head. Record these numbers and keep them in a safe place. In case keys are lost or stolen, your dealer or a locksmith can provide you with duplicate keys or modify the locks.



**FUEL INFORMATION**

**FUEL SELECTION**

Refer to your Volkswagen chassis owner's manual for the manufacturer's recommendations on proper fuel selection.

**WARNING**

Modern fuel systems may build up pressure within the tank as the gasoline warms during use or in hot weather.

Under certain conditions, sudden release of this pressure when removing the gasoline cap can spray gasoline from the fuel fill opening, causing a possible hazard.

**GASOLINE FUEL FILL**

**REMOVING THE FUEL CAP**

When removing the gasoline cap, slowly rotate it **only far enough to allow pressure to release**. After any "hissing" sounds stop, continue removing the cap.

**FILLING THE TANK**

**Do not overfill the fuel tank.** Allow gasoline to pump into the tank until the auto-shutoff valve in the fuel pump nozzle stops the flow of fuel, indicating a full tank. This provides a pre-determined vapor space at the top of the tank to allow for expansion of the gasoline.

**CAUTION**

Continuing to fill above this level may cause damage to the fuel/evaporative emission system.

**Fuel Tank Capacity:** 21.1 gals.

**REPLACEMENT FUEL CAPS**

To protect gasoline system from excessive pressure or vacuum, or from sudden pressure, replace lost caps with caps of the same design available from your dealer.

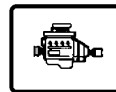

**STARTING AND STOPPING ENGINE**

Refer to your Volkswagen chassis owner's manual for the manufacturer's recommendations on starting and stopping the engine.



**ENTRANCE DOOR LOCK AND HANDLE**

*NOTE: Keys should always be removed when leaving the vehicle. Since doors can be locked without keys, make sure they have been removed from the ignition before locking the driver's compartment.*



The entrance door may be opened from outside the vehicle by pulling the door handle outward. To open the door from inside, pull upward on the door handle. When the door is locked, neither the inside nor the outside door handle can be operated. It can be locked and unlocked from the outside of the vehicle by inserting the key into the lock and turning.

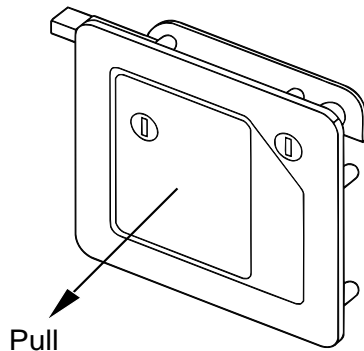

To lock the door from inside, rotate the lock levers as indicated. The deadbolt lock is for added security and should be used as a security night lock.

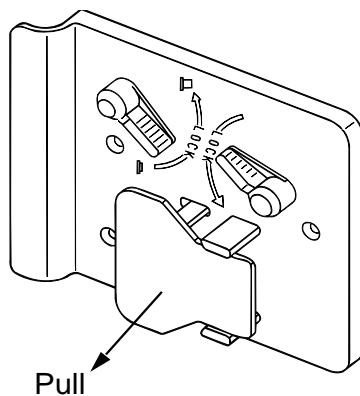

Lubricate the locks periodically with graphite to maintain good working condition.

### CAUTION

When releasing security night lock, be sure to retract bolt before opening door latch to prevent drag on bolt pin. Instruct all passengers in operation of this door catch system as well as emergency exit window.

Never force the inside door handle downward, as damage could occur.

## DRIVER COMPARTMENT DOOR LOCKS

Consult your Volkswagen chassis owner's manual.

### Power Locks

The power locks on the front driver and passenger doors will lock and unlock both front doors and the side entrance door. As is typical for most multi-purpose vehicles, the side entrance door lock can be controlled by the front door power locks, but not vice versa. The side door cannot lock any other door except itself. Before leaving the vehicle by way of the side entrance door, be sure the front doors are locked by pressing one of the front door lock knobs or turning one of the front door key locks.



## DRIVER AND CO-PILOT SEATS

The front seats have slide, recline and swivel features. The seat adjustment controls are located on the lower left side of the seat base.

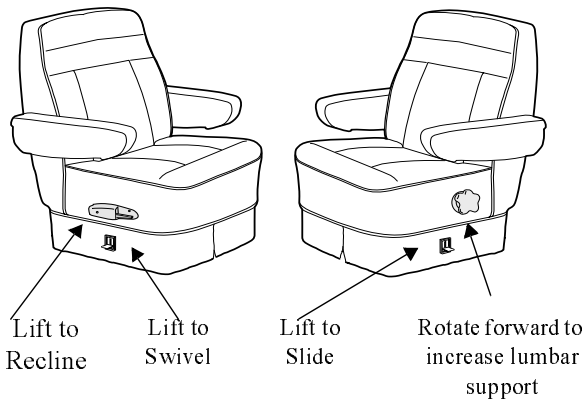

Driver Seat

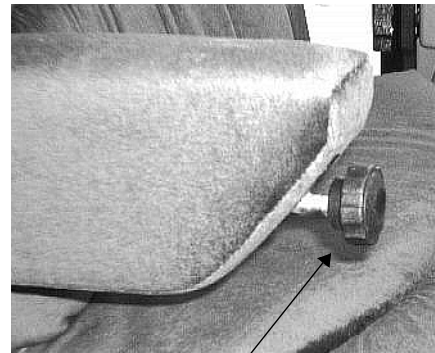

Adjustment Knob

**To Swivel Seats:** Lift the release lever, located on the side of the seat, and rotate seat. The seats are designed to lock only when returned to the forward facing position.

*NOTE: A warning chime will sound when the ignition key is turned on if the passenger seat swivel mechanism is not locked in the forward facing position.*

**To Recline Seats:** Lift the reclining lever, lean back to desired incline and release the lever. To return to the upright position, lift the lever and lean body forward. Allow the seat to return to the desired position and release the lever.

**To Adjust Lumbar Support (driver seat only):** Turn the knob on the left side of the seat forward to increase support and rearward to decrease support.

**To Adjust Armrest Position (driver seat only):** Turn the knob at the front end of the armrest clockwise (tighten) to raise armrest position and counterclockwise (loosen) to lower arm position.

### **WARNING**

Do not adjust driver's seat while vehicle is in motion.

After adjusting seat, always use body pressure to make sure slide and swivel locking mechanism have engaged.

Be sure all swivel seats are locked in the forward facing position while the vehicle is in motion.

Only seats equipped with seat belts are to be occupied while the vehicle is in motion.

### **COMPANION SEATS - Model 222QD**

The companion seats not only provide additional passenger seating, but can be converted to sleeping facilities as well. See Companion Seat/Bed Conversion on page 8-11 for complete instructions.

Storage compartments are located beneath the companion seats. The passenger side seat has a door on the rear. The driver side seat has a door on the aisle side.

### **Seat Back Adjustment (Recline)**

The angle of the companion seat back can be adjusted to three positions:

- Lift front of seat cushion up and pull forward.





- Lower seat cushion while positioning the side pegs into the angled notches on the seat rails. NOTE: Notches to be used depends on angle of recline desired. The farther forward, the greater the angle of recline.

## LOUNGE SEAT - Models 222FD & 222HD

The swivel/slider lounge seat provides additional passenger seating.

The swivel will lock in the center facing position for your safety while the vehicle is moving.

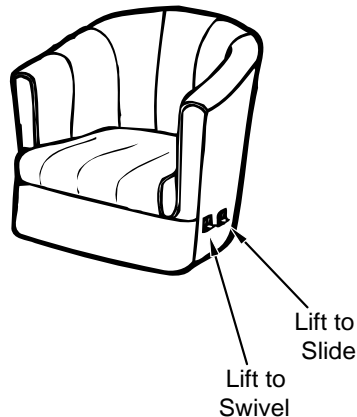

**Swivel:** Pull up on the swivel lever located on the lower left hand side of the seat. The seat will lock into place whenever it reaches the center aisle facing position.

Always return the seat to the aisle facing position for proper use of seat belts while traveling.

**Slide:** Pull up on the slide lever located on the lower left hand side of the seat. Slide to the desired position and release the lever.

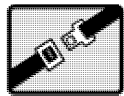

## SEAT BELTS

Seats intended for occupancy while the vehicle is in motion are equipped with seat belts for the protection of the driver and passengers. The lap belts must be worn as low as possible and fit snugly across the hip area. Always sit erect and well back into the seat. To gain full protection of the safety belt, never let more than one person use the same safety belt at any one time, and do not let the safety belts become damaged by pinching

them in the doors or in the seat mechanism. After any serious accident, any safety belts which were in use at the time should be replaced.

## To Fasten and Adjust

The 3-point seat belts in your coach are equipped with automatic locking retractors that let you easily adjust your seat belt to the proper length for passenger safety.

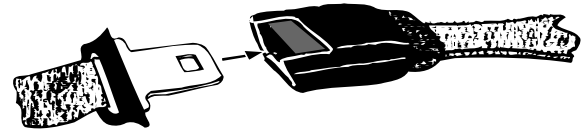

PRESS  
TO  
RELEASE



- Grasp the end of the belt and pull smoothly outward from the seat to the required length, then insert into buckle. Be sure belt is not twisted before fastening.
- Feed any excess belt length back toward the seat so the belt retractor will lock the belt at the proper length for your body when released.
- Do not jerk the belt or pull out too quickly because it will lock prematurely and require you to reset the belt retractor.
- Reset the belt retractor by letting the belt go all the way back to the starting point, then pull slowly and smoothly outward.

## To Release:

Depress button on end of buckle and pull belt out of buckle.

Hold onto the tongue when you release it from the buckle to keep it from retracting too rapidly.



**WARNING**

Snug and low belt positions are essential. This will ensure that the force exerted by the lap belt in a collision is spread over the strong hip area and not across the abdomen, which could result in serious injury.

Only seats equipped with seat belts are to be occupied while vehicle is in motion.

When the lap-shoulder belt is in use, the lap portion must ride across the strong hip area and the shoulder portion must ride diagonally over the shoulder blade toward the buckle.

The shoulder belt is designed to lock only during a sudden stop, sudden body movement or a collision. At all other times it will move freely with the occupant.

**WARNING**

Never wear the shoulder belt in any position other than as stated above. Failure to do so could increase the chance or extent of injury in a collision.

**CARE AND CLEANING**

- Be careful not to damage the belt webbing and hardware. Take care not to pinch them in the seat or doors.
- Inspect the belts and hardware periodically. Check for cuts, frays, and loose parts. Damaged parts should be replaced. Do not remove or modify the belt system.
- Keep belts clean and dry. If the belts need cleaning, use only a mild soap and water solution. Do not use hot water. Do not use abrasive cleaners or bleach. These products may weaken or damage the belts.
- Replace any belt assembly that was used during a severe impact. Replace the complete assembly even if damage is not apparent.



**CHILD RESTRAINTS**

All 50 of the United States and the District of Columbia now require the use of the child/infant restraint systems for children in vehicles.

A properly installed and secured child restraint system can help reduce the chance or severity of personal injury to a child in an accident or during a sudden maneuver. Children may be injured in an accident if they are not seated in a child restraint which is not properly secured.

A child restraint system is designed to be secured in a vehicle seat by a lap belt or the lap belt portion of a lap-shoulder belt. According to accident statistics, children are also safer when properly restrained in rear seating positions than in front seating positions.

When purchasing a child restraint system:

1. Look for the label certifying that it meets all applicable U.S. Federal Motor Vehicle Safety Standards (FMVSS) or, in Canada, requirements of the Children's Car Seats and Harnesses Regulations (CCSHR).
2. Make sure that it will attach to your vehicle and restrain your child securely and conveniently so that you are able to install it correctly each time it is used.
3. Be certain that it is appropriate for the child's height, weight and development. The instructions and/or the regulation label attached to the restraint typically provides this information.
4. Review the instructions for installation and use of the restraint. Be sure that you understand them fully and can install the restraint properly and safely in your vehicle.

**Child Restraint Tether Anchors - Model 22QD**

Most new child restraint (CR) seats for cars now offer safety tether straps to reduce injuries caused by forward movement of the CR seat. These tethers hook into ceiling-mounted anchor points located in the ceiling behind each rear seat.

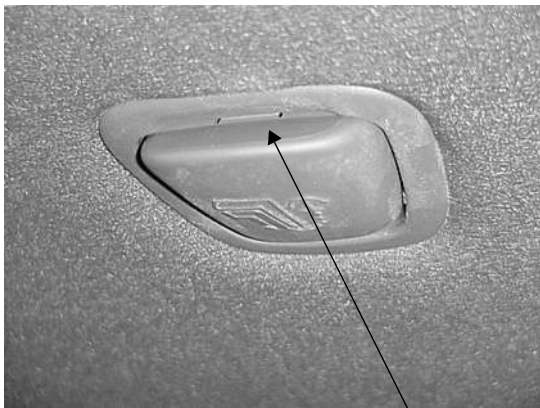

Pull front of cover down to access CR Tether Anchor

- Fasten the CR with seat belts as prescribed by manufacturer.
- Adjust the tether strap for proper length and tension. (See the CR manufacturer's information for specific instructions.)
- Pull the anchor cover down to access the anchorage loop.
- Hook the tether strap onto the loop shown.



Hook CR tether into Tether Anchor loop.



## MIRRORS

Always adjust mirrors for maximum rear visibility before driving off. Make sure the seat is adjusted for proper vehicle control and that you

are sitting back squarely into the seat.

See your Volkswagen owner's manual for instructions on adjusting power mirrors.



## INSTRUMENT PANEL GAUGES AND CONTROLS

See your Volkswagen owner's manual for detailed information on Volkswagen instrument gauges, vehicle controls and other Volkswagen original equipment.

## STEERING COLUMN CONTROLS

See your Volkswagen owner's manual for all controls located on the steering column or steering wheel.

### WARNING

Do not operate the cruise control on icy or extremely wet roads, winding roads, in heavy traffic, or in any other traffic situation where a constant speed cannot be maintained.



## RADIO/CASSETTE PLAYER

Most models are available with a standard AM/FM radio/cassette player or optional AM/FM/CD player to provide high quality stereo sound for your traveling and living enjoyment. Refer to your Owner InfoCase for operating and care instructions.

## AUXILIARY START SWITCH

The auxiliary start switch can be used to provide emergency starting power to engine starter from the coach battery if the automotive battery is dead or too weak to start the engine. The auxiliary start switch is located on the overhead console in the headliner above the rearview mirror.



Aux. Start Switch

Press and hold the switch while turning the ignition key to the start position to temporarily route power from the coach battery to the engine starter. When you release the switch, the coach battery is no longer connected to the starter.

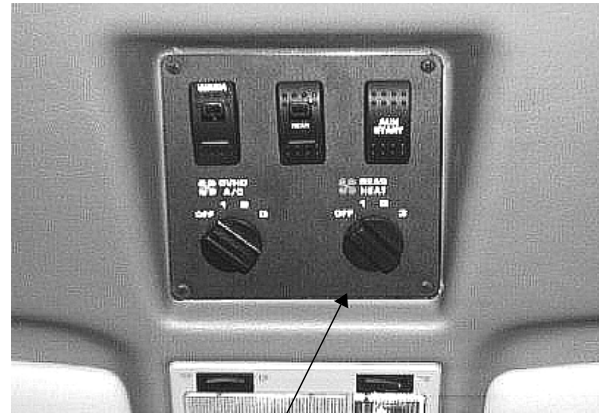

Rear Heater Fan Control

**Temperature Control (Model 22QD & 22HD)**

The temperature control is located on the face of the wardrobe cabinet. Turn the knob counter clockwise (to the left) to increase temperature and clockwise (to the right) to lower the temperature.

To shut heat off, turn the knob completely to the cold side and turn the dash switch to OFF.



**AUTO AIR CONDITIONER/HEATER**

See your Volkswagen Owner's Manual for operating instructions for dash mounted automotive heater-air conditioner controls.

*NOTE: The automotive air conditioner is not designed to cool the entire interior of the motor home, but is intended to cool the driver's compartment only.*

**REAR AUTOMOTIVE HEATER**

The rear automotive heater supplies heat to the rear portion of the coach while driving. The fan is controlled by a 3-speed rotary switch. The rear heater fan speed control is located on the overhead console in the headliner above the review mirror.



Rear Heater Temperature Control  
(Model 22QD & 22HD)

*NOTE: Model 22FD has a ducted rear heater system that does not require a separate rear temperature control.*

**AUXILIARY AUTOMOTIVE AIR CONDITIONER**

The auxiliary air conditioner is mounted in the cab headliner, with four vents aiming toward the rear area of the coach. The dash-mounted



automotive A/C must be on for the overhead A/C to operate. The A/C fan speed control is located on the overhead console in the headliner above the rearview mirror.

Temperature is controlled by the automotive air conditioner lever on the dash. See your Volkswagen owners manual for instructions on auto air conditioner operation.



Overhead A/C Fan Control



Rear Defogger Switch

*NOTE: The rear window defogger is not designed to melt heavy snow or ice. Always remove snow and ice before driving off.*

### Energy Tip

Turn off any electrical items or accessories (lights, fans, defoggers, etc.) when not being used. This reduces fuel consumption by cutting down electrical load on the automotive alternator. When the load increases, the electrical “pull” on the alternator causes the engine to work harder also, increasing fuel consumption.

## REAR WINDOW DEFOGGER

The rear window defogger works only when the ignition switch is on. The rear defogger switch is located on the overhead console in the headliner above the rearview mirror.

To use the rear window defogger, press the switch and release. A small light in the switch will light up to alert you when the defogger is on.

The defogger has an electronic timer that will turn the defogger grid off automatically after 10 minutes of operation. You may also turn the defogger off when the window is clear by pressing the switch to the off position.

## REAR WIPER/WASHER

The optional rear window wiper/washer is controlled by a single-speed rocker switch on the overhead console in the headliner above the rearview mirror. To turn the wiper on or off, press the switch and release.



Rear Wiper/Washer Switch

To use the rear washer, press and hold the switch for as long as needed. The washer will stop when you release the switch. The wiper will continue until you turn the switch off.

The rear washer fluid reservoir is located in the trunk compartment. (See Introduction page 0-4.)





### IF YOU GET A FLAT TIRE

#### In case of sudden tire failure:

- Hold the steering wheel firmly.
- Apply brakes moderately. Do not “jam on” brakes.
- Slow down gradually and pull slowly to a safe off-road place.
- Park on a level spot if possible.
- Turn off the engine.
- Set the parking brake.
- Turn on the hazard warning flashers.
- See your Volkswagen Owner’s Manual for specific tire changing instructions and precautions.

*NOTE: The spare tire is a size 195/65R16C like the front tires. The spare tire may be used on a rear position **if inflated to 65 psi**. However, you should re-install a size 215/65R16C on the rear position as soon as possible.*

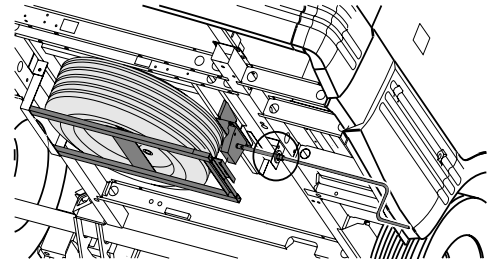

Spare Tire Storage Hoist  
(Under passenger side rear corner)

### WARNING

We advise you to obtain qualified road service whenever possible. Do not try to change a tire yourself except under emergency conditions, and only by closely following instructions in this manual and the chassis operating guide.

If you do satisfactorily complete an emergency tire change, we recommend that you have the wheel nuts checked and properly torque tightened by qualified service personnel as soon as possible.

After a wheel has been properly torqued and inspected by qualified service personnel, it should be rechecked after traveling 100 miles, then again at each oil change.

### SPARE TIRE STORAGE

The spare tire is stored in a swing-down cradle hoist assembly beneath the LP tank near the right rear of the vehicle.

### JACKING AND TIRE CHANGING

Follow the recommendations for jacking and tire changing below.

The jack and lug wrench are stored in the floor compartment ahead of the companion seats.

A jack is designed for use as a tool for changing tires only, not for use as a leveling device or as a support for service purposes.

### Wheel Mounting Bolts (Lug Bolts)

The mounting bolts for the standard steel wheels and optional aluminum wheels are designed specifically to the type of wheel. See photo below.

- The 1-piece bolt for aluminum wheels has a bright plated finish and is 71 mm (about 2 3/4”) long.
- The 2-piece bolt for steel wheels has a rotating “ball” washer, dull grey finish and is 61.6 mm (about 2 3/8”) long.

Be sure to use the proper bolt for the wheel you are mounting.

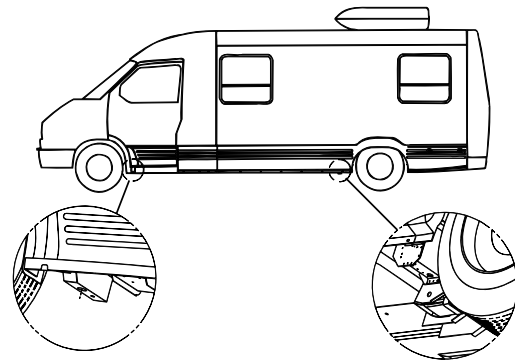
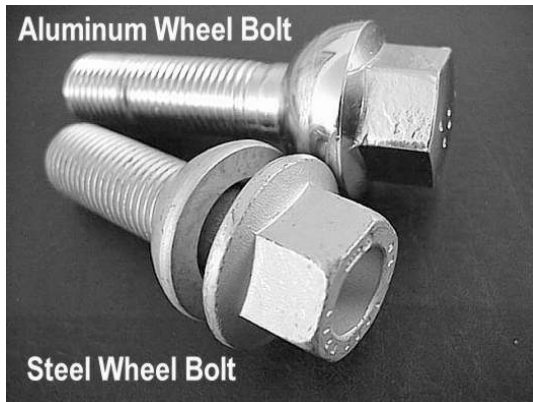

Front Jacking Point (Both Sides)

Rear Jacking Point (Both Sides)

**WARNING**

If mounting a steel wheel in place of an aluminum wheel for any reason, you must use the shorter steel wheel lug bolts to avoid interference with non-moving parts.

Likewise, if mounting an aluminum wheel in place of a steel wheel, you must use the longer aluminum wheel lug bolt to ensure proper thread engagement.

**WARNING**

Do not crawl under the vehicle when it is supported by a jack.

**TIRE CHANGING SAFETY PRECAUTIONS**

Before attempting to change either the front or rear tires, the following precautions should be heeded:

1. Park vehicle on level surface only.
2. Turn off engine and set parking brake.
3. Activate hazard warning flasher.
4. Block both front and back of wheel opposite wheel to be removed.
5. On soft ground, use a board or other material under jack as a firm base to ensure that the jack will not shift.



**RECOVERY TOWING**

See Volkswagen owner's manual for proper recovery towing procedures.

Winnebago Industries does not assume responsibility for damage incurred while towing this vehicle.

**WARNING**

Stay out from beneath the motor home while it is suspended by the towing assembly unless the vehicle is adequately supported by safety stands. Do not allow passengers to occupy a towed vehicle.

*NOTE: Know and obey all state and local towing regulations. Tow at reduced speed.*



**ENGINE OVERHEAT**

If you see or hear steam escaping from the radiator or the engine compartment or have any other reason to suspect an extreme engine over-





heating condition, pull the vehicle over to the roadside as soon as it is safe to do so, stop the engine and get out of the vehicle.

For further information and instructions in case of engine overheating, consult your chassis owner's guide.

### WARNING

Operating a vehicle under a severe overheating condition can result in damage to the vehicle and may result in personal injury.

### WARNING

Automotive batteries produce caustic acid, explosive gases, and electrical current which may cause burns. It is important that the instructions below are followed **exactly**, or personal injury (particularly to eyes) or property damage may result due to battery explosion, battery acid, or electrical (short circuit) burns.

- NEVER smoke near the battery or expose it to open flame or electrical sparks.
- Wear eye protection or shield your eyes while working near battery, in case an explosion does occur. NEVER lean over a battery.
- Do not allow battery fluid to contact eyes, skin, clothing, or painted surfaces. Immediately flush any contacted area with water. If eyes are affected, seek medical help after flushing.
- Remove all metal jewelry to lessen the risk of a short circuit occurring.

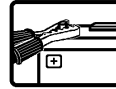

## JUMP STARTING

See the Volkswagen owner's manual for jump starting procedures and recommendations.

---

## CONNECTING A BATTERY CHARGER

See the Volkswagen owner's manual for procedures and recommendations on connecting a battery charger to the automotive (starting) battery.





(See also SAFETY PRECAUTIONS, Section 1 of this manual.)



### LOADING THE VEHICLE

Your cargo capacity will vary according to the options equipped on your vehicle, and your additional equipment and components not supplied with the vehicle. **Do not** exceed any of the recommended weight ratings.

*NOTE: We recommend that you dump all holding tanks before traveling to avoid carrying unnecessary weight.*

When loading the vehicle, distribute cargo load equally so that you do not exceed either the Front or Rear Gross Axle Weight Rating (GAWR) or the Gross Vehicle Weight Rating (GVWR). The Gross Axle Weight Rating (GAWR) means the weight value specified by the chassis manufacturer as the load carrying capacity of a single axle system as measured at the tire-to-ground interfaces. This is the total weight a given axle is capable of carrying. Each axle has its own rating.

Have your vehicle weighed to determine the proper load distribution for your vehicle. Also distribute cargo side-to-side so the weight on each tire or dual set does not exceed one half of the GAWR for either axle. (See “Weighing Your Loaded Vehicle” following this section.)

For example, if the Front GAWR is 4,000 lbs. there should be no more than 2,000 lbs. on each tire. (If the left side weighs 2,100 lbs. and the right side weighs 1,700 lbs., at least 100 lbs. of the load should be shifted from the left side to the right side.) The GVWR is listed on the Vehicle Certification Label. (See page 0-3).

### CAUTION

The weight of the loaded vehicle (including options, attachments, passengers, water, fuel, luggage and all other cargo) must not exceed the GVWR or GAWR of either axle.



### FRONT AXLE TIRE ALIGNMENT

We recommend that you have the front suspension and steering alignment be checked and adjusted after you have fully loaded the vehicle according to your needs. Thereafter, alignment should be periodically inspected to maintain vehicle steering performance and to prevent uneven tire wear.



### WEIGHING YOUR LOADED VEHICLE

To check the weight of your fully loaded coach, locate a commercial weighing scale that is capable of weighing large trucks.

Drive the entire coach onto the scale. This weight should not exceed the Gross Vehicle Weight Rating (GVWR) specified on the Vehicle Certification Label near the driver seat. (See sample on page 0-4).

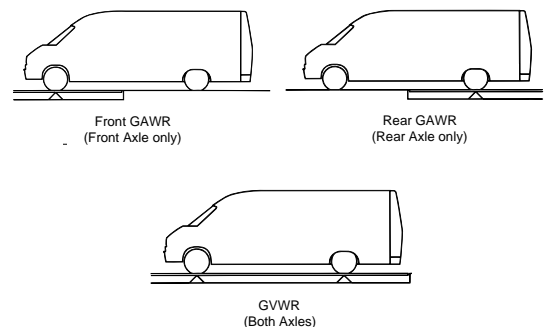



## SECTION 4 TRAVELING WITH YOUR MOTOR HOME

*Rialta*

To determine the weight on either the front or rear axle, drive that axle only onto the scale. Neither axle weight should exceed the corresponding maximum axle weight rating specified on the certification label.



### MAXIMUM OCCUPANCY

The following label is placed in a visible location in the driver compartment.

**BELTED SEATING POSITIONS MAY EXCEED SLEEPING CAPACITY OF THIS VEHICLE. SEE OWNERS MANUAL FOR OCCUPANCY AND WEIGHT RESTRICTIONS.**

The number of belted seating positions in your motor home may exceed the number people used to determine maximum coach occupancy, called the Net Carrying Capacity (NCC) in the U.S. or Cargo Carrying Capacity (CCC) in Canada.

To calculate the NCC or CCC, Winnebago uses vehicle sleeping capacity, however your coach may be equipped with more belted seating positions than sleeping positions to give passengers a choice of seating arrangements. You may use all of the belted seating positions providing you stay within your vehicle's GVWR listed on the Vehicle Certification Label (see page 0-3). However you use or load your vehicle, it is your responsibility to keep the weight within its stated gross vehicle weight rating



### ROOF LOADING

When the vehicle is stationary, the roof will support a 225 pound (maximum) person for the purpose of conducting roof inspection and roof maintenance.

### REAR BUMPER LOADS

The rear bumper is not intended to be used for attaching load carrying brackets because cargo items may cause overloading.

However, if it is necessary to attach load carrying devices to the vehicle, use the frame members for added support.



### TRAILER TOWING

This coach may be equipped with a Class I (2,000 lb.) trailer hitch.

*NOTE: Volkswagen specifies certain weight limitations and reductions for altitudes above 3000 ft., steep grades more than 6% and ambient temperatures above 90° F. See the "Vehicle Operation" section in your Volkswagen chassis owner's manual.*



### PRE-TRAVEL CHECK LIST

Before starting the engine to leave on a trip, be sure your motor home has been properly prepared and maintained. This will ensure an enjoyable trip and help avoid delays. Use this checklist as a guide.

- Fluid Levels - Check and fill if necessary:
  - engine oil
  - transmission
  - power steering
  - radiator
  - brake
  - battery
  - windshield washer
- Wheel Lug Nuts - Check for tightness.
- Tires - Check for proper cold inflation pressures as specified on the Vehicle Certification Label.
- Drive Belts - Check for proper condition and tension (not cracked, frayed, or loose, etc.)
- 110-Volt Generator (Optional) - Check oil level in generator engine.



### WARNING

Never check oil level in generator while engine is operating.

- Fire Extinguisher - Make sure it is fully charged and secured in mounting bracket.
- Lights - Make sure all exterior lights operate.
- Sewer and Water Supply Hose - Unhook and store.
- TV Antenna - Make certain the TV antenna is lowered and seated in its support cradle.
- Loose Items Inside the Motor Home - Store or secure items.
- Pilot Lights - Make sure all pilots are off.
- Fuel Tanks - Check level.
- Water Tank - Fill with fresh water.
- Exterior Door - Make sure doors are closed and locked.
- Seats - Adjusted for comfortable position and locked in place.
- Mirrors - Adjust for maximum visibility from driver's seat.

Remember, it is important to distribute weight and store all heavy items near the floor.

---

### TRAVEL TIPS

As you travel around the country in your motor home, you will pick up useful advice from other motor home owners.

A number of suggestions can also be obtained by reading articles and regular columns in outdoor and camping magazines. Some magazines and publishing companies print an annual park and campground directory. These can be found at your local news stand or RV supply dealer. Here are a few travel tips to begin with.

1. Always check for sufficient clearance. Remember the height and width of your unit.
2. Always fill the fresh water tank at an approved potable water filling facility or a known purified drinking water source. Taste the water before filling the water tank in an unfamiliar location. The water in some areas may contain an undesirable taste. Do not use a new hose to fill the water tank. It can leave a distinct rubber or vinyl taste.
3. Showers can take a lot of water. Conserve water by taking a "Sea Shower". This is done by wetting down, turning off the water, soaping thoroughly and then rinsing.
4. Dump sewage only at approved dumping stations.
5. Store liquids in plastic containers with tight fitting caps to prevent spills.
6. Keep an eye on the water and holding tank levels. It is a good idea to dump the holding tank at least every two days.
7. When traveling with children, it is helpful to plan their wardrobe for a week. Place each days clothing in a plastic bag and label the bag with the child's name and day of the week for use.
8. Use sleeping bags whenever possible. They save laundry and take up less storage space than bedding.
9. Make sure all compartment doors have been closed and the door step has been stowed in the correct position before moving the vehicle.
10. Before traveling, make sure the refrigerator door has been secured. Use care when opening the refrigerator door after the vehicle has been stopped. Any articles that have shifted may fall out when the door is opened.
11. During peak tourist season and holidays, it is best to phone ahead and make reservations at the park or campground where you plan to stop.
12. Some states or cities will not permit vehicles with LP gas tanks to pass through highway tunnels. If your route includes a tunnel, check with the highway patrol or department of highways to avoid inconvenience.
13. Do not leave food or odor-causing material in your vehicle for extensive periods of time. Always allow damp clothing, swimwear, hunting gear, etc., to dry before stowing.
14. Become familiar with the fire extinguisher and make sure it is always fully charged. Remove and replace it and read instructions so you know the correct operating procedure before an emergency happens.
15. Make a list of all groceries, fresh meats, vegetables, newspapers, etc., that you may need and try to pick them up during your last fuel stop of the day. This will prevent leaving a good parking spot once you have arrived at



your destination.

16. When driving a motor home, you may have a tendency to crowd the middle of the road. Check the side view mirror frequently to observe how close you are driving to the center line.



**SEVERE  
WEATHER  
INFORMATION**

One of the more serious conditions affecting the motor home traveler and camper is that of the weather. Whether you travel the high mountain terrain, the lower deserts and flatland or the plains of the midwest, the weather is always with you and subject to change, sometimes with little or no warning. However, adequate warnings are normally broadcast over local radio and TV stations.

Motor home travelers and campers often seek secluded areas for weekend recreation or extended summer vacations. Many recreational areas are vulnerable to severe weather situations, especially flash flooding conditions. A few simple precautions may help lessen the hazards of flash flooding or reduce your immediate involvement.

*NOTE: We recommend that all motor home occupants become familiar with these safety precautions, and be constantly alert to changes in weather.*

- Be alert, keep an eye to the sky because thunderstorms can form at any time, in any month of the year. Thunderstorms can produce large amounts of rain over a small area in a short time, which may result in a flash flood. Listen frequently to weather reports on the radio for weather and flood conditions.
- When camping near a stream, leave plenty of sloping bank between you and the stream.
- Avoid deep canyons and dry washes during stormy or threatening weather. Be aware of alternate exits.
- If heavy rain occurs, move to high ground immediately (at least 30-40 feet above the canyon floor or bottom of dry wash).

- During a flash flood, if you cannot move your vehicle, abandon it. Do not attempt to return to your vehicle before the water has receded.
- Do not attempt to wade to your vehicle if the water is above your knees - fast moving water exerts an enormous amount of pressure, making it impossible to remain standing or walking.
- Do not try to drive through flooded areas.
- Follow instructions of local authorities. Leave immediately when advised to do so. Many lives have been lost because people did not heed warnings.
- Have on hand survival supplies for several days, including food, water, first aid equipment and necessary medications. In desert areas during hot weather allow 3-4 gallons of drinking water per person, per day.
- Before you leave home, inform someone of your destination and when you expect to return. Authorities at your destination should be notified immediately if you do not arrive on time.

**REMEMBER THESE TERMS:**

**WATCH:** Severe weather may develop in the specified area. Be alert and prepare for possibility of an emergency.

**WARNING:** Severe weather is occurring or is imminent in certain areas. Move to a safe location immediately.

We highly recommend that the motor home operator obtain a weather radio. These radios offer up-to-date weather condition broadcasts. During good weather, the latest information and forecasts are tape-recorded by local National Weather Service offices in messages that last from three to five minutes. These messages are replayed continually 24 hours a day. The recorded messages are revised every three to four hours, or more frequently when appropriate.

When severe weather threatens, forecasters at the local National Weather Service office inter-

rupt the broadcasts with storm warnings, either recorded or “live” as the situation demands.

The frequencies used for NOAA Weather Radio (National Oceanic and Atmospheric Administration) nationwide are 162.40, 162.475 or 162.55 megahertz.



### NIGHTTIME DRIVING

- Make sure all running lights and signal lights are clean and in working order. Have your headlights periodically checked and adjusted.
- Use care when passing other vehicles. Automobile drivers can easily tell when they are clear of a vehicle they are passing. However, drivers of long vehicles, such as your motor home, may have a more difficult time making that judgement. If possible, have another person in the coach help you watch while passing another vehicle and when in heavy traffic.



### MOUNTAIN DRIVING

Special techniques must be used when driving in mountainous or hilly country. See the “Vehicle Operation” section in your Volkswagen chassis owner’s manual for specific instructions and information.

#### CAUTION

Observe the engine temperature gauge more frequently than normal. If overheating occurs, pull off to the side of the road and allow the engine to thoroughly cool before refilling the radiator and restarting the engine.

### CAMPSITE SET-UP

Try to pick as level a spot as possible on which

to park your motor home.

Leveling the motor home is very important, not only for your comfort, but for plumbing and appliances as well. Some refrigerators are extremely sensitive to being off level. The ammonia vapor cooling system used in most RV refrigerators can “lock up” and permanently damage the refrigerator if it is not level. This is both inconvenient and costly. Also, water and holding tank level indicators may give false readings because water level is greater at one side of the tank than the other.

### Blocking

A motor home can be leveled using several methods, including sophisticated electronic-hydraulic systems. The most common and inexpensive method, however, is “blocking.”

This is done by stacking various lengths of planking (blocks) into a ramp-like formation in a low spot to drive the wheel onto, thus leveling the coach as shown.

Wedge a pair of wheel chocks or similar devices in front and back of a tire that is on the ground as shown to keep the coach from rolling forward or backward off the leveling blocks.

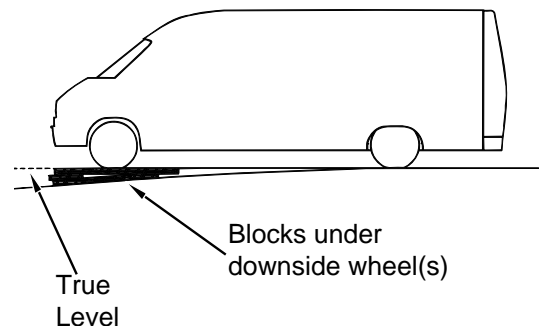

To provide extra firmness, you can place inexpensive mechanical jacks, jack stands or hydraulic “bottle” jacks under the frame to keep the coach from moving on the suspension springs while walking around inside the coach. These devices are not intended to lift the coach; only to hold it rigid and steady.

*NOTE: We do not recommend lifting any of the wheels off the ground for leveling. This*



## SECTION 4 TRAVELING WITH YOUR MOTOR HOME

*Rialta*

*could allow the coach to roll off the jacks, possibly resulting in damage to the vehicle.*

a bath vent while bathing or showering to carry water vapor out of the coach. Avoid making steam from boiling water excessively or letting hot water run. Avoid bringing extra moisture into the coach by way of soaked clothing or snow on shoes. Do not hang-dry wet overcoats or clothing inside the coach.



### EFFECTS OF PROLONGED OCCUPANCY

Your motor home was designed primarily for recreational use and short term occupancy. If you expect to occupy your coach for an extended period, be prepared to deal with condensation and humid conditions that may be encountered.

When you recognize the signs of excessive moisture and condensation in your coach, you should take immediate action to minimize their affects.

*NOTE: Your coach is not designed or intended to be used as permanent housing. Using this product for long term occupancy or permanent housing may lead to premature deterioration of structure, interior finishes, fabrics, carpeting and drapes. Damage or deterioration due to long term occupancy may not be considered normal and, under the terms of the warranty, may constitute misuse, abuse, or neglect, and may therefore reduce your warranty protection.*

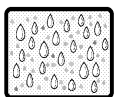

### HUMIDITY AND CONDENSATION

Moisture condensing on the inside of windows is a visible indication that there is too much humidity inside the coach. Excessive moisture can cause water stains or mildew which can damage interior items such as upholstery and cabinets. You can help reduce excessive moisture inside the motor home by taking the following steps:

**Ventilate with outside air:** Partially open one or more windows and a roof vent to circulate outside air through the coach. In cold weather, this ventilation may increase use of the furnace, but it will greatly reduce the condensation inside the coach.

**Minimize moisture released inside the coach:** Run the range hood fan while cooking, and open





(See also Safety Precautions, Section 1 of this manual.)



### LP GAS SUPPLY

The LP gas system supplies fuel for the range, water heater, furnace and refrigerator (while in gas mode). When used and handled properly, this system is safe and economical and provides modern living conveniences wherever you travel.



### SAFE USE OF THE LP GAS SYSTEM

The LP system is designed and built with strict adherence to both federal and recreational vehicle industry requirements for mobile LP gas equipment. For your safety, there are many safety devices and backup systems installed, such as a tank fill overflow valve, an interior LP gas alarm, and an interior carbon monoxide (CO) alarm.

LP gas also contains an odor additive which you can smell if LP is present in the air.

Listed below are a few precautions to observe that will help you to use the LP gas system safely.

- Exercise caution at all times. Be familiar with the distinctive odor of LP gas. If a leak is suspected, turn off the supply valve immediately. Have the LP gas system checked by your dealer or a qualified LP gas service center.
- Do not tamper with the LP gas piping system, pressure regulator or gas appliances. Service and maintenance of LP gas system components should be performed only by your dealer or a qualified LP gas service center.
- Never attempt to connect natural gas to the LP gas system.
- Have the entire LP gas system inspected for possible leaks and missing or damaged parts

at each tank filling. Also inspect before and after each trip, and any time trouble is suspected.

- Turn the LP supply valve off when not using the LP gas system.
- Never use a wrench to tighten the tank supply valve. It is designed to close leak-tight by hand. If a wrench is required to completely close the valve, it is defective and must be replaced.
- Never allow the tank to be filled above the 80 percent level indicated by the flow of liquid gas out of the overflow valve or by the automatic stop-fill device.
- Be sure appliance and outside vents are open and free from obstruction when using the LP gas system.
- Never attach a lock or any device requiring a key to the LP tank compartment door. According to standards set for recreation vehicles, the LP supply valve must be readily accessible in an emergency.
- Exercise caution when drilling holes or attaching objects to the walls. Gas lines and electrical wiring could be seriously damaged and present an extreme safety hazard.

### HOW LP GAS WORKS

LP (Liquified Petroleum) gas is a true gas compressed into liquid form for easy transportation and storage. LP gas is available in two types - propane and butane. It is also called tank gas, bottle gas, or simply LP.

LP is used by appliances in vapor form only, but is stored in the tank as a liquid under very high pressure. As the liquid gas is released, it reverts back to a vapor and expands to many times its compressed volume.



**SECTION 5**  
**LP GAS SYSTEM**

*Rialta*



**SELECTING LP FUEL TYPES**

We recommend using straight propane in your LP tank. Propane gas is commonly available at all LP gas outlets in the U.S. (According to the National LP Gas Association, LP gas outlets in the United States do not offer any other type of liquefied petroleum gas than propane to the general public.) Check local phone directory yellow pages for locations of local LP gas refilling stations or bulk dealerships.

*NOTE: If you travel outside the U.S. with your motor home, you may find butane or propane/butane mixtures available in addition to propane. Because gas-burning RV appliances are designed to run on propane only, we recommend that you request straight propane only. Butane burns about 30 percent hotter than propane and can overheat some appliances, particularly refrigerators, and cause permanent damage. Other appliances designed to operate on propane can become sooted and lose efficiency by using butane fuel.*

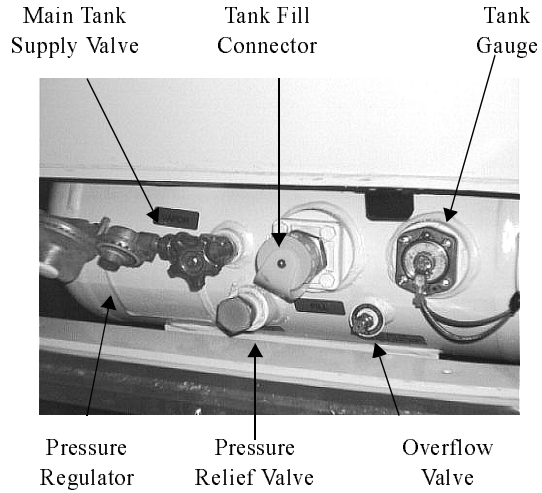

<b>LP Tank Capacity</b>	<b>5.6 gals.*(7 gals. w.c.)</b>
-------------------------	---------------------------------

\*LP Gas tank capacity shown is the usable “full” LP gas capacity, which is 80% of the tank manufacturer’s listed water capacity (w.c. shown in parenthesis). An LP tank must have at least 20% of tank volume free to allow for expansion and proper vaporization of the liquid fuel. The tank is also equipped with mandatory safety shut-off equipment that prevents filling above this level.

**LP TANK SYSTEM**

The storage reservoir for the LP gas system is a horizontally mounted metal tank which is permanently attached to the vehicle frame. The tank is accessible only from the outside of the vehicle. The tank supply valve is located near the top center of the tank, next to the regulator. Before opening the supply valve, check to be sure all controls for gas appliances are in the “Off” or “Pilot Off” position. If this step is not performed, LP gas could accumulate inside the motor home creating a fire or explosion hazard.

**REFILLING LP TANK**

Since the LP tank is permanently mounted to the frame, the motor home must be taken to an LP dealership for filling. Do not attempt to remove the LP tank from the vehicle.

There are many LP gas refueling stations located throughout the country. These stations are listed in the telephone directory Yellow Pages under “Gas - Liquefied Petroleum - Bottled and Bulk.”

The tank is equipped with a fill adapter which allows easy filling with any LP filling equipment. The tank is full when liquid LP gas appears at the overflow valve.

*NOTE: The LP tank is equipped with an automatic 80% stop-fill device.*



## WARNING

DO NOT FILL CONTAINER TO MORE THAN 80 PERCENT OF CAPACITY. Make sure the motor home is level when filling. It is possible to accidentally overfill the tank if the vehicle is unlevel, especially if the fill valve is on the uphill side. Overfilling the LP gas container can result in uncontrolled gas flow which can cause fire or explosion. A properly filled container will contain approximately 80 percent of its volume as liquid LP gas.

**All pilot lights must be extinguished** and supply valve closed before refilling LP gas tanks or vehicle fuel tanks.

**Do not smoke or expose an open flame** while near an LP refueling area. LP gas is heavier-than-air and extremely flammable.

**Never use an open flame** to test for LP gas leaks.

Replace all protective covers and caps on LP system after filling.

**Never** fill the LP tank with engine or generator running.

**Do not** alter or remove LP tank gauge at any time.

## AIR IN THE LP GAS TANK

If your LP gas appliances do not stay lit or require frequent adjustment, even though you know the LP tank contains sufficient fuel, the problem may be air in the LP gas tank. Air in the tank mixes with the LP gas vapors causing them to burn poorly. This condition could linger for weeks if the air is not purged from the tank. Most LP gas dealers have equipment for purging air from LP gas tanks and will purge before refilling the tank.

## TRAVEL WITH LP GAS

It is illegal for vehicles equipped with LP tanks to travel on certain roadways or through certain tunnels in the U.S. To avoid inconvenience, check state regulations concerning flammable gas transportation.

## REGULATOR

The pressure regulator is protected from the elements by a plastic cover which should be left in place at all times. Only your dealer or a qualified LP gas service should remove the regulator cover for adjustments.

## WARNING

Inspect the pressure regulator vent hole periodically for blockage. If any obstruction is apparent, have the regulator serviced by your dealer or a qualified LP gas service center.

LP gas regulators are installed with the diaphragm vent facing downward. Make sure that the regulator vent always faces downward to minimize vent obstruction which could result in excessive pressure, causing a fire or explosion.

Regulator freeze-ups are caused by the presence of moisture in fuel. This moisture will pass through the cylinder valve and into the regulator where it can freeze. Fuel producers, tank and bottle manufacturers and LP gas dealers take every precaution to reduce moisture, but sometimes only a fraction of an ounce entering the tank can cause problems. To help avoid the possibility of freeze-up, always keep tank control valve closed when not in use, even when tank is empty, to prevent moisture from collecting on the inside.

If regulator freeze-up should occur, you may attempt to thaw the regulator using a light bulb. **DO NOT USE AN OPEN FLAME OR HEAT LAMP.**

If moisture begins to cause problems, have your LP gas dealer inject a small amount of dry



**SECTION 5**  
**LP GAS SYSTEM**

*Rialta*

methyl alcohol in your tank (approximately one ounce to 20 pounds or one pint to 100 gallons) to help guard against regulator freeze-ups.

In very cold weather when a large volume of gas is being used for heating, it is possible to experience a loss of gas pressure. At first, this problem may appear to be caused by a regulator freeze-up, but is actually caused by failure of the liquid gas to vaporize as fast as it is needed. As the temperature becomes colder, it is increasingly harder for the liquid LP gas to “boil-off” into a vapor. At the same time, the demand for LP to produce heat increases to the point where the system cannot maintain production.

The only actual solution to this problem is to reduce the consumption of gas where possible. Adjusting the temperature on the gas/electric refrigerator may be a first step. Using less hot water will help as well.

The colder the temperature, the slower LP will vaporize. Also, the less liquid in the tank, the slower it will vaporize. So a nearly empty tank in freezing temperatures can create a problem. Propane will convert to a usable gas at temperatures down to -44°F, so it is a common heating fuel in cold climates. However, even propane vaporizes slower as the temperature becomes colder.

The greater the amount of liquid gas in the tank (up to the 80% level) the greater the amount of LP gas vapor generated. The following is an example of the number of BTU’s available from an 84-pound tank at 0° F at three levels. As you can see, the number of BTU’s decreases as the tank is emptied. Nearly twice as many BTU’s are available from a full tank than one that is one-fourth full.

**BTU’s Available at 0° F.**

<u>Tank Level</u>	<u>BTU’s</u>
80%	64,000
50%	50,400
20%	33,000

The following LP Gas Vaporization and Temperature Relationship chart typifies the LP gas loss with a decrease in temperature. The percentage figures are the increase or decrease of vapor that would be available at 0°F. These figures apply to any size LP gas tanks.

<u>Temperature</u>	<u>Percentage of BTU’s Available at 0° F.</u>
20° F.	200%
10° F.	150%
0° F.	100%
-5° F.	75%
-10° F.	50%
-15° F.	25%
-20° F.	12 1/2%
-44° F.	Propane will not vaporize



**LP GAS LEAKS**

The following label has been placed in the vehicle near the range area. If you smell gas within the vehicle, quickly and carefully perform the procedures listed.

<b>IF YOU SMELL GAS</b>
1. Extinguish any open flames, pilot lights and all smoking materials.
2. Do not touch electrical switches.
3. Shut off the gas supply at the tank valve(s) or gas supply connection.
4. Open doors and other ventilating openings.
5. Leave the area until odor clears.
6. Have the gas system checked and leakage source corrected before using again.

**LP GAS ALARM** - See page 1-2.



**WINTER USE OF LP GAS**

Because of the vaporization characteristics of LP gas, it is important for the winter camper to know how to use the LP system most efficiently.



## WARNING

Make sure the filling attendant uses the 80% overflow valve when filling the tank. A tank should never be filled above the 80% level to allow for vaporization and liquid expansion.

Do not place LP gas containers inside the vehicle. LP gas containers are equipped with safety devices which relieve excessive pressure by discharging gas to the atmosphere.

Do not place LP gas containers, gasoline, or other flammable liquids inside the vehicle. Fire or explosion may result.

Each gallon of liquid LP gas contains approximately 92,000 BTU's of heat energy; or putting it another way, each gallon of LP gas produces approximately 36.2 cubic feet of dry gas for cooking, heating, water heating and refrigeration.

To find out how long a gallon of LP gas will last, you should determine the total BTU input on all your LP gas appliances in use. Let's say you have a heater that has a 10,000 BTU input per hour of operation. A gallon of LP gas would last 9.2 hours of continuous operation (92,000 divided by 10,000 = 9.2). To estimate how long a gallon of LP gas lasts, try to determine what your total daily BTU input is, then divide into 92,000 to arrive at an approximate daily LP gas consumption.



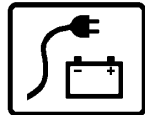

(See also Safety Precautions, Section 1 of this manual.)

Your motor home is equipped with an electrical system consisting of two separate voltages; a 12-volt DC system and a 110-volt AC system. The 12-volt system consists of two internal power sources, while the 110-volt system is operated from an outside power source or the optional 110-volt generator. Both systems operate through a single load center to provide electrical power to the motor home.

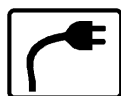

### 110-VOLT AC SYSTEM

The 110-volt system operates from an outside 110-volt utility service such as those at campgrounds, or from the optional 110-volt generator. When the power cord is connected to an outside power source, or when the generator is in operation, the power converter automatically changes a portion of the 110-volt current to 12-volt DC current. All equipment in the motor home that is normally powered by the auxiliary battery is then powered through the converter.

In addition, the following equipment is entirely dependent on the 110-volt current: roof air conditioner, refrigerator (when placed in AC mode), microwave oven and any 110-volt electrical equipment used at convenience outlets.



### EXTERNAL POWER CORD (Shoreline)

The external utility power cord (commonly referred to as a “shoreline”) is stored in the trunk compartment on the rear of the motor home.

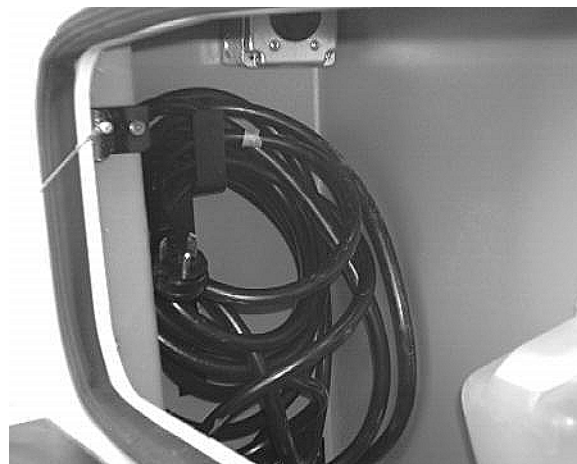

Shoreline Cord

An access hatch in the bottom of the trunk compartment lets you route the shoreline cord out the bottom of the compartment so you can close the trunk door while the shoreline is connected.

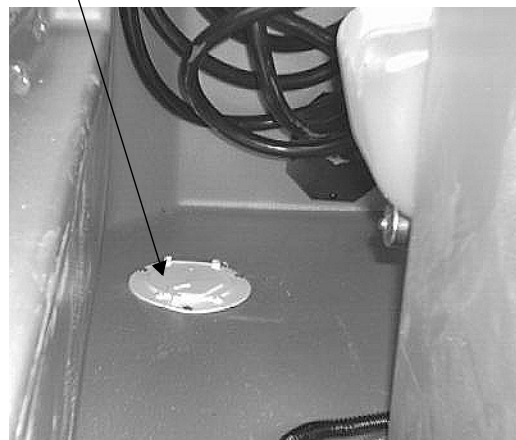



**WARNING**

**Do not** connect the external power cord to any receptacle until you have contacted the owner and/or attendant of the premises to verify proper polarity and grounding.

It is the responsibility of the owner of the electrical receptacle to ensure that the receptacle is properly wired and grounded.

Reverse polarity and improper grounding of the vehicle can cause personal injury or death

To connect to an external power source, route the cord out of the storage compartment and plug it into a suitable power receptacle.

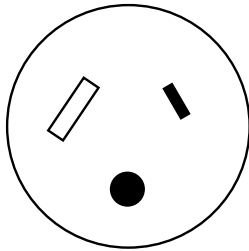

The three-prong power cord is designed to ground the electrical system through the receptacle. It is also designed to carry the amperage output of most campground outlets. If the electrical receptacle to be used is designed to mate with the three prongs on the power cord plug, the electrical connection can be expected to carry rated load.

**WARNING**

**Do not** plug the power cord into an outlet which is not grounded, or adapt the plug to connect to a receptacle for which it is not designed.

Be sure that all three prongs of the supply cord are properly plugged into the receptacle.

**Do not** connect the power cord to an extension cord.

**Do not** plug the power cord into the generator receptacle while the generator is running

Most campgrounds are equipped with a fuse or circuit breaker at the receptacle. This protects the park's wiring, as well as the power cord on your vehicle, from electrical damage. If electrical power fails, contact the park attendants and have them check the fuse or breaker for your supply receptacle.

When disconnecting the power cord, neatly replace it in the storage compartment.

**POWER LOAD CENTER**

The load center is located on the end of the vanity cabinet just inside the entry door on model 22FD. On models 22QD and 22HD, it is located on the front of the left dinette seat base.

The load center panel contains the coach 110-volt circuit breakers and 12-volt fuses.

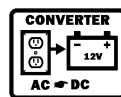

**POWER CONVERTER**

The power converter changes 110-volt AC current from the auxiliary generator or the shore-line into 12-volt DC current for use by 12-volt equipment in the motor home.

Certain circuits, however, remain unchanged for use by items which require 110-volt current, such as the air conditioner, microwave and the refrigerator in AC mode.





## WARNING

Do not store anything around or on top of the converter, or in front of the cover. The converter generates heat while operating, and needs unrestricted air flow for proper cooling.

### Charging Section

The converter charges the coach battery while 110-volt external power is connected. The converter will automatically “sense” the condition of the coach battery. If it is below “full charge”, the Charging Section will start charging the battery.

If the coach battery has been extremely discharged, it will accept charge at a relatively high amperage rate. If battery is only slightly discharged, it will charge at a lower amperage rate. The rate of charge will decrease as the battery reaches “full charge”, then will remain “trickle” charging at a very low amperage rate. If your storage battery does not charge as described above, it is possible the battery is defective.

*NOTE: We do not recommend leaving the shoreline plugged in continuously during storage periods because the batteries can lose electrolytic fluids and become damaged from continuous charging without periodic use. We recommend following regular battery inspection and maintenance, especially in cold weather. See “Battery Maintenance” on page 6-7 this section.*

### Thermal Overload Protector

A thermal overload protector will shut-down the converter if it becomes overheated. This can result from operating above its maximum limit for an extended period of time or by obstruction of ventilation to unit.

*NOTE: 12-volt lights and motors will automatically draw from battery power in this event.*

The thermal overload protector will reset itself after a cool-down period, and the lights and motors will again resume operation from the converter. If the overload trips again shortly after

reset, take immediate steps to correct cause of overheating. A portion of RV 12-volt load (lights or motors or both) should be turned off to reduce total load. Also, inspect power converter section to make certain ventilation is not blocked.

*NOTE: The converter will not change 12-volt DC current to 110-volt AC.*

### 110-Volt Circuit Breakers

The breaker panel protects all 110-volt components in the motor home from either an overload on the circuit or a short in the wiring or component itself. When an overload or short develops, the breaker will open preventing any further flow of electricity and, therefore, damage to the system.

Shut off the equipment (example: roof air conditioner) and allow a brief cooling period. Then reset the breaker by moving the switch to “Off” and back to “On”. If the breaker is continually tripped and no overload is evident, have the system checked for a short in the wiring or the appliances.

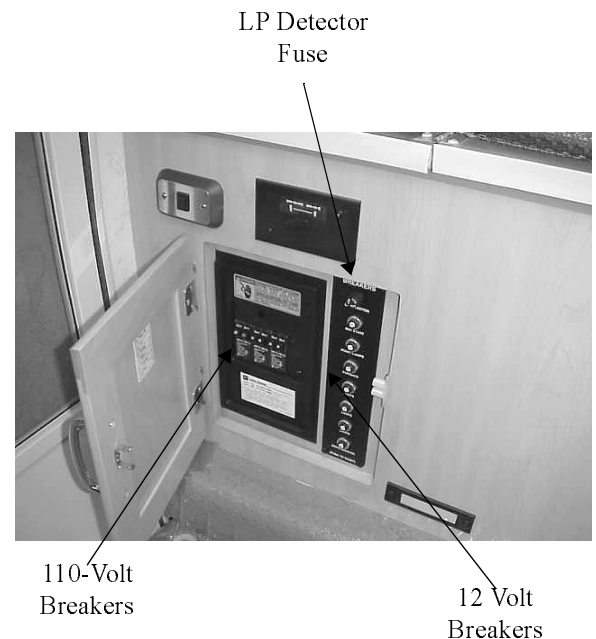

Power Load Center - Model 22FD  
(On end of vanity cabinet)

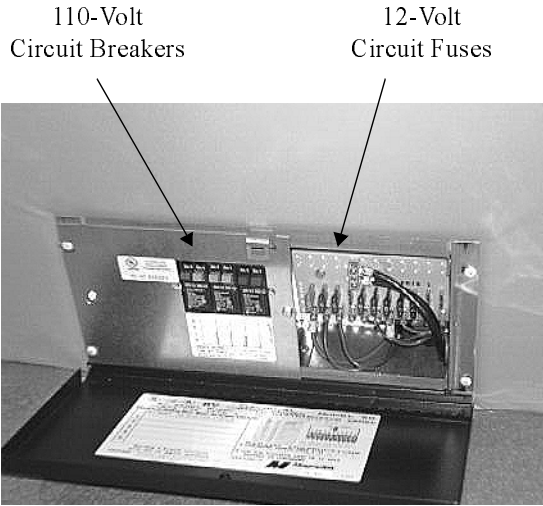

Power Load Center - Model 22QD & 22HD

**110-Volt Receptacles (Outlets)**

A standard AC electrical outlet is provided on the rear side of the galley cabinet for connecting small appliances such as televisions, radios, toasters, etc. An exterior outlet is also located on the outside of the coach near the entrance door.

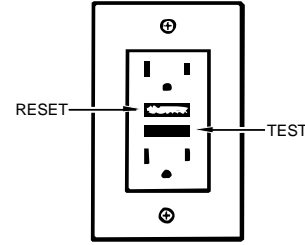

In model 22FD, the GFCI unit is located on the end of the vanity cabinet just inside the entry door.

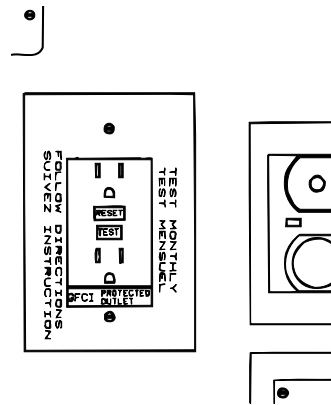

GFCI - Model 22FD



**GROUND FAULT CIRCUIT INTERRUPTER**

Exterior, bath and galley outlets are connected to a GFCI (Ground Fault Circuit Interrupter), which is an extremely sensitive circuit breaker that will help to protect against severe electrical shock if a ground fault develops. If such a condition occurs, the GFCI will break the circuit by turning off the power to the protected outlet. Should this occur, unplug all the appliances on that circuit and press the reset button on the GFCI equipped outlet.

If the GFCI keeps tripping, have the electrical system checked and repaired if necessary before using again.

The GFCI outlet is located on the rear side of the wardrobe cabinet in model 22QD & 22HD vehicles.

**WARNING**

The GFCI will not completely eliminate electrical shock. Small children and persons with heart conditions or other disabilities which make them especially sensitive to electrical shock may still be injured by a 110-volt receptacles even though protected by a Ground Fault interrupter.

*NOTE: In compliance with CSA electrical codes, the appliance outlet in Canadian equipped coaches is not connected to a GFCI protected circuit.*

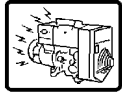

## AUXILIARY 110-VOLT GENERATOR Optional

The auxiliary generator allows you to use 110-volt appliances and devices when a utility hook-up is not available. The generator may be operated while the vehicle is parked or while in motion, and can run continuously if necessary.

### WARNING

**Careless handling** of the generator and electrical components can be fatal.

**Never** touch electrical leads or appliances when your hand are wet, or when standing in water or on wet ground.

**Do not** attempt to repair the generator yourself. Service should be performed by an authorized service center.

**Do not** plug the power cord into the generator receptacle while the generator is running.

To use the 110-volt generator, plug the power cord into the generator receptacle within the shoreline compartment.

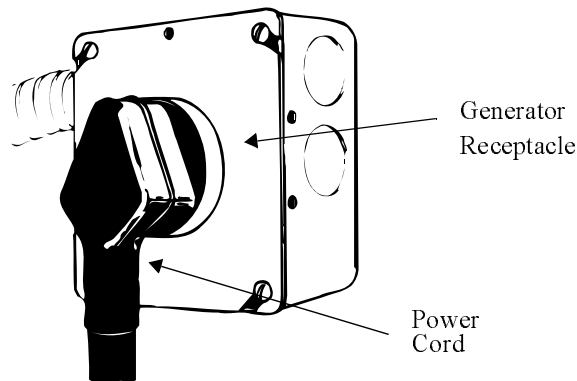

### Starting and Stopping the Generator

The generator switch is located on the system monitor panel in the dinette area. The generator starter circuit does not rely on the automotive battery, so the switch will operate whether the ignition switch is on or off.

Consult the generator manufacturer's owner's manual in your Owner InfoCase for complete instructions on starting and stopping the generator.

### Basic Generator Operation:

#### Starting:

- See the generator manufacturer's operating guide in your Owner InfoCase for specific instructions.
- Reduce all electrical loads. (Shut off lights, fans, appliances, etc.)
- If the generator has not been run for two weeks or more, you may need to prime the fuel system before attempting to start. See the generator manufacturer's operating guide in your Owner InfoCase for procedure.
- Press the generator starter switch on and hold until generator engine is running, then release.
- Let the engine to stabilize and run smoothly before turning on appliances or electrical equipment.
- Do not overload generator by turning on too many items. Overloading will cause the circuit breaker on the generator to trip. If this happens, the generator will run but no electricity will be present in the coach. You must then reset the circuit breaker on the side of the generator. Refer to the output specifications of your generator in the generator manufacturer's manual. Then see the following electrical load chart to estimate your typical loads.
- Before shutting generator down, turn off electrical loads and let engine run at no-load for a few minutes to cool down whenever possible.
- Press the generator switch Off and hold until the generator engine comes to a complete stop.



Approximate Power Requirements of Common Appliances	
Appliance or Tool	Approximate Power Consumption (Watts/Amps)
Vacuum cleaner	200-500W/1.7-4.3A
Coffee Maker	550-700W/4.8-6.1A
Hair dryer	800-1500W/7.0-13.0A
Electric clothes iron	500-1200W/4.3-10.4A
Electric blanket	50-200W/0.4-1.7A
Television	80-100W/0.7A
Electric drill	250-750W/2.2-6.5A
Air conditioner	1400-2000W/13-19A
Power converter	300-500W/2.6-4.3A
Microwave Oven	700-1500W/6.0-13.0A

### Operation Warnings and Cautions

#### **WARNING**

The exhaust of all internal combustion engines contains carbon monoxide (CO). This gas is colorless, odorless, tasteless, and lighter than air and poisonous. The exhaust systems of both your motor home engine and your generator engine have been installed with your safety in mind. However, certain precautions must be taken when using them to protect you from conditions beyond the control of the manufacturer.

1. **Do not** simultaneously operate the generator engine and a ventilator which could draw air into the vehicle, resulting in the entry of exhaust gases.
2. **Do not** open windows or ventilators on the end or side of the vehicle where exhaust of the generator is located.
3. **Park the vehicle** so that the wind will carry the exhaust away from the vehicle. Also, note the position of other vehicles to be sure their exhaust will not enter your vehicle.
4. **Do not** operate the generator engine when parked if vegetation, snow, buildings, vehicles, or any other object can deflect the exhaust under or into the vehicle.

### Further Information

Refer to the generator manufacturer's owner manual for information on oil level checking and maintenance of your generator. The manual is included in your Owner InfoCase.

Check auxiliary generator oil level frequently during periods of use. Refer to the generator manufacturer's information in your Owner InfoCase for specific recommendations.

#### **WARNING**

Never check generator oil level while generator engine is running.



### 12-VOLT DC SYSTEM

The DC voltage system consists of the automotive battery and the 12-volt motor home auxiliary battery.

#### **AUTOMOTIVE (STARTING) BATTERY**

The automotive battery is used solely to operate the engine starter and all automotive accessories and controls found on the instrument panel. This includes the horn, speed control, all exterior lights, radio, windshield wipers, rear auto heater fan, etc.

#### **COACH BATTERIES**

The coach battery is a "deep-cycle" type battery specially designed for recreational vehicle use. It will provide longer lasting power than a standard automotive battery, and it will withstand the frequent drain-and-recharge cycles that occur under the demanding conditions of a camping outing.

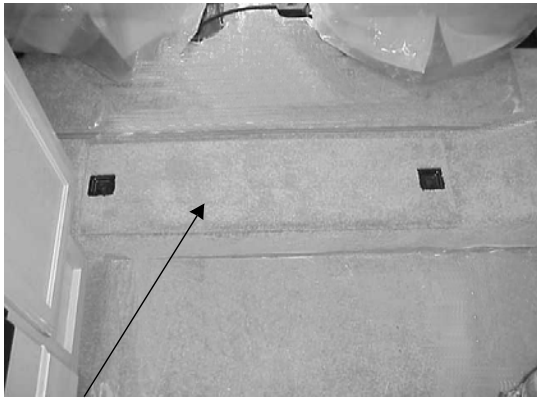

House Battery Compartment  
on floor behind front seats

The coach battery supplies current to 12-volt equipment located in the living area of the motor home. This includes: interior lights, refrigerator, furnace fan, water pump, water level and holding tank gauges, and 110-volt generator starter.

The coach battery is automatically charged by the engine alternator while the engine is running.

## 12-VOLT FUSES AND CIRCUIT BREAKERS

All 12-volt circuits and equipment in the coach area of the motor home are protected by a fuse or circuit breaker panel. When a circuit is overloaded or a short develops in any part of the system, a fuse or breaker will shut down that circuit. If this happens, turn off all affected lights or appliances and reset the breaker or replace the fuse with a new one of equal amperage rating.

### Modified Reset Circuit Breaker

A modified reset breaker is located in the battery compartment. This type of breaker cannot be manually reset. It must have the electrical current disconnected in order to reset itself. This means turning off or unplugging all electrical devices then disconnecting the coach battery cable for a few seconds until the breaker resets. If the breaker keeps tripping, an electrical malfunction exists somewhere in the coach and requires service from your dealer.

### FUSE PANEL

The fuse panel is mounted on the right-hand side of the load center.

A label on the panel states the amperage rating and circuit protected for each fuse.

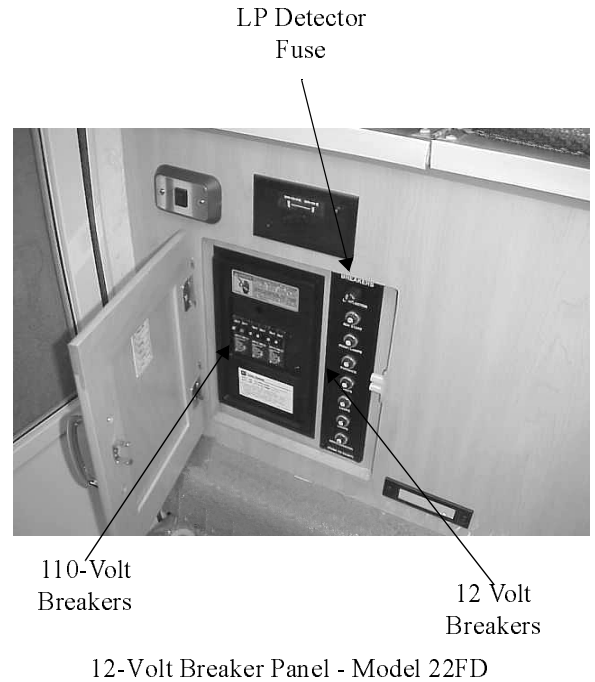

110-Volt  
Breakers

12 Volt  
Breakers

12-Volt Breaker Panel - Model 22FD

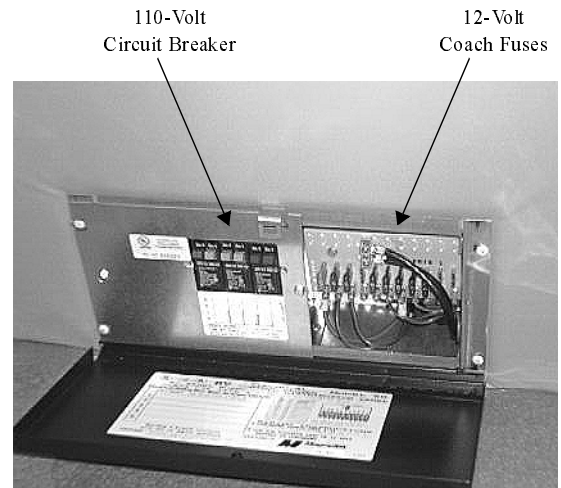

110-Volt  
Circuit Breaker

12-Volt  
Coach Fuses

12-Volt Fuse Panel - Model 22QD & 22HD

The fuse panel accepts only blade type plug-in fuses. Always replace fuses with those of the same amperage rating.

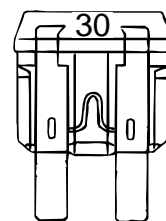

Good Fuse

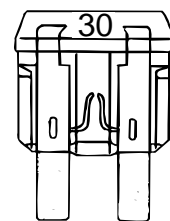

Bad Fuse



### Further Information

Refer to the converter manufacturer's information provided in your Owner InfoCase for additional information about your power converter system.

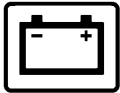

## BATTERY INFORMATION

### AUTOMOTIVE BATTERY ACCESS

The automotive (starting) battery is located in the engine compartment.

### COACH BATTERY ACCESS

The coach battery is located in an interior battery storage compartment for convenient access for periodic inspection or maintenance. The compartment is located in the floor of the cab, in the aisle area behind the front seats.



## BATTERY STORAGE AND MAINTENANCE

Lead -acid type batteries are electro-chemical devices for storing and releasing electrical charge. As such, they are simply an electrical reservoir, not an electrical source. As soon as energy is removed from the battery, it should be replaced by the engine alternator or the RV converter system.

**If a battery sits unused for 30 days or more,** especially during warm weather, it can develop a deposit of sulfate crystals on the metal plates in-

side the battery. This condition is called sulfation or sulfating, and prevents the battery from either releasing or accepting a charge. If this condition occurs, the battery must be replaced.

**If a battery does not contain at least 80% charge** during freezing temperatures, the electrolyte can freeze and crack the battery case.

**The two best defenses** against sulfating or insufficient charge are to:

1. disconnect the batteries by removing the ground (-) cable to avoid *parasitic discharge* (the trickle discharge caused by directly connected components like LP gas detectors or digital clock displays, etc.), and
2. check the battery and recharge as necessary at least once a month during long storage periods.

Further precautions are:

- Remove the battery from the coach.
- Store it in a cool place on a wooden or rubber pad to inhibit conductive transfer.
- Check the state of charge periodically to avoid discharge or sulfating.

### Battery Maintenance

To ensure that the battery will always accept and hold a charge, some minor maintenance practices should be followed:

- Make sure the battery always remains securely clamped in the battery tray and the cable clamps are tight on the terminal posts and free of corrosion.
- Remove and neutralize any corrosion buildup on the battery by brushing with a solution of baking soda and water, and then rinsing with clear water. The water will drain through the bottom of the compartment. Rinse the inside of the battery box with clean water also after rinsing the battery.

*NOTE: Make sure vent caps are on securely to prevent baking soda solution from entering the battery and contaminating the electrolyte fluid.*



## WARNING

Before removing any battery cables or battery, make sure all 12-volt equipment in the motor home is off and the power cord has been disconnected.

Always remove jewelry and wear protective clothing and eye covering when checking or handling batteries.

- Clean and tighten battery terminals and have the specific gravity checked at least once a year.
- Every two months or more often in hot weather, check the battery fluid level. Fill to approximately 3/8 inch above the plates. **DO NOT OVERFILL.**
- If fluid is added during freezing weather, the motor home should be driven several miles to mix water and electrolyte to prevent freezing.
- Fluid level check may be omitted if equipped with maintenance-free batteries.

## WARNING

To prevent wiring damage, it is essential when replacing the cables on the battery, or when using a “booster” battery, that the positive post and the positive cable be attached and the negative post and negative cable be attached. The posts are marked (+) plus and (-) minus. If a “fast charger” is used while battery is in the motor home, disconnect both battery cables before connecting the charger. Never attempt to charge or boost a frozen battery.

*NOTE: We do not recommend leaving the shore-line plugged in continuously during storage periods because the batteries can lose electrolytic fluids and become damaged from continuous charging without periodic use.*

*We recommend following regular battery inspection and maintenance, especially in cold weather.*

## BATTERY CONDITION METER

This meter allows you to check the level of charge in the coach battery in your motor home. It is located on the monitor panel on the wall in the left dinette seat area. (See Section 8.)

To obtain an accurate reading:

1. Both the automotive engine and the auxiliary generator engine must be stopped.
2. An interior light should be turned on to provide a small load which draws off battery surface charge.

## TRAILER WIRING CONNECTOR

Your coach is pre-wired for trailer or car towing lights with a 6-pin socket on the rear bumper. The connector plug is supplied in the coach parts package provided to you by your dealer when you took delivery of the vehicle.

The diagram shows proper connection of trailer or tow vehicle wiring to the coach light system. Remove the small screw near the end of the plug and slide the contact assembly out of the barrel.

TM = Tail lights  
GD = Ground  
LT = Left Turn  
RT = Right Turn  
S = Brake lights  
A = Backup lights

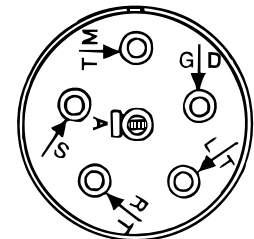







### FRESH WATER SYSTEM

The fresh water system provides water to the galley sink, shower, bathroom lavatory, toilet and water heater. Water may be supplied by either of two sources:

- a water tank located within the motor home, or
- any external water source to which the motor home may be connected, known as “city water”.

### FILLING FRESH WATER TANK

Always fill the fresh water tank at an approved potable water filling facility or a known purified drinking water source.

The tank may be filled by inserting a hose into the tank fill opening. A built-in vent prevents the tank from becoming air-locked while filling.

When neither city water nor a hydrant are available, a bucket and funnel may be used to fill the tank, but this can take a considerable amount of time.



**Fresh Water Tank Capacity: 16 gal.**



### WATER PUMP

Pressure for the water system is supplied by a water system demand pump which is fully automatic after initial priming. When a faucet is

opened, the pump begins operation to provide a constant flow from the tank. When the faucet is closed, the pump automatically shuts off.

### Water Pump Location - Model 22QD & HD

The water pump is located beneath the right (passenger side) rear dinette seat. It can be accessed either by lifting the seat cushion up or by removing the face panel from the dinette seat base.



The panel is held in place against the seat frame tubes by strips of hook-and-loop tape.

### Water Pump Location - Model 22FD

The water pump is located below an access hole beneath the bedboard or the rear bed in the left (driver side) rear of the coach. Lift or remove the bed mattress to expose the access hole.





## WATER PUMP SWITCH

The water pump switch is located on the monitor panel (See Section 8). While the switch is in the “ON” position, the pump will automatically supply water pressure as it is needed. It is recommended that the pump switch be turned off whenever you are away from the vehicle or not using the water system. A slow leak in a faucet could drain the water system and discharge the coach battery.

*NOTE: The water pump does not need to be switched on while the coach is connected to a city water hookup. See “External Water Supply” on the following page.*

## INITIAL START-UP

1. Make sure that all water drain valves are closed, including water heater valve. (Refer to Section 10.)
2. Turn water pump switch to “OFF” position. Fill water tank.
3. Open all faucets, hot and cold.
4. Turn on pump switch.
5. Close each faucet as it begins to deliver a steady stream of water (close cold water first). Leave hot water faucets on until they also deliver a steady stream of water. This will ensure that the water heater is filled with water.
6. Check to be sure pump stops soon after all faucets have been closed.
7. Pump is now ready for automatic operation. Pump will start when a faucet is opened and stop when the faucet is closed.

## DISINFECTING FRESH WATER SYSTEMS ON RECREATION VEHICLES

**(As approved by the U.S. Public Health Service)**

To assure complete disinfection of your fresh water system, it is recommended that the following procedure be followed on a new system, one that has not been used for a period of time, or one that may have become contaminated. This procedure is also recommended before long periods of storage such as over winter.

1. Prepare a chlorine solution using 1 gallon of water and 1/4 cup of household bleach (sodium hypochlorite solution). With tank empty, pour chlorine solution into the tank. Use 1 gallon solution for each 15 gallons of tank capacity. This procedure will result in a residual chlorine concentration of 50 ppm in the water system. If a 100 ppm concentration is required as discussed in item 3, use 1/2 cup of household bleach with 1 gallon of water to prepare the chlorine solution. One gallon of the solution should be used for each 15 gallons of tank capacity.
2. Complete filling of tank with fresh water. Open each faucet and run the water until a distinct odor of chlorine can be detected in the water discharged. Do not forget the hot water taps.
3. Allow the system to stand at least 4 hours when disinfecting with 50 ppm residual chlorine. If a shorter time period is desired, then a 100 ppm chlorine concentration should be permitted to stand in the system for at least 1 hour.
4. Drain and flush with fresh water.

### WARNING

Chlorine is poisonous - recap bottle and clean utensils after use.

Never use automotive type antifreeze in your potable water system as it is poisonous.



## EXTERNAL WATER SUPPLY (“City Water”)

### To connect to an external source:

1. Turn the demand pump switch to OFF.
2. Attach a hose from the external water source to the city water connection on the left side of your vehicle.
3. Turn on the external water source.

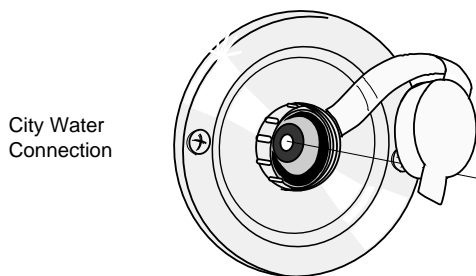

When connected to an outside source of water, the water bypasses the demand pump and storage tank and supplies pressure directly to individual faucets and toilet. A check valve built into the pump prevents water from entering the pump and filling the storage tank.

*NOTE: Because city water pressure varies from location to location, we recommend using an in-line water pressure regulator to prevent damage to any components, connections and seals in your fresh water system. We recommend a regulator that controls water pressure to 40 psi maximum.*

*A water pressure regulator may be obtained from any well stocked RV dealership retail center and some retail discount centers. These devices simply connect in-line between the supply hose and the city water input on the coach.*

### To disconnect from the external source:

1. Turn the external source off.
2. Open a faucet inside the vehicle to relieve line pressure.

3. Disconnect the hose from the vehicle and replace the cap on the connection.

## WATER DRAIN VALVES

The water drain valves are used to drain water from the water tank and the water supply lines when preparing the motor home for storage or when sanitizing the water system. The water line drain valves have teardrop shaped white handles. The fresh water tank drain has a large yellow handle. To drain the tank, move the handle so that it is parallel to the drain pipe.

**Model 22HD/22QD:** The drain valves are located beneath the right rear dinette seat. They can be accessed either by lifting the seat cushion up or by removing the face panel from the dinette seat base. The panel is held in place by tube clips or hook-and-loop fasteners. Pull outward gently and evenly to remove. Replace by pressing panel gently back into position.



Water Tank Drain Valve

**Model 22FD:** The drain valves are located below an access hole beneath the bedboard of the rear bed in the left (driver side) rear of the coach. Lift or remove the bed mattress to expose the access hole.



To open or close the water line drain valves, turn the handles in the directions indicated by the following illustration.

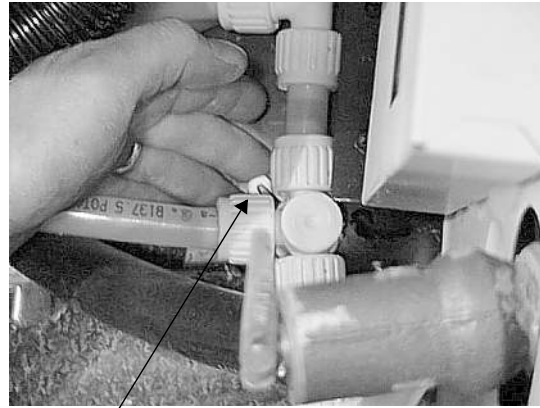
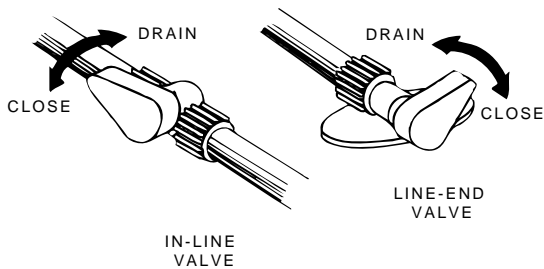

Bypass Valve is on the bottom side of the water lines near the water heater. Note that the connection resembles a “T”. The valve must point toward the ‘foot’ of the “T” to be in bypass mode.

## WASTE DRAINAGE SYSTEM

The drainage system is self-contained and uses two separate holding tanks to contain the water until it can be dumped at an appropriate waste water disposal site. This means you can use the toilet, sinks and shower even in areas where utility hookups are not available.

The main holding tank contains the sewage from the toilet, and waste water from the bathroom lavatory and shower. It is commonly called the black water tank. The second holding tank contains the waste water from the galley sink, and is commonly called the gray water tank.

### Water Heater Bypass Valve

The water heater bypass valve allows you to bypass the water heater tank when winterizing the water lines using RV water system anti-freeze. The valve is located on the underside of the water lines near the water heater as shown. Note that the valve connection to the water lines resembles a ‘T’. The valve handle must point toward the ‘foot’ of the ‘T’ to bypass the water heater.



## Holding Tanks



The black water tank holds waste water from the toilet, lavatory, and shower.

Black (Sewage) Tank..... 13 gals.



The gray water tank holds waste water drained from the galley sink.

Gray (Waste Water) Tank

Model 22QD ..... 9 gals.

Models 22FD ..... 6 gals.

Model 22HD ..... 7 gals.

## HOLDING TANK LEVEL INDICATORS

You can check the levels of the waste water-holding tanks and the fresh water tank using the monitor panel.

Press the button labeled “Gray Tank” or “Black Tank” to show the level in each tank.

See Section 8 - Appliances for more information on the monitor panel.

## DUMPING HOLDING TANKS

The holding tanks are dumped through a common outlet located on the left side of the vehicle, near the rear wheels. The sewer drain hose is stored in a compartment inside the generator door on the right side toward the rear of the vehicle.

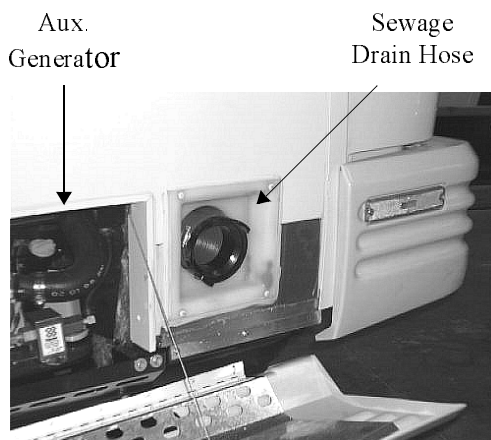

1. Remove drain hose from hose compartment.
2. Remove dust cap from drain and connect drain hose. Be sure it is firmly attached.
3. Place the other end of sewer hose into disposal opening.

4. Open the sewage valve with a quick pull. **OPEN ONE VALVE AT A TIME.** Move hose gently about to dislodge any waste and to ensure complete drainage.

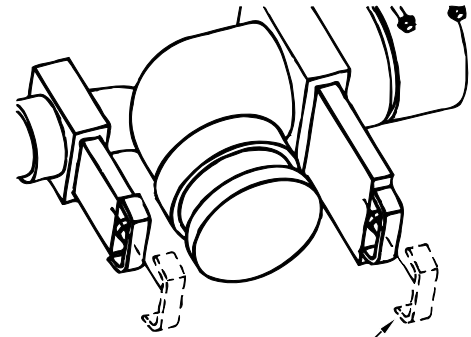

Pull to drain black tank

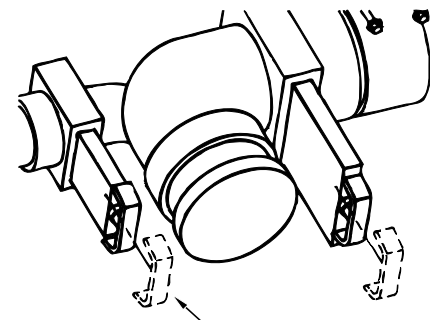

Pull to drain gray tank

5. Close sewage valve and open waste water valve with a quick pull. Make sure there are no sags in the hose during drainage. Close valve handle as soon as tank is empty.
6. After both tanks have been drained, run several gallons of water into the sewage tank through the toilet. Then open sewage dump valve and drain the tank again. Close valve and replace dust cap securely.
7. It is advisable to add an odor control chemical to the sewage holding tank. These chemicals are available at most R.V. stores.
8. Rinse sewer hose thoroughly with water and stow.

*NOTE: We recommend that you dump all holding tanks before traveling to avoid carrying unnecessary weight.*



### USING ON-SITE SEWER HOOK-UPS

The drain hose may remain attached to the dump outlet while the motor home is parked and connected to an on-site sewage hook-up.

When using a sewer hook-up, keep the dump valves closed until a tank becomes full or when preparing to leave the site. This keeps the solids in suspension, allowing them to be carried out with the liquids when the dump valve is opened. If the valve is left open, the liquids will drain off, leaving solids in the tank. Should this accidentally happen, disconnect the hose, fill the tank about half full with water, and drive a few miles to dislodge the solids. A few starts and stops will aid in the process. Then reconnect the hose and drain in the normal manner.

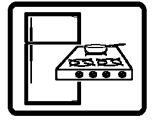

(See also Safety Precautions, Section 1 of this manual.)

*NOTE: Some items described in this section may be optional and may not apply to your vehicle.*

The appliances installed in your motor home are manufactured by reputable RV appliance makers and have been tested by independent laboratories to meet all applicable standards and codes set for RV appliances. These appliances are covered by your New Vehicle Limited Warranty. (Certain items may be covered by individual manufacturer's warranty.) See your New Vehicle Limited Warranty for details.

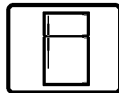

### REFRIGERATOR (3-Way Powered)

The refrigerator in your coach can be operated from any of three power sources available to the motor home:

- 110-Volt AC electric
- 12-volt DC electric
- LP gas

The refrigerator is an absorption type which uses an ammonia-water solution for cooling. Basically, ammonia vapor is distilled from the solution by heat, produced from either LP gas or electricity and then carried to the finned condenser where it liquifies. The liquid then flows to an evaporator where it creates cold temperatures through evaporation.

*NOTE: The 12 volt operating mode is the least efficient method and should be used only to "hold" the cold while traveling (not for initial cool-down or temperature maintenance). Always use either the 110-volt AC or LP Gas operating modes while parked or for pre-cooling refrigerator before use.*

*The 12 volt mode operates continuously (not thermostatic) and will discharge the*

*auxiliary battery rapidly if left on without the van engine running to recharge it.*

### LEVELING

Always park the vehicle on a level location when operating the refrigerator

Normal vehicle leveling to provide comfort for the occupants is satisfactory for refrigerator operation. This will be well within the operation limits of 3° off-level side to side and 6° off-level front to back.

A small round Bubble Level is provided with your refrigerator. Place the bubble level on the bottom inside surface of the refrigerator and watch the position of the bubble in relation to the circle on top of the level.



Place bubble level in refrigerator

If over 1/2 of the bubble is inside the circle in any direction, the coach is level enough for continuous operation of the refrigerator.

### CAUTION

To prevent permanent damage to the refrigerator cooling unit, turn the refrigerator off if the vehicle will be parked on an incline of over 3° side-to-side or 6° front-to-rear (such as steep driveways or parking lots, etc.) for more than one hour.

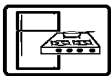

## OPERATING INSTRUCTIONS

### NORCOLD 3163

The refrigerator controls are located at the top front of the refrigerator.

The Lighting and Start-up Instructions are located on the top portion of the interior door liner.

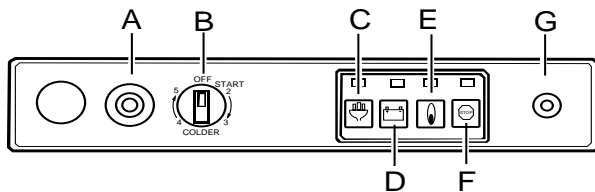

### Gas (LP) Operation

Use while parked without shoreline connection.

1. Set thermostat (B) to the start setting.
2. Place the mode selector button (E) to the gas position. Ignition spark will be present at the burner.
3. Push and hold the safety valve button (A) until the indicator lamp (G) glows steady. Continue to hold the safety valve button in for 15 seconds and then release. The indicator lamp should remain a steady glow. If the lamp turns off, repeat this step.

**NOTICE:** On initial start-up, it may take longer for the burner to light because of air being purged from the gas supply line.

### WARNING

Do not hold gas valve in more than 30 seconds. If the flame is not indicated within this time, turn the gas at the selector switch (F) off, and wait 2 minutes and retry. Continuing to hold the gas valve in will cause gas to build up in the burner area and can result in an explosion which can cause property damage or severe personal injury.

4. Set thermostat (B) to desired temperature setting.

### AC (Shoreline) Operation

Use while connected to shoreline pole.

1. Place the mode selection button (C) to the AC position.
2. Set the thermostat (B) to the coldest (maximum) setting. Allow to operate at maximum setting for 6 to 8 hours before setting to mid range.

### DC (Battery 12V) Operation

Use while driving.

1. Place the mode selection button (D) to the DC position. There is no need to set thermostat to any setting. The DC operation is a continuous run (no thermostat control) mode.

### SHUT-DOWN: ALL MODES

1. Place the mode selector button to the off position. This will interrupt all AC and DC power and stop operation of the refrigerator.

### OPERATING TIPS

- The refrigerator should already be cold before placing items in it.
- Food and beverages should also be cold before placing in RV refrigerator. Never put warm or hot items in a cold refrigerator.
- Do not pack the refrigerator too full. The refrigerator needs room for cold air to circulate.
- Use smaller containers for each item. (e.g. a half gallon container of milk instead of a half-full gallon jug)
- Always put foods, especially liquids, in tightly sealed containers.
- Use crumpled paper between loose items to reduce rattling or “clinking” noises.

### Further Information

See the Norcold operating instructions provided in your Owner InfoCase for further information, including precautions and periodic maintenance.



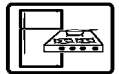

## OPERATING INSTRUCTIONS

### NORCOLD -N300 (Rialta 22HD models)

The refrigerator controls are located at the top front of the refrigerator.

The Lighting and Start-up Instructions are located on the top portion of the interior door liner.

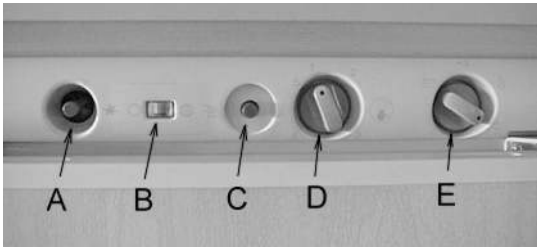

### Gas (LP) Operation

Use while parked without shoreline connection.

1. Set thermostat (D) to the start setting.
2. Place the mode selector button (E) to the gas position. Ignition spark will be present at the burner.
3. Push and hold the safety valve button (C) and repeatedly press the spark ignitor button (A) until you see the flame indicator needle (B) move to the far right (green) side of the meter. Continue holding the safety valve button (C) for at least 15 seconds then release. The flame indicator needle (B) should remain to the right (green) side of the meter. If the needle moves back to the left (white) side of the meter, the flame is not lit and you must repeat this step.

**NOTICE:** On initial start-up, it may take longer for the burner to light because of air being purged from the gas supply line.

### WARNING

Do not hold gas valve in more than 30 seconds. If the flame is not indicated within this time, turn the gas at the selector switch (E) off, and wait 2 minutes and retry. Continuing to hold the gas valve in will cause gas to build up in the burner area and can result in an explosion which can cause property damage or severe personal injury.

4. Set thermostat (D) to desired temperature setting.

### AC (Shoreline) Operation

Use while connected to shoreline pole.

1. Place the mode selection button (E) to the AC position.
2. Set the thermostat (D) to the coldest (maximum) setting. Allow to operate at maximum setting for 6 to 8 hours before setting to mid range.

### DC (Battery 12V) Operation

Use while driving.

1. Place the mode selection button (E) to the DC position. There is no need to set thermostat to any setting. The DC operation is a continuous run (no thermostat control) mode.

### SHUT-DOWN: ALL MODES

1. Place the mode selector button to the off position. This will interrupt all AC and DC power and stop operation of the refrigerator.

### OPERATING TIPS

- The refrigerator should already be cold before placing items in it.
- Food and beverages should also be cold before placing in RV refrigerator. Never put warm or hot items in a cold refrigerator.
- Do not pack the refrigerator too full. The refrigerator needs room for cold air to circulate.
- Use smaller containers for each item. (e.g. a half gallon container of milk instead of a half-full gallon jug)

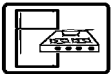

**SECTION 8**  
**APPLIANCES & INTERIOR FEATURES**

*Rialta*

- Always put foods, especially liquids, in tightly sealed containers.
- Use crumpled paper between loose items to reduce rattling or “clinking” noises.

**Further Information**

See the Norcold operating instructions provided in your Owner InfoCase for further information, including precautions and periodic maintenance.



**RANGE TOP**

The range top in your motor home operates on LP gas and will provide many of the functions that the range in your home does.

The following warning label has been located in the cooking area to remind you to provide an adequate supply of fresh air for combustion.



Unlike large homes, the oxygen supply inside a recreational vehicle is limited due to its size. To avoid danger of asphyxiation, provide proper ventilation when using the gas rangetop or gas oven. It is especially important not to use the gas oven and range top for comfort heating. Danger of asphyxiation is greater when these appliances are used for long periods of time.

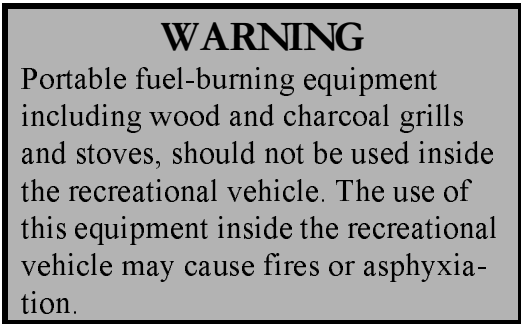

**Lighting Burners**

1. Light match and place near burner.

2. Turn control knob left (counterclockwise) to the “ON” position.
3. When the burner lights, adjust the flame height by turning the knob toward the “OFF” position.

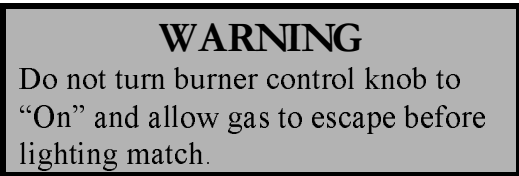

**MICROWAVE OVEN**

For complete operating instructions, refer to the manufacturer’s information provided with the oven.

**MONITOR PANEL**

**Model 22FD & 22HD:** The monitor panel is located on the left sidewall transition panel near the galley sink.



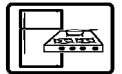

**Model 22QD:** The monitor panel is located on the wall near the left rear dinette seat. Press the corresponding buttons to test levels of the water tank, holding tanks. LP gas tank and battery condition. There is also a water pump switch with an indicator to show when the pump is active.



## WATER AND HOLDING TANK LEVELS

Press and hold the appropriate button to show approximate tank level on the monitor gauge lights.

Approximate levels of the fresh water and holding tanks are measured by sets of electronic probes in the sides of the tanks. The liquid must be at or above a probe to illuminate the indicator lights to a given level.

For example, a water level of 1-2" above the 1/3 probe would register as only 1/3 full. Consequently, a level of merely 1" below the 1/3 probe would register empty. Generally speaking, there is actually more liquid in a tank than indicated.

## LP GAS LEVEL

Press and hold the "Levels Test" switch to show approximate LP tank level.

The LP level is registered by a sending unit on the tank. The gauge mounted on the side of the tank will give a more accurate indication of actual tank level if needed.

## WATER PUMP SWITCH

When use of the self-contained water system is desired, turn the "Water Pump" switch on. Water will be available as soon as a faucet is opened. Refer to "Fresh Water System" for additional information on the water pump and initial start-up.

## BATTERY CONDITION METER

Push the "Batt Cond." button to check the level of charge (voltage) in the 12-volt coach battery. The colored segments (red, yellow and green) will light up to the amount of charge the battery contains.

- \* Green - good or adequate charge.
- \* Yellow - marginal charge.
- \* Red - battery needs charging before use.

## ELECTRIC WATER HEATER

The all-electric water heater is very simple to operate and maintain. The water temperature has been factory pre-set, eliminating the need for a thermostat control. It is powered by 110-volt current supplied from the shoreline or auxiliary generator, or by heat from the vehicle's coolant system. (See MOTOR AID).

Refer to your Owner InfoCase for further information.

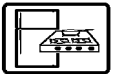

**WARNING**

Hydrogen gas can be produced in the water heater system served by a water heater that has not been used for an extended period of time, usually two weeks or more. Hydrogen gas is extremely flammable. Due to risk of injury under these conditions, it is recommended that the hot water faucet be opened at the sink and the system totally filled before turning on the water heater. If hydrogen gas is present in the water system, there will probably be an unusual sound such as air escaping through the pipe as the water begins to flow. NEVER smoke or allow open flames near the faucet at the moment it is first turned on after an extended idle period or refilling of an empty system.

**Water Heater Operation Instructions**

1. Fill the fresh water tank or connect the coach to a city water supply.
2. Turn the water pump switch or city water supply on.
3. Fill the water heater tank by opening the hot water faucets until all air has escaped and water flows freely.
4. Plug the shoreline cord into a proper 30-amp outlet or use the auxiliary generator.
5. Turn the water heater switch on.



Model 22FD

Water Heater Power Switch



Water Heater Power Switch

Model 22QD/22HD

**CAUTION**

Never turn the water heater switch on until water heater has been filled with water. Always drain the water heater when there is any chance of freezing.

To turn the water heater off, simply turn the water heater switch off.

**ELECTRIC WATER HEATER MAINTENANCE**

**Draining**

Before draining the water heater, be sure that the power switch is off.

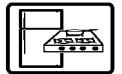

The drain is attached to a tube that exits through the floor of the coach. You can let the water drain onto the ground or into a suitable container.

Also open the Pressure-Temperature relief valve at the top right portion of the tank to prevent air locking in the tank while draining. See “Pressure-Temperature Relief Valve”.

**To drain the water heater:** Turn the valve all the way to the left (counterclockwise) to the stop position.

**To close the valve:** Turn the valve to the right (clockwise) to the stop position.

**Model 22FD:** The water heater drain valve is located below an access hole beneath the bed-board at the head of the rear bed in the left (driver side) rear of the coach. Lift or remove the bed mattress to expose the access hole.

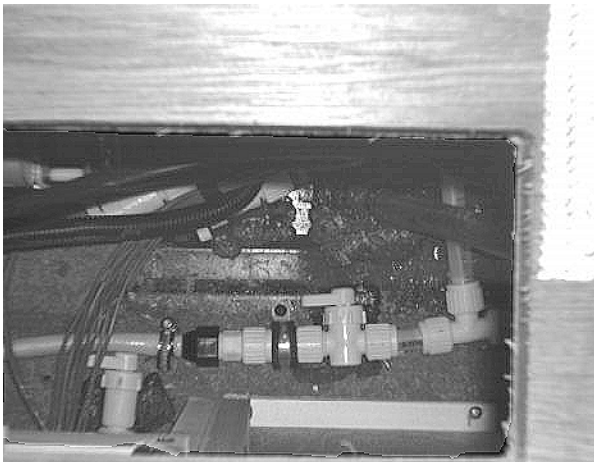

Beneath Rear Bed Mattress - Model 22FD

**Model 22QD/22HD:** The water heater drain valve is located beneath the left rear dinette seat. Lift the seat cushion assembly to access the valve.

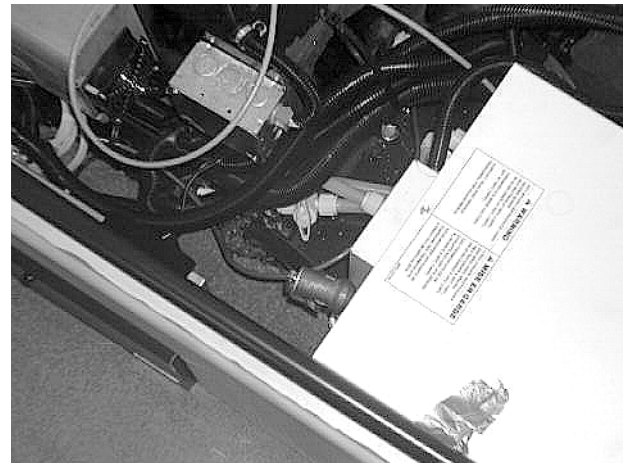

Water Heater  
Beneath Left Rear Dinette - Model 22QD/22HD

## WATER HEATER PRESSURE TEMPERATURE RELIEF VALVE

On occasion, water may be seen seeping from the water heater pressure temperature relief valve. This is no cause for repair or replacement of the valve.

Normally, there is an air gap at the top of the water heater tank which acts as a pressure buffer. In time, however, expanding water may absorb this air gap, causing a slight increase in pressure. This may cause the P-T valve to “weep” until the air gap is replaced manually.



Pressure-Temperature Relief  
(P-T) Valve

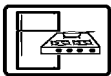

Manually operate the pressure thermostat relief switch at least once a year. **OPERATE THIS VALVE ONLY WHEN THE WATER HEATER AND COOLING SYSTEM ARE COLD!**

**To Replace the Air Gap:**

1. Turn off the water heater switch and incoming water supply (city water and/or demand pump).
2. Open a faucet in the motor home.
3. Pull the handle of the P-T valve straight out and allow water to flow until it stops.

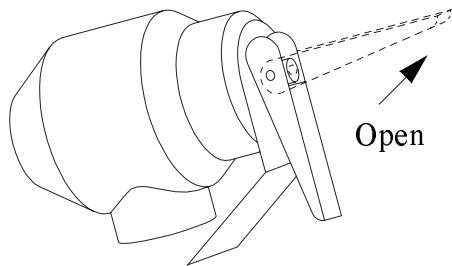

P-T Valve

4. Let the handle of the P-T valve snap shut.
5. Close the faucet before switching the water heater on.

Manually operate the pressure temperature relief valve at least once a year. **OPERATE THIS VALVE ONLY WHEN THE WATER HEATER AND COOLING SYSTEM ARE COLD!**

**Water Heater Circuit Breaker**

A circuit breaker is located behind the service panel on the rear side of the water heater.

If the water heater will not operate, first check that the water heater power switch is on, then check the water heater breaker on the load center panel.

If the switch and breaker are both on, then check the breaker at the rear of the water heater. If the rear breaker is not tripped, see your dealer for service.

**MOTOR AID**

The motor aid uses heat from the chassis engine cooling system to heat water in the water heater while driving. Hoses are routed from the

engine to a heat exchanger surrounding the water heater tank.

Under normal conditions, the entire contents of the water heater can be heated to about 140°F in about two hours or 100 miles of driving. This means you can have hot water at the faucets immediately upon arriving at a site, or even while driving if needed.

The motor aid also increases the capacity of the engine cooling system, allowing the engine to run cooler under many conditions.

**CAUTION**

Any leak in the heat exchanger or its supply or return lines could cause loss of coolant and subsequent engine failure. We recommend that you periodically inspect these connecting lines and the heater to insure that no leaks have developed.

**Motor Aid Water Heater and Rear Auxiliary Heater Maintenance**

Have your authorized dealer check all hose clamp connections on the rear automotive heater and the motor aid water heater at least every six months and tighten them if necessary. We also recommend that you periodically lubricate the rear heater control cable (models 22QD & 22HD) with powered graphite or a silicone based spray lubricant to aid in ease in operation.

**LP GAS FURNACE (SUBURBAN)**

Your furnace is equipped with an automatic ignition circuit which lights the main burner when the thermostat demands heat.

The gas furnace is designed to provide safe and efficient heat throughout the interior of your motor home through the use of the LP gas and 12-volt electrical systems. The LP fuel is converted to heat at the burner and heats the metal heat exchanger. A fan switch inside the furnace turns the blower on automatically when the heat exchanger reaches a pre-set temperature. The blower then forces this heat out through the front of the furnace.

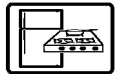

It is normal for the blower to turn on and off once or twice at the end of an operating cycle to extract as much heat as possible from the exchanger.

Refer to your Owner InfoCase for further information.

### Operating Instructions

1. Close main LP tank valve.
2. Turn thermostat switch ON. The thermostat is located on the wall near the right rear dinette seat.

Temperature Selector

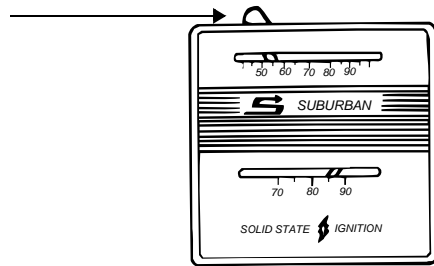

Thermostat Switch

3. Set thermostat above room temperature to begin blower operation. A slight delay will occur before the blower comes on. Allow blower to run for 5 minutes for combustion chamber purge cycle.
4. After 5 minutes, move thermostat lever below room temperature. Blower will remain on. Wait approximately 2 minutes for blower to go off.
5. Open LP gas tank valve.
6. Set thermostat to desired temperature. If set above room temperature, blower will come on.
7. Allow 30 seconds for main burner to light after blower comes on. This furnace is equipped with an ignition device which automatically lights the burner. Do not try to light the burner by hand.
8. If burner does not light, repeat Steps 1 thru 5. (If heat does not come out of the heat duct after a minute or so, the burner is not lit.)
9. If after three (3) attempts with no ignition, go to shut-down and contact your dealer or a local recreational vehicle service center. Do

not continue to cycle furnace through thermostat in an attempt to get ignition.

*NOTE: For normal operation after initial start-up, be sure the thermostat switch is ON, then place the temperature selector to the desired temperature. The furnace will start and cycle on and off automatically.*

### To Shut Down:

1. Move thermostat switch to "OFF" position
2. Close LP tank valve.

### For Further Information

Please see the Suburban furnace operating instructions provided in your Owner InfoCase for further information, including operating precautions, and periodic maintenance.

### ROOF AIR CONDITIONER

Refer to the manufacturer's information in your Owner InfoCase for complete operating instructions.



### TV ANTENNA

The TV antenna on your motor home can be easily raised, rotated a full 360° and lowered from inside the vehicle by simply turning a crank or rotating knob. The antenna has a built-in signal amplifier designed to strengthen signals, which is controlled by a power switch built into the TV jack assembly. The TV jack plates are mounted on the underside of the dinette overhead cabinet.

### Operation

**Raising Antenna** - Turn elevating crank clockwise in "UP" direction about 13 turns or until some resistance to turning is noted. Antenna is now in operating position. Turn amplifier power switch "ON" to receive TV signal.

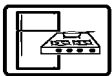

**Rotating Antenna** - Make sure antenna is in the "UP" position. Pull down on rotating knob until it disengages ceiling plate and rotate for best picture and sound on TV set.



**Lowering Antenna to Travel Position** - Rotate antenna until pointer on rotating knob aligns with pointer on ceiling plate.

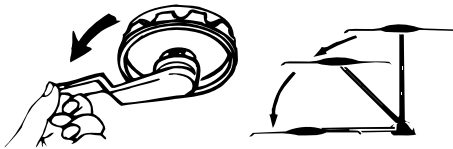

**CAUTION**

Never leave the antenna partially raised or partially lowered. This can damage the crank mechanism gears. Always raise the antenna straight up or lower it completely into the travel position.

Turn elevating crank (counterclockwise) in "DOWN" direction until resistance is noted. Antenna is now locked in travel position. Turn amplifier power switch "OFF".

Count the number of turns needed to crank the antenna down to the roof of the unit (normally about 13). Mark the final position of the crank handle on the ceiling or the directional knob for reference. Also mark the number of turns needed. Use the mark and number as a reference whenever you lower the antenna.

**CAUTION**

Always align directional handle to "DOWN" position before lowering.

**SIGNAL AMPLIFIER**

To operate the antenna signal amplifier, turn on power switch.

The amplifier power switch is located on the main TV jack plate.

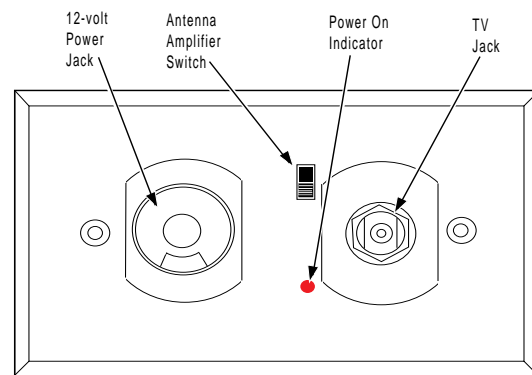

**Model 22FD/Twin:** The TV jack plate is located on the left hand side of the center night stand.

**Model 22FD/Queen:** The TV jack plate is located on the rear side of the vanity cabinet.

**Model 22QD:** The TV jack plate is located on the right hand underside of rear overhead cabinet.

**Model 22HD:** The TV jack plate is located on the front end of right hand rear overhead.

**Checking Performance**

To check the antenna amplifier, raise the antenna, select a TV channel and rotate the antenna for best picture. Then turn off the amplifier power switch. If the antenna amplifier is working properly, the TV picture will now be degraded (snowy). When you turn the switch back on, the picture should again be sharp.

The TV signals available to an RV are entirely dependent on its location in relation to the transmitter. Signals may vary from strong to no usable signal at all. We recommend that the TV system be checked out in an area known to have good TV reception.



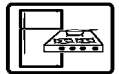

## WARNING

Never allow the antenna to touch electrical power lines or any other electrical wires.

## CABLE TV-HOOK-UPS

Some models are equipped with external connections for cable television. The connector is located in the trunk cord compartment.

*NOTE: Be sure the TV antenna amplifier switch is turned off while connected to cable. The antenna amplifier will make the cable TV signal snowy.*

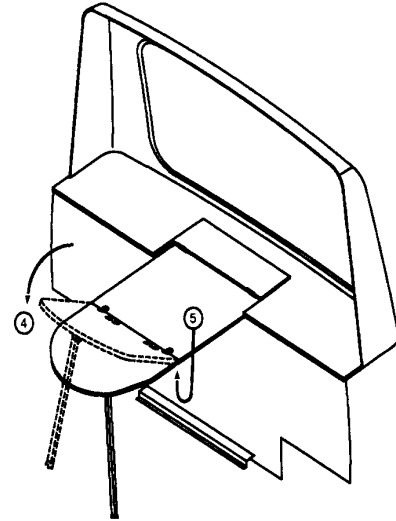

## DINETTE TABLE - Models 22QD & 22HD

The rear dinette table is stored in a pocket in the rear package shelf.

1. Open the cover on the rear shelf.
2. Grasp the two socket handles and pull the table straight upward evenly, then lower the front edge until the rear edge rests supported beneath the shelf top.

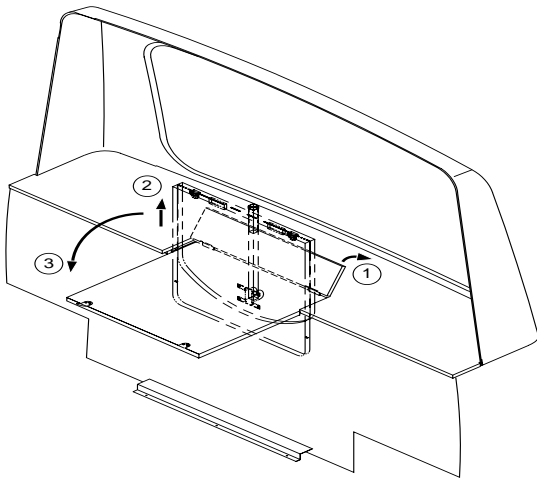

3. Unsnap the leg retaining strap and unfold the table leg upward until it clicks into the notch on the leg hinge bracket.
4. Unfold the front table half forward and lower carefully, then extend the table leg to the floor to support the front edge.

5. Turn the latches beneath the hinge at both sides of the table to lock the table halves together.
6. Reverse steps to store table.

## SLEEPING FACILITIES

### WARNING

Do not use sleeping facilities while vehicle is moving.

## DINETTE/BED CONVERSION - Models 22QD & 22HD only

The dinette seating may be easily converted into a bed as follows:

1. Store dinette table in the rear shelf pocket. (See Dinette Table above.)
2. Lift the front edge of the seat cushion assembly and pull outward while gently pushing downward on the backrest cushion. (Repeat this procedure for the opposite seat.)

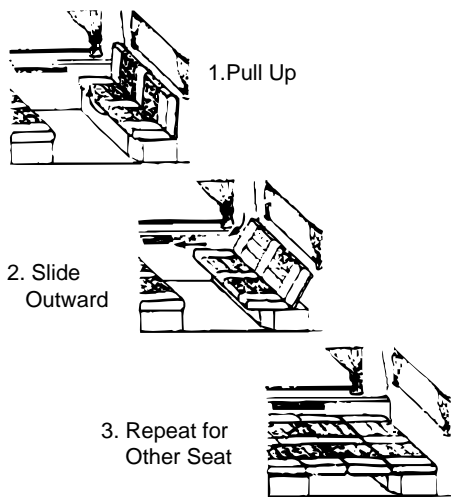
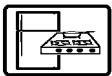

The dinette/bed is now ready for use.

Reverse the above procedure to change bed back to dinette.

**COMPANION SEAT/BED CONVERSION:  
Model 22QD only**

To convert the passenger companion seats into a bed:

1. Lift up on the seat release lever at the front of the seat.

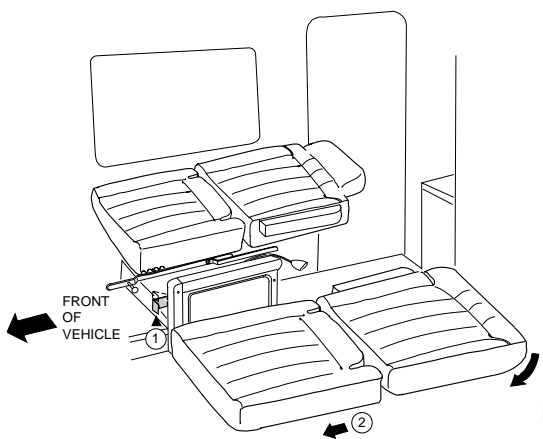

2. Lift back edge of seat cushion and swing seat cushion up and forward. Remove center bed cushion from storage location beneath seat, then swing seat cushion back down.
3. NOTE: Headrest must be removed from left (driver seat) companion seat before converting to bed. Pull upward evenly on both sides of headrest to slide out of sockets. Replace

- headrests onto seats when returning seats to upright position.
4. Lift the front of seat upward and pull forward. At the same time, push the back of the seat down so the entire seat assembly lies flat.

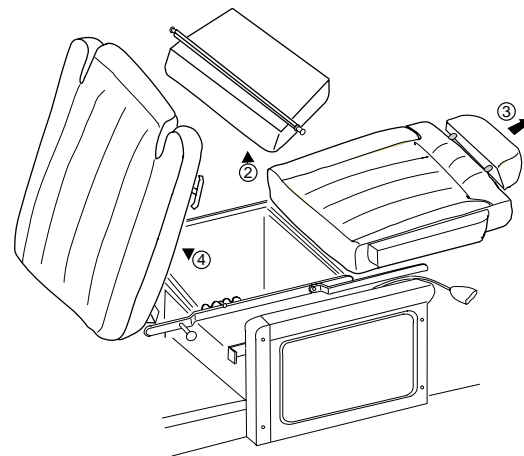

5. Repeat above steps for other seat.
6. Insert side support pegs of one center cushion into hooks beneath the front aisle side of the seats. (Center cushions are interchangeable and can be used in either front center or rear center positions.)

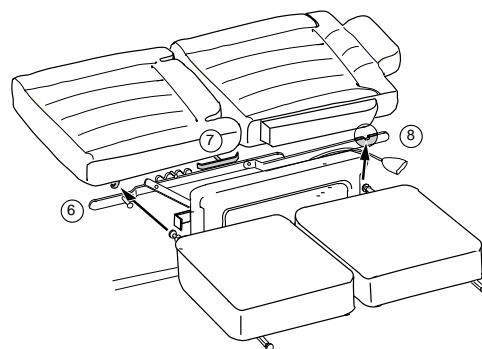

7. Pull "T" supports outward from sides of seats as shown. Swing center cushion down to rest on "T" supports.
8. Rest pegs of remaining cushion into notches at rear frame. Fold armrest down and lower cushion onto "T" supports. Raise armrests straight upward to install rear cushion, then lower armrests flush with cushion.

Reverse procedure to convert back to seating.

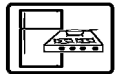

*NOTE: When returning seat to upright position, lift back of seat at same time as pushing seat cushion rearward. Be sure seat cushion locks into adjustment notches at top side of seat frame before using.*

Your companion seat/bed is now ready for use. Reverse the steps to change the bed back into seats. Remove the center cushions and store them under the seat cushion.

## WARNING

Make sure companion seats are locked into upright seating position before occupying.

## COMPACT BATH COMPARTMENT

This space-saving bathroom cabinet is designed to conveniently collapse toward the wall when not in use. When extended, it forms a full-size bathroom complete with stool, lavatory, medicine cabinet and shower.

To use the bathroom:

1. Grasp the handles on the face of the cabinet and use your thumbs to press the latch buttons as shown.

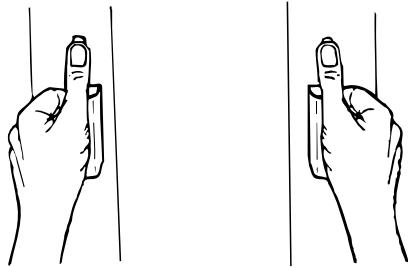

2. Pull the cabinet toward you smoothly and evenly until it is fully extended. Then release the buttons and be sure the walls are latched into position.

To collapse the bathroom:

1. Grasp the handles and press the latch.
2. Slide the cabinet smoothly and evenly toward the wall until it latches in the storage position.



## FRESH WATER TOILET

The fresh water toilet in your motor home is very similar to the household type, except that it is designed to use only a small amount of water per flush. It uses a high velocity jet of water, producing a swirl effect, to efficiently cleanse the bowl. And since each flush uses fresh water, no special chemicals are required other than a deodorizing agent, if necessary.

### Flushing the Toilet

1. Press the large (left) pedal and hold until bowl is clean. Release pedal slowly. A small amount of water will remain in the bowl.
2. To add more water to the bowl than the normal 2" automatic refill, press the small (right) pedal and hold until desired amount has been added. Release pedal slowly.

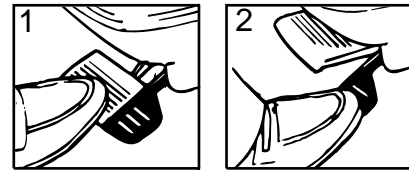

Please refer to the manufacturer's information supplied with the toilet for further operating and maintenance instructions.

### Important "Don'ts"

- Don't use facial tissue or regular toilet tissue in the RV toilet. These will not disintegrate sufficiently and will often cling to the sides of the holding tank. Toilet tissue made specifically for use in RV toilets and holding tanks is available at most RV supply centers.
- Don't dispose of sanitary napkins or other non-dissolving items in the toilet.
- Don't put automotive antifreeze or caustic chemicals, such as laundry bleach or heavy detergents into the toilet or holding tank. These products may damage plastic or rubber parts in the system.

### Cleaning the Toilet

The toilet should be cleaned regularly for maximum sanitation and operating efficiency. If an odor is apparent from the toilet:

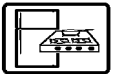

1. Clean the toilet bowl with a mild bathroom cleaner. Do not allow cleaners to set in the bowl for long periods of time to avoid damaging the seals. Do not use caustic or abrasive cleaners because it may damage the plastic surfaces.
2. Dump and rinse holding tank.
3. Add odor control chemical in amount specified after cleaning and every few days during use.
4. Remove the water line from the base of the toilet and clean the screen.
5. If the flush valve becomes stiff after extended use, it may be lubricated with a silicone spray. Turn the water pump off and operate flush pedal to drain water from the toilet bowl. Spray silicone lubricant onto flush valve inside bowl and operate flush pedal a few times to ensure free operation.

See instructions in Section 10 to prepare the toilet for storage in freezing conditions.

### FOLD-UP LAVATORY SINK

The fold-up lavatory is designed to store against the wall as a space-saving measure when not in use. The sink is equipped with a dual control sink faucet and hand-held shower head. It uses a unique drainage system similar to that of railroad pullman cars.



#### To Use:

Unsnap the strap that secures the lavatory against the cabinet and lower the lavatory into position.



Unsnap strap to lower sink

#### To Drain and Store:

Raise the front edge of the lavatory toward the wall and fasten the latch. The water contained in the basin will flow into a concealed drain cavity behind the lavatory cabinet.

### COMPACT SHOWER (Optional)

To use the shower, first lift the shower pan cover from the floor of the vehicle between the entrance stepwell and the bath cabinet door. Set the cover aside during shower use.

Next, fully extend the bathroom walls as described on the previous page.

Before turning the water on, snap the shower curtain to the walls and turn on the Shower Drain pump switch as described below.

#### Shower Drain Pump Switch

Because of the compact nature of this coach, the shower has a small sump pump to draw water from the shower floor into the sewage water holding tank while the shower is in use.

The Shower Drain pump switch is located on the face of the medicine cabinet. Press the switch to turn the pump on. A small light on the switch will glow to indicate when the pump is active.

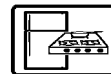

Shower Drain  
Pump Switch

Turn the pump on as you begin your shower and leave running to remove the water from the floor while showering.

Turn the pump off when the water is completely removed after finishing your shower.

### Shower Drain Strainer

The drain sump area in the shower has a strainer to keep large debris from entering the lines and damaging the pump. The strainer should be removed periodically for cleaning.



Shower Drain Strainer

The strainer screws into the floor of the sump area. If the strainer is difficult to remove, additional grip can be gained by wrapping a wash cloth around the top of the strainer.

Rinse off any debris, soap or water mineral deposits and screw back into floor.

### Shower Pump Filter Screen

The shower pump also has a filter screen that should be inspected periodically and cleaned if necessary.



Models 22QD & 22HD: The shower pump is located beneath the wardrobe cabinet and is accessible by lifting the left rear dinette seat as shown in the photo below.



Model 22FD: The shower pump is located below an access hole beneath the bedboard at the foot of the rear bed in the left (driver side) rear of the coach.

- Lift or remove the mattress from the rear bed to expose the access hole in the bed board.

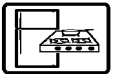

**To clean shower pump filter:**

- Push in on the filter cover and twist to the left.
- Pull the cover off and remove the screen.
- Rinse screen out under clean running water.
- Place screen back into filter housing.
- Replace cover by pushing in and twisting to the right.

**Shower Valve Pressure Bleed-Off**

After using the shower, you may notice water dripping from either the shower head or the faucet assembly. The dripping results when vacuum in the shower hose (after closing the shower valve) slowly dissipates and allows water remaining in the hose to drain down. This is a normal water pressure bleed-off function of the shower valve assembly and is not a leak or defect.

The International Association of Plumbing and Mechanical Officials: Standard TSC 21-85 (PAR. 4.3) states:

“Shower heads which incorporate shutoff valves, shall have a minimum “drip rate” of one (1) quart in thirty (30) minutes.”

**CRANK-OUT SIDE WINDOWS**

Turn the crank-out knob clockwise to open window; counterclockwise to close. Do not use excessive force on the knob to open or lock into closed position. This could cause permanent damage to the crank mechanism. The knob has finger indentations so you can simply spin the knob with your fingertips; or you may fold the

small crank handle out and use it like a standard window crank.

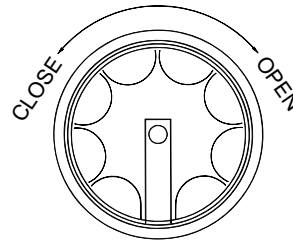

If the window will not open after three or more full turns of the knob, the glass may be stuck to the sealing gasket. Go to the outside of the coach and gently free the glass with your fingers. A periodic light dusting of talcum powder on the gasket should prevent this from recurring.

**VERTICAL SLIDER WINDOWS**

Vertical slider windows have a spring-loaded catch on one side of the window that pops out when the window is raised to hold the window fully open. To close the window, press the catch toward the frame while lowering the window.



Vertical Window Catch

**POWER ROOF VENT**

When the fan speed selector is in any of the three “ON” positions (lo-med-hi), the fan will start automatically as the vent is cranked open. The fan will stop when the vent is closed. If fan is not desired, turn selector to “OFF”.

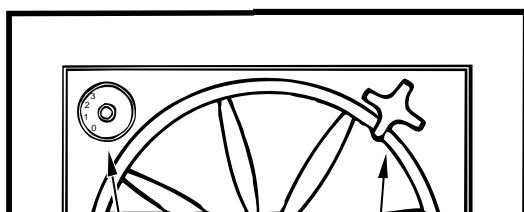
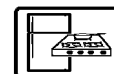

Fan Speed Selector

Dome Operation

Power Roof Vent

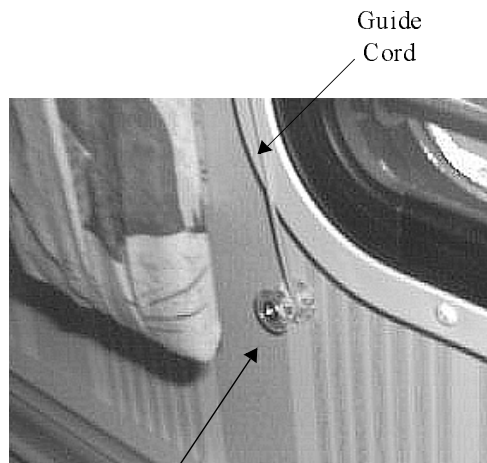

Guide Cord

Spool

## PLEATED WINDOW SHADES

Raise or lower the pleated shades evenly by grasping in the center of the lower edge using one hand or by grasping both ends of shade with both hands.

### Preserving Shape:

We recommend that you fully raise pleated shades when they are not needed, especially in warm environments, to preserve their pleated shape. The pleated shades are made using high quality materials that are designed and woven to retain their shape throughout their useful life. They may lose their crisp shape, however, if left in a lowered position for an extended period of time without being raised periodically.

### Tension Adjustment:

The tension of the pleated shades can be adjusted if they become loose and will not stay up when raised, or they are too tight and are difficult to raise and lower.

*To tighten the tension*, simply wrap the lower end of the guide cords (on each side of the shade) a few turns around the spools at the lower corners of the shades.

*To loosen the tension*, unwrap the guide cords from the spools one turn at a time until desired tension is achieved.







### EXTERIOR

#### CAUTION

Sealants must be inspected every 6 months and resealed if necessary.

#### ROOF

The roof is made of Thermo-Panel materials like the walls and floor. It will support the weight of an average adult should it become necessary to repair the roof or roof mounted components. It is not recommended, however, that very large or heavy objects be carried on the roof while the vehicle is in motion. (See page 4-1 for roof loading specifications.) Always have damage to the roof area repaired immediately. Damaged or detached sealant around the vents, air conditioner, body-to-roof seams, etc., should also receive immediate attention. Delaying these repairs may allow water leakage and result in damage to interior ceiling and body panels, upholstery, etc.

#### UNDERBODY

Buildup of mud and dirt under the body can cause damaging rust on steel parts and can add needless weight to the vehicle. This, in effect, reduces the amount of cargo you can carry and remain with GVWR and GAWR limits.

Corrosive materials, such as those used for ice and snow removal and dust control, also accumulate on the underside of a vehicle. These materials should be removed by flushing the underbody regularly with water, especially areas where mud and other foreign materials collect.

#### BODY FINISH

The exterior surface of your motor home has an automotive finish. Frequent washing and thorough cleaning is recommended to prevent damage to the vehicle finish after exposure to damaging salts, calcium chloride, road tar, tree sap, insects and other foreign material. Never wash the vehicle in direct sunlight, while the vehicle surface is hot, or using hot water.

Do not use strong soaps or detergents for washing the motor home. Always use a mild soap in warm water, a commercially prepared product

for cleaning automotive finishes or your local car wash. Be careful when using pressure-type washers to avoid loosening exterior decals or sealants, etc.

After washing the motor home, carefully inspect caulking around window frames and vents and any other joints that may have separated. Recaulking, if necessary, is quite simple. Appropriate compounds are sold at Winnebago and Itasca dealers, and the materials are quickly and easily applied. Also, inspect weather seals around door, etc., and if necessary have a dealer replace them immediately.

#### CAUTION

Never use a strong solvent such as lacquer thinner, or harsh abrasives on painted surfaces.

#### Waxing and Polishing

When water will not bead up and roll off the finish of your freshly washed vehicle, it's time to apply a new coat of hard wax (paste, not liquid) to the finish. Wax not only improves the appearance of the vehicle, but protects the finish against oxidation and corrosive substances.

We recommend using a wax that is compatible with painted and gel-coated fiberglass finishes.

If the finish begins to look dull or discolored, it may need to be cleaned with a polishing or cleaning compound.

*NOTE: If you use a polish or a cleaning compound that does not contain a wax preservative, we recommend reapplying a coat of hard wax after cleaning or polishing the finish.*

#### Touch-Up Paint

If the finish becomes chipped or scratched, your Rialta dealer has touch-up paint and other materials available that you can use to repair these areas.



**STRIPES  
AND DECALS**



The pressure-sensitive decals on your coach require very little maintenance. They should be treated like any painted surface on your vehicle.

Here are a few helpful hints on caring for decals:

- Wash decals with plain soap and water or any retail car wash soap. Always rinse thoroughly.
- Keep high-pressure wash nozzles at least 12 inches from edge of decals. High pressure water spray may cause edge lifting of decals.
- Test any cleaning solution on a small section of decal before using.
- Do Not use any aromatic solvents such as acetone, MEK, toluene, xylene, etc., on decals. Any solvent including alcohol may soften or smear colors.
- Do Not use lacquer thinner or paint on decals. Do Not overcoat decals with clear paint.
- Do Not let gasoline or other fuels drip and stay on decals for any length of time. Rinse immediately.

---

**INTERIOR**

**UPHOLSTERY, CARPETING AND  
DRAPERIES**

We recommend a weekly routine of vacuuming all fabrics and carpet throughout the motor home to prevent an accumulation of dirt which can detract from the appearance and shorten the life of carpet and fabrics.

Some fabrics used in this motor home may contain fire retardant and lightfastness additives which can be damaged by use of improper cleaning products. Some water-based household cleaning products. Some water-based household cleaning products are not formulated for use on fabrics and may cause excessive shrinkage or fading. Always test any cleaning product on a

hidden area of fabric before using on visible areas. For best results, fabric cleaning should be referred to a professional carpet and upholstery cleaner.

*NOTE: To minimize fading of upholstery, carpets and other interior fabrics caused by excessive sunlight, the drapes, blinds or shades should be closed when the motor home is parked for an extended period of time.*

**WARNING**

When cleaning upholstery and fabric, do not use lacquer thinner, nail polish remover, laundry soaps, or bleach. Never use carbon tetrachloride, gasoline, or naphtha for any cleaning purpose. These materials may cause damage to the material being cleaned and most are highly flammable.

**SPOTS AND STAINS**

Spots or stains should be treated as soon as possible before they “set in” to avoid permanent damage. Always start from the outside of a spot or stain and work inward to avoid spreading it. Use a clean cloth or sponge and turn frequently to an unused area of the cloth or sponge as you clean.

Some stains or soils, such as lipstick, ink, grease or mustard, are extremely difficult or impossible to remove completely and should receive immediate attention. Consult a professional carpet and upholstery cleaner for assistance.

**VINYL FABRICS**

Vinyl should be cleaned with a soft, damp cloth, and a mild detergent only. Do not use solvents. Solvents may damage the surface of the vinyl.

**DRAPERIES, CURTAINS AND  
BEDSPREADS**

These items may be woven from a variety of fabrics. We recommend that these be profession-



ally dry cleaned only. A five percent shrinkage may occur when you have these items dry cleaned.

---

## CABINETRY

Wooden items may be cleaned with a soft cloth and a good quality wood finish cleaning product such as Guardsman™ or equivalent.

Vinyl simulated wood (Plus-Wood) panels may be cleaned with a mild, water based cleaner and a soft cloth. Do not use solvents on vinyl wood panels.

*NOTE: Some cabinetry and furniture items throughout this motor home are constructed either partially or completely of real hardwoods. Because of natural variations in woodgrain density, slight differences in stain hue may exist between one item and another. This is the distinctive character and beauty of real wood.*

---

## VINYL WALLBOARD

Decorative vinyl covered wallboards may be cleaned with a mild solution of water and isopropyl (rubbing) alcohol or a mild soap solution. Do not use solvents or abrasive cleaning products.

---

## TABLES AND COUNTERTOPS

Work surfaces are covered with a plastic laminate that resists solvents, stains and abrasions. A coat of furniture wax applied to these surfaces on the counters and table will help preserve their beauty and make cleaning easier. Always clean the surface before applying wax.

---

## STAINLESS STEEL SINK

The stainless steel sink can be cleaned with soap or detergent. Rinse thoroughly with warm water and wipe dry to avoid streaks.

Use a mild abrasive for stubborn stains. Work in the direction of the polish lines. To keep the original finish, polish with a wax cleaner and rub with a dry soft cloth.

### WARNING

Salts, mustard and mayonnaise may cause pitting. If spilled, clean immediately.

---

## RANGE AND REFRIGERATOR

For care and appearance maintenance of the range and refrigerator, refer to the operation and maintenance manual for each of the individual appliances included in your Owner's InfoCase.



## BATHROOM

The tub and shower walls in the bathroom should be cleaned with a mild soap and water solution, or (to obtain maximum luster) use a good quality wax cleaner. Do not use an abrasive cleaner on the shower walls and tub. If the shower has a glass door, it is extremely important that abrasives not be used. Use only a good quality glass cleaner or mild detergent and water solution with a soft cloth to clean glass surfaces.

The bathroom lavatory is also a molded plastic material and should be cleaned with a mild soap and water solution. Abrasive cleaners or harsh detergents should not be used.

For instructions on the care of your fresh water toilet, refer to the information in your Owner's InfoCase.



## DOORS AND WINDOWS

Windows may be periodically cleaned with a good quality glass cleaner or mild soap solution using a soft cloth. Use care when removing ice or frost from the windows. Always use a plastic ice scraper, never one made of metal. Use care when removing ice from the mirrors to protect the reflective surfaces.

Door locks and hinges should be lubricated periodically with powdered graphite to ensure



## SECTION 9 CARE & MAINTENANCE

# Rialta

trouble-free operation and to protect against freeze-up.

### WINDOW ROLL-UP SHADE ADJUSTMENT

If a roll-up type window shade in your motor home does not roll up or down fully, the spring tension may need adjustment.

#### Spring Too Weak:

- Roll shade about half-way down on window.
- Remove shade from bracket.
- Roll shade snugly by hand and replace onto bracket.

#### Spring Too Strong:

- Roll shade all the way up.
- Remove shade from bracket.
- Unroll shade one or two turns as necessary by hand and replace onto bracket.



## VEHICLE MAINTENANCE

(See also Safety Precautions, Section 1 of this manual).

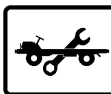

## CHASSIS SERVICE & MAINTENANCE

Consult the appropriate sections in your Volkswagen chassis owner's manual for specific information regarding operating safety, service recommendations and maintenance schedules for the Volkswagen chassis section of your motor home.

### ENGINE ACCESS

Refer to your Volkswagen chassis owner's manual.



## ENGINE COOLING SYSTEM

Refer to your Volkswagen chassis owner's manual guide for information and precautions on filling, servicing and checking the fluid level.

### CAUTION

When refilling the coolant system of a vehicle with a rear auxiliary automotive heater and/or motoraid water heater, be sure to allow for the additional coolant capacity of the heater(s) and supply and return hoses.

### REAR WINDOW WASHER RESERVOIR LEVEL CHECK

Check the rear window washer reservoir level frequently. The reservoir is located inside the trunk compartment on the rear exterior of the coach.

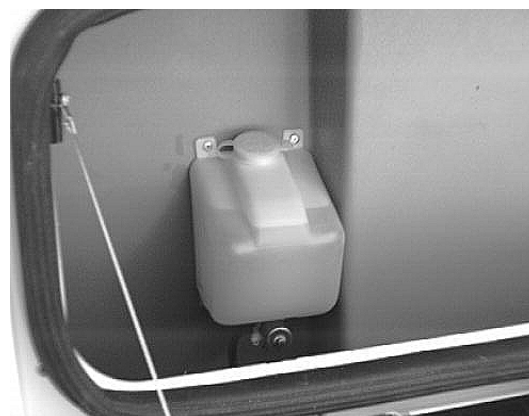

*NOTE: A commercial windshield washer/anti-freeze solution is recommended to aid on removal of foreign matter and debris from glass surfaces and to protect the system from damage during freezing temperatures.*



## TIRE PRESSURE AND CONDITION

Your vehicle's tire inflation pressure must be checked at regular intervals when tires are cold, and filled to the tire manufacturers recommendations. Incorrect cold inflation pressures (high or low) lead to abnormal tire wear and unusually hot running temperatures, factors which may seri-



ously affect safety and lead to poor road handling and the possibility of blow-outs or throwing of tread at high speeds.

The recommended cold fill pressure of the tires originally equipped on your vehicle is stamped on the Vehicle Certification Label located on the bottom inside of the driver's door. Maintaining the proper tire air pressure is an important factor which contributes directly to the life of the tire.

Low air pressure results in tire overloading and abnormal wear and also affects handling and fuel economy. Obtain proper inflation pressures from your Volkswagen chassis owner's manual or tire manufacturer.

*NOTE: Always include the spare tire when checking tire inflation pressures.*

The tires on your vehicle must be in good condition and must have sufficient tread depth. Replace your tires when:

1. The tires are worn to a point where 2/32 inches or less tread remains, or the cord or fabric is showing. To aid in the detection of minimum tread depth, your tires may have built-in tread wear indicators which appear as "bald spots" between the tread grooves when tread depth is 2/32 inches or less. When these indicators appear in two or more adjacent grooves at three or more spots around the tire, the tire should be replaced.
2. The tire tread or sidewall are cracked, cut or gouged deep enough to expose cord or fabric.
3. The tire has a bump, bulge or split.
4. The tire has a puncture, cut or other damage that can't be correctly repaired because of size or location of damage.

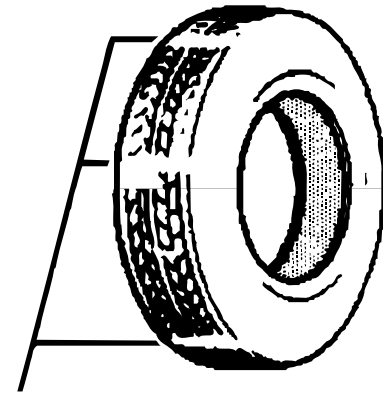

Tread Wear Indicators

## TIRE REPLACEMENT INFORMATION

DO NOT replace with passenger car tires or alternative light truck tires with a lower rating. See your Rialta dealer or a Continental brand tire dealer for details. The following label is affixed to the wheels of this vehicle. (Actual size and shape of label may vary.)

*NOTE: The tires for this motor home are constructed for a specific usage and load range to provide durability, performance, and safety.*

- Front tires are 195/65R16C, Load Range D (European Load Index 104/102), light truck tires. (In Europe, light truck tires are designated with a suffix C for "commercial.")
- For additional rear tire load capacity, the tires installed on the rear of the vehicle are size 215/65R16C, Load Range D (European Load Index 109/107).
- When replacing any of the tires on this vehicle, **replace only with tires of exactly the same size, usage type and load rating**, including the equivalent European load index rating. Tire sizes and load ranges are molded into the sidewall of each tire.

**Rotation:** DO NOT rotate rear tires to the front. There is insufficient clearance to mount the size 215/65R16C rear tire on the front of this motor home. You may, however, use the 195/65R16C spare tire to rotate with the front tires only.



**Spare:** The spare tire is a 195/65R16C, the same as the front tires. The spare tire may be used on a rear position **if inflated to 65 psi**. However, you should re-install a 215/65R16C on the rear position as soon as possible.

**Custom Aluminum Wheels:** If your vehicle is equipped with optional aluminum wheels, be sure the tire service uses mounting equipment designed for use on plated aluminum wheels to avoid scraping or abrading the wheel finish. Make sure the tire service uses adhesive balancing weights only! Clip-on weights will cut into the finish and allow moisture to penetrate beneath the plated surface.

### WARNING

Replace tire only with one of exactly same type and rating. **DO NOT** replace with passenger car tire. See Operator's Manual for details. For more information call Winnebago Owner Relations at 1-800-537-1885.

### WARNING

When replacing tires, use the same size, load range and construction type (radial) as the original tires installed on the vehicle. Use of any other size or type tire may affect ride, handling, speedometer/odometer calibration, vehicle ground clearance, and tire clearance to the body and chassis. If replacing only a single tire, it should be paired on the same axle with the least worn tire of the other three.

### WHEEL REPLACEMENT RECOMMENDATIONS

Wheels must be replaced if they become damaged (i.e. bent, heavily rusted, leak air) or if lug nuts often become loose. Do not straighten bent wheels or use inner tubes in leaking wheels. Such wheels may have structural damage and could fail without warning. When replacing wheels for any reason, the new wheels should be equal in load limit, diameter, width, offset, and mounting configuration to those originally installed on

your vehicle.

A wheel of the wrong size or type may adversely affect wheel and bearing life, brake cooling, speedometer/odometer calibration, stopping ability, headlight aim, bumper height, vehicle ground clearance, and tire clearance to the body and chassis. Replacement with "used" wheels is not advised. They may have been subjected to harsh treatment or very high mileage and could fail without warning.

Replacement wheels may be obtained at your authorized dealer.

### SUPENSION ALIGNMENT AND TIRE BALANCE

The front suspension and steering system of this vehicle was factory aligned using highly accurate equipment prior to delivery to the dealership. However, we recommend that alignment be checked and adjusted, if necessary, after you have fully loaded the motor home according to your personal needs. Thereafter, the alignment should be periodically inspected to help prevent uneven tire wear.

Any excessive or abnormal tire wear may indicate worn or misaligned suspension or steering, unbalanced tire or other tire/suspension problem.

Alignment can be affected by worn steering/suspension parts or by incidents which happen during driving, such as hitting a curb, pothole or railroad track, etc. Improper alignment can cause tires to roll at an angle and wear unevenly. It may also cause the vehicle to "pull" to the right or left. Have your dealer inspect your vehicle's suspension and steering components periodically for misalignment or wear.

Out-of-balance tires will not roll smoothly and can lead to annoying vibrations and uneven tread wear such as cupping and flat spots. Tires may need to be balanced if uneven wear is detected or if ride comfort decreases noticeably.

See your Volkswagen chassis owner's manual for further information.

**Custom Aluminum Wheels:** If your vehicle is equipped with optional aluminum wheels, be sure the tire service uses adhesive balancing weights only! Clip-on weights will cut into the finish and allow moisture to penetrate beneath the plated surface.



## REAR AIR SPRINGS (Optional)

The air springs (air bags) assist the standard suspension system to provide a smoother ride and adjustable load conditions.

The air bags can be adjusted independently if necessary to equalize a load, however we recommend maintaining the same pressure in both air bags whenever possible to ensure that the vehicle remains level.

### Adjustment

There are tire fill type valves for the air bag on each side of the vehicle, located on the lower edges of the valance panels directly ahead of the rear tires.

<b>Recommended Pressure:</b>	<b>20-30 psi</b>
Minimum Operating Pressure:	10 psi
Maximum Operating Pressure:	100 psi

### CAUTION

Never overfill the air bags so that the rear of the vehicle is higher than the front (“jacked up”) or one side is higher than the other (“leaning”).

## CARE OF CUSTOM ALUMINUM WHEELS (OPTIONAL)

- Follow the manufacturer’s instructions with regard to tire sizing and load capacities.
- Mount tires on wheels only with mounting equipment designed for plated aluminum wheels. Do not use equipment which will scrape or abrade the wheel finish.
- Use adhesive-balancing weights only! Clip-on weights will cut into the finish and allow moisture to penetrate beneath the plated surface.
- Use only manufacturer approved mounting hardware (lug bolts).
- Using a calibrated torque wrench, torque lug nuts according to your vehicle manufacturer’s specifications or, in their absence, use the following guidelines according to stud diameter; 12 mm 70 - 80 ft. lbs., 14 mm 85 - 90 ft. lbs., 1/2” 75 - 85 ft. lbs.

- Maintain proper air pressure in tires by checking tire pressures at frequent intervals. Use pressure guidelines established by your tire manufacturer.

### Finish

Your custom aluminum wheels are finished with a thin layer of bonded chromium to provide optimum finish sheen and brilliance. The finish must be maintained as you would the color finish of your vehicle.

- Clean your wheels frequently to prevent brake dust and dirt deposits from corroding or bonding to the wheel finish.
- Only use a solution of mild soap and water for cleaning your wheels.
- Do not use any spray-on cleaners or degreasers that you would not use on your car.
- Most spray-on, hose off wheel cleaners are caustic, and they are not formulated for use on the finish used on your wheel.
- Avoid car washes that use harsh detergent pre-washes which may damage the chromium finish on your wheels.
- Do not wash wheels that are very hot from recent use.
- To increase the life of the finish on your wheels, wax them regularly with a soft paste wax.







### PREPARING VEHICLE FOR STORAGE

Properly preparing your vehicle for storage will lessen the possibility of damage to your vehicle. Prepare the motor home for vacancy just as you would if you were leaving your house for an extended period:

- Remove all perishables from cabinets and refrigerator
- Prop refrigerator door open.
- Turn off LP gas tank.
- Drain water heater, water tank and holding tank.
- Close shades to protect upholstery from sunlight

When storing your vehicle through the winter, or in cold climates, extra preparations need to be made to protect systems that can be damaged by freezing temperatures.



### Cold Weather Storage Procedure (Winterizing)

1. Clean and dump holding tanks by following steps A, B, and C
  - A. Add water to the sewage holding tank by holding the toilet flush lever open with the water pump running. Add water to the waste water holding tanks by opening the kitchen, shower and lavatory faucets. Tanks should be about 1/4 to 1/3 full to rinse properly. Driving to a disposal site will normally loosen and rinse any waste material from the sides of the tank.
  - B. Completely drain the sewage and waste water holding tanks at an approved waste disposal site. Drain the sewage tank first so the following waste water can rinse any waste solids from the dump outlet and sewer hose.
  - C. Close dump valves and refit the dust cap onto the drain outlet.
2. Level the motor home and drain the entire plumbing system as described in the following steps.
3. Open all drain valves by rotating as shown. See Section 7 for drain valve location for your model.
 

IN-LINE VALVE      LINE-END VALVE
4. Turn the Water Pump switch ON to allow it to operate until you are done draining all faucets and toilet.
5. Open all faucets and shower head valves, including exterior shower.
6. Operate the toilet flush lever and hold until water stops flowing in the toilet. Then turn water pump switch OFF.
7. Drain the water heater by turning the valve at the base of the water heater tank. Also open the Pressure-Temperature relief valve at the to right portion of the tank to prevent air locking in the tank while draining. See Section 7 for drain valve locations for your model.
8. After water has stopped draining at all faucets and drain valves, connect a “blow-out” plug to the city water connection on the coach. Then use a compressed air hose regulated to 30 psi or less to force air through the system. (A “blow-out” plug can be purchased at any Winnebago or Itasca dealer. P/ N 701705-01-000.)



City Water  
Connection

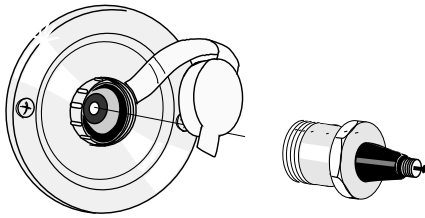

**CAUTION**

Limit air pressure to 30 psi to avoid damage to pump or water lines.

*NOTE: DO NOT burst air into the system. This can damage the water pump. It is better to let air in slowly.*

9. Let air flow for five minutes until water is completely drained out of faucets and drain valves. Then close faucets one at a time.
10. Operate and hold toilet flush lever until water is completely drained from toilet.

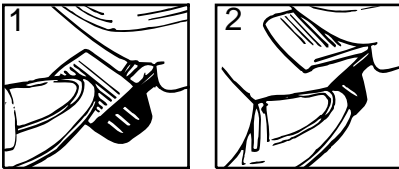

11. Now turn air pressure off and disconnect water purge adapters. Recap the city water connection to avoid contamination by dirt or insects.
12. Close all drain valves and faucets to avoid contamination by dirt or insects. Reinstall water heater drain plug and close P-T relief valve.
13. Pour about one cup of non-toxic RV antifreeze into the kitchen sink drain, bathroom sink drain and shower drain. This prevents any holding tank odors from entering the coach during storage.
14. Turn the shower sump pump on and pour 1/2 gallon of non-toxic RV antifreeze into the shower drain. Turn the shower sump pump off immediately after pouring antifreeze remains in pump and lines.

**WARNING**

NEVER use automotive antifreeze/coolant in your RV water system. Auto antifreeze contains ethylene glycol which, if ingested, can cause blindness and can be fatal.

It is not necessary to add antifreeze to the toilet since the flush valve will be closed.

Do not add automotive antifreeze or caustic chemicals such as bleach or laundry detergents into the toilet bowl or holding tanks. Although these products may have a deodorizing effect, they may damage plastic and rubber parts in the system.

*NOTE: As an alternative to totally draining the plumbing system, you may winterize tanks and lines by pumping non-toxic RV antifreeze through the system. This product is available from your dealer and from most RV supply stores. Follow directions on the container to determine the correct amount to use for your coach.*

15. Place a bucket beneath the sewage drain valve outlet and re-drain the sewage and waste holding tanks of any clean water that entered during “blow-out” procedure. Close dump valves to prevent valve shafts from rusting and to prevent entry by rodents and insects. Refit the dust cap onto the drain outlet.

Your drainage and fresh water systems are now totally winterized.

16. Have the vehicle chassis completely serviced and lubricated. Be sure radiator antifreeze protection level is sufficient for the lowest anticipated temperatures.
17. Wash and wax the coach.
18. Inspect all seams and seals around doors, windows, vents, and any other joints. Replace or repair any that are damaged. Sealing materials and compounds can be purchased from your dealer. Badly damaged weather seals may need to be replaced by your dealer.



19. Close all windows and roof vents. Protect all appliance vent openings from contamination by animals or insects (e.g. bird nests, wasp nests, etc.)
20. Lubricate all door hinges and locks.
21. Clean the interior of the coach. Dirt and stains are more easily removed when fresh.
22. Remove all foods and items that may cause odors.
23. Clean and defrost the refrigerator. Leave the door slightly ajar to allow any odors to dissipate. Place an open box of baking soda inside the refrigerator to help absorb odors.
24. Turn the furnace thermostat switch on the bottom of the thermostat to OFF.
25. Disconnect all chassis and auxiliary battery cables.
- 26. Fully charge all batteries. Batteries must have at least 80% charge to survive freezing temperatures and long periods of non-use.**

*NOTE: We do not recommend leaving the shore-line plugged in continuously during storage periods because the batteries can lose electrolytic fluids and become damaged from continuous charging without periodic use. We recommend following regular battery inspection and maintenance, especially in cold weather. See "Battery Maintenance" on page 6-7.*



## REMOVAL FROM STORAGE

1. Completely air out the motor home.
2. Have the entire LP gas system checked for leaks.
3. Check window operation.
4. Check cabinet and door hinges. Lubricate with penetrating oil, if necessary.
5. Close all faucets and drain valves that are open. If necessary, reconnect toilet water line and close flush valve.
6. Add a few gallons of water to the fresh water tank and check for leaks especially at junctions. Also make sure all hangers and supports are securely in place. Sanitize the water system as outlined under "Disinfecting the Fresh Water System" in Section 7.
7. Check operation of all faucets to be sure faucet washers have not hardened during storage.
8. Check sealing valve in the toilet for proper operation and lubricate with silicone spray.
9. Add water to the holding tank using the toilet flush pedal. Check to be sure dump valve seals tightly.
10. Check around all appliances for obstructions and ensure that all vent openings are clear.
11. Start refrigerator and check for proper cooling.
12. Clean paneling and counter surfaces and apply a thin coat of wax.
13. Replace batteries if necessary and check out electrical system to make sure all lights and electrical components operate.
14. Check tires for proper cold inflation pressure.
15. After washing accumulated winter grime from the vehicle, it is important to carefully inspect the seams and sealants for separation or cracks that may have appeared around the window frames, vents and any other joints. Re-sealing is quite simple and the material is quickly and easily applied. Appropriate compounds are available from your dealer. Also inspect weather seals around doors, etc., and if necessary, have a dealer replace immediately.



<b>A</b>		
Access, Battery .....	6-8	
Air Springs, Rear .....	9-7	
Air Conditioner, Automotive (Dash) .....	2-7	
Air Conditioner, Rear Automotive (overhead) .....	2-7	
Air Conditioner, Roof .....	8-8	
Alarm, Carbon Monoxide .....	1-6	
Alarm, LP Gas .....	1-3	
Alarm, Smoke .....	1-7	
Alignment, Suspension and Tire Balance .....	9-6	
Aluminum Wheels, Balancing (Adhesive Weights) .....	9-6	
Care of .....	9-7	
Lug Bolts .....	3-1	
Amplifier, TV Antenna Signal .....	8-9	
Antenna, TV .....	8-8	
Audio System - Radio/Cassette .....	2-7	
Automotive (Starting) Batteries .....	6-6	
Auto 12V Fuses & Circuit Breakers .....	6-7	
Auxiliary (Coach) Batteries .....	6-6	
Auxiliary Generator 110-Volt .....	6-5	
Auxiliary Start Switch .....	2-7	
<b>B</b>		
Bathroom .....	8-12	
Bathroom, Care of .....	9-3	
Batteries, Automotive (Starting) .....	6-6	
Batteries, Coach .....	6-6, 6-8	
Battery Charger, Connecting .....	3-3	
Battery Condition Meter .....	6-9, 8-4	
Battery Information .....	6-8	
Battery Maintenance .....	6-8	
Beds, Converting for use .....	8-10	
Before Driving your Vehicle .....	0-2, 2-1	
Before Entering your Vehicle .....	2-1	
Blocking .....	4-5	
Bypass Valve, Water Heater .....	7-4	
<b>C</b>		
Cabinets, cleaning .....	9-3	
Cable TV Hook-Ups .....	8-10	
Campsite Set-up .....	4-5	
Capacity Chart*		
<b>Carbon Monoxide Alarm .....</b>		1-6
<b>Carbon Monoxide Warning .....</b>		1-5
<b>Carpets, Care of .....</b>		9-2
<b>Chassis Owner's Manual, Volkswagen .....</b>		0-1
<b>Chassis Service .....</b>		9-4
<b>Checklists, Pre-Travel .....</b>		4-2
<b>Coach Batteries .....</b>		6-6, 6-8
<b>Child Restraints .....</b>		2-6
<b>Circuit Breakers, 110-Volt .....</b>		6-3
<b>Circuit Breakers, 12-Volt .....</b>		6-7
<b>City Water Hook-Up .....</b>		7-3
<b>Coach Battery .....</b>		6-6
<b>Coach Battery Access .....</b>		6-8
<b>Cold Weather Storage .....</b>		10-1
<b>Compact Shower .....</b>		8-13
<b>Companion Seat/Bed Conversion .....</b>		2-4, 8-11
<b>Condensation, Humidity and .....</b>		4-6
<b>Connecting a Battery Charger .....</b>		3-3
<b>Connecting the Shoreline .....</b>		6-1
<b>Converter, AC-DC Power .....</b>		6-2
<b>Cooling System, Engine .....</b>		9-4
<b>Couch/Bed Conversion .....</b>		8-10
<b>Crank-Out Windows .....</b>		8-15
<b>D</b>		
<b>Day/Nighter Pleated Window Shades .....</b>		8-16
<b>Decals and Stripes .....</b>		9-2
<b>Defects, Reporting Safety .....</b>		0-2
<b>Defogger, Rear Window .....</b>		2-8
<b>Dinette Table .....</b>		8-10
<b>Disinfection Water System .....</b>		7-2
<b>Door Handles and Locks .....</b>		2-2, 2-3
<b>Door Locks, Power .....</b>		2-3
<b>Doors and Windows, Care of .....</b>		9-3
<b>Drain Strainer, Shower .....</b>		8-14
<b>Drain Switch, Shower .....</b>		8-13
<b>Drain Valves .....</b>		7-3
<b>Drainage System (Sewage) .....</b>		7-4
<b>Drains, Water System .....</b>		7-3
<b>Draperies, Care of .....</b>		9-2
<b>Drinking and Driving .....</b>		0-2
<b>Driver and Co-Pilot Seats .....</b>		2-3
<b>Driving Safety Precautions .....</b>		1-1
<b>Dump Valves, Holding Tank .....</b>		7-5
<b>E</b>		
<b>Effects of Prolonged Occupancy .....</b>		4-6
<b>Electrical Outlets, 110-volt .....</b>		6-3

\* Capacity chart is also conveniently located on the back of "To The Owner" page inside front cover of this manual.

Electrical Safety Precautions .....	1-4	<b>K</b>	
Electrical System, 110-volt AC .....	6-1	Keys .....	2-2
Electrical System, 12-volt DC .....	6-6		
Electronic Thermostat .....	8-7	<b>L</b>	
Emergency Exit Window .....	1-6	Lavatory Sink, Fold-Up .....	8-13
Engine Access .....	9-4	Loading, Roof .....	4-2
Engine Cooling System .....	9-4	Loading Safety Precautions .....	1-4
Engine Overheat .....	3-2	Loading the Vehicle .....	4-1
Engine, Starting and Stopping the .....	2-2	Locks .....	2-2, 2-3
Entering Your Vehicle, Before .....	2-1	Lounge Seat .....	2-5
Exterior Body Care .....	9-1	LP Gas Alarm .....	1-3, 5-4
Exterior Feature Identification .....	0-5	LP Gas Furnace .....	8-7
External Power Cord (Shoreline) .....	6-1	LP Gas, How It Works .....	5-1
		LP Gas Leaks .....	1-2, 5-4
<b>F</b>		LP Gas Level, checking .....	8-4
Filter, Shower Pump .....	8-14	LP Gas Pressure Regulator .....	5-3
Fire Extinguisher .....	1-7	LP Gas Selection .....	5-2
Flat Tire Info .....	3-1	LP Gas System, Safe Use Of .....	5-1
Fold-Up Lavatory Sink .....	8-13	LP Gas Tank* .....	5-2
Formaldehyde Warning .....	1-5	LP Gas Tank, Air in the .....	5-3
Fresh Water Tank .....	7-1	LP Gas Tank, Refilling .....	5-2
Fuel Caps, Replacement .....	2-2	LP Gas, Travel with .....	5-3
Fuel Selection, Vehicle .....	2-2	LP Gas, Winter Use of .....	5-4
Fuel Safety Precautions .....	2-2	Lug Bolts, Wheel .....	3-1
Fuel Tank Capacity* .....	2-2, 8-4		
Fuel Tank, Filling Vehicle .....	2-2	<b>M</b>	
Furnace , LP Gas .....	8-7	Maintenance .....	1-4
Fuses, 12-Volt .....	6-7	Microwave Oven .....	8-3
		Mirrors .....	2-6
<b>G</b>		Monitor Panel .....	8-3
Gas Alarm, LP .....	1-3, 5-4	Motor Aid Water Heater .....	8-7
Gas Leaks, LP .....	1-3, 5-4	Mountain Driving .....	4-5
General Warnings .....	1-1		
Generator, Auxiliary 110-Volt .....	6-5	<b>N</b>	
Ground Fault Circuit Interrupter(GFCI) .....	6-4	Nighttime Driving .....	4-5
<b>H</b>		<b>O</b>	
Heater/Defroster .....	2-8	Occupancy, Effects of Prolonged .....	4-6
Heater, Rear Automotive .....	2-7	Owner's InfoCase .....	0-1
Holding Tank, Dumping .....	7-5	Options and Equipment .....	0-1
Holding Tank Level Indicators .....	7-5, 8-4	Outlets, 110-Volt .....	6-5
Humidity and Condensation .....	4-6	Overheated Engine .....	3-2
		Overload Protector, Thermal .....	6-3
<b>I</b>			
If You Get A Flat Tire .....	3-1	<b>P</b>	
Instrument Panel .....	2-7	Pleated Day/Night Shades .....	8-16
Interior Care .....	9-2	Power Converter .....	6-2
		Power Load Center .....	6-2
<b>J</b>		Pre-Travel Checklist .....	4-2
Jump Starting .....	3-3	Preparing Vehicle for Storage .....	10-1
		Pressure Regulator, LP Gas .....	5-3
		Prolonged Occupancy, Effects of .....	4-6

Pump Filter, Shower .....	8-14
Pump Switch, Shower Drain .....	8-13
Pump Switch, Water .....	7-1

**R**

Radio/Cassette Player .....	2-7
Range Top .....	8-3
Range Maintenance .....	9-3
Rear Air Springs (Air Bags) .....	9-7
Rear Auto Air Conditioner (Overhead) .....	2-7
Rear Automotive Heater .....	2-7
Rear Bumper Loads .....	4-2
Rear Window Defogger .....	2-8
Rear Window Washer/Wiper .....	2-9, 9-4
Recovery Towing .....	3-2
Refrigerator - 3-way powered	
Rialta 22FD & 22QD models .....	8-1
Rialta 22HD models .....	8-3
Regulator, LP Gas .....	5-3
Relief Valve, Water Heater .....	8-6
Removal from Storage .....	10-3
Reporting Safety Defects .....	0-2
Restraints, Child .....	2-6
Roof Loading .....	4-2
Roof Maintenance .....	9-1
Roof Vent, Power .....	8-15

**S**

Safe Use of LP Gas System .....	5-1
Safety Defects, Reporting .....	0-2
Sanitizing Water Tank .....	7-2
Seat, Driver .....	2-3
Seat Belts and Child Restraints .....	2-5, 2-6
Seats .....	2-3
Selecting Fuel Types, LP .....	5-2
Service and Assistance .....	0-2
Severe Weather Information .....	4-4
Sewer Hook-Ups, Using On-Site .....	7-6
Shade Adjustment .....	9-4
Shoreline, Connecting the .....	6-1
Shower .....	8-13
Shower Drain Pump System .....	8-13
Shower Drain Strainer .....	8-14
Shower Pump Filter .....	8-14
Shower Valve Pressure Bleed-Off .....	8-14
Signal Amplifier, TV Antenna .....	8-9
Sink, Fold-Up Lavatory .....	8-13
Sink, Stainless Steel .....	9-3
Sleeping Facilities .....	8-10
Smoke Alarm .....	1-7
Spare Tire .....	9-5
Spots and Stains .....	9-2

Start Switch, Aux .....	2-7
Starting and Stopping the Engine .....	2-2
Starting and Stopping the Generator .....	6-5
Storage, Removal from .....	10-3
Storing, Cold Weather .....	10-1
Stripes and Decals .....	9-2
Strainer, Shower Drain .....	8-14
Stripes and Decals, care of .....	9-2
Suspension Alignment and Tire Balance .....	9-6

**T**

Table and Countertop Surfaces .....	9-3
Tank, Fresh Water Filling .....	7-1
Tank Capacities, Water and Holding* .....	8-4
Thermal Overload Protector .....	6-3
Thermostat, Electronic .....	8-7
Tire Balancing .....	9-6
Tire Changing .....	3-2
Tire Pressure and Condition .....	9-5
Tires, Spare .....	3-1
Toilet .....	8-12
Towing, Recovery .....	3-2
Trailer Towing .....	4-2
Trailer Wiring Connector .....	6-9
Travel Tips .....	4-3
Travel with LP Gas .....	5-3
TV Antenna .....	8-8
TV & Cable Hook-Ups, .....	8-10
TV Signal Amplifier .....	8-9

**U**

Underbody Care .....	9-1
Upholstery .....	9-2

**V**

Vehicle Certification Label (VIN) .....	0-4
Vehicle Maintenance .....	9-4
Vents, Power Roof .....	8-15
Vinyl Fabrics .....	9-2
Vinyl Wallboard .....	9-3

**W**

Wallboards, Vinyl .....	9-3
Warnings:	
Carbon Monoxide .....	1-5
Driving .....	1-1
Electrical .....	1-4
Formaldehyde .....	1-5
Fuel & LP Gas .....	1-2
LP Gas Leaks .....	1-2, 5-4
LP Gas Alarm .....	1-3, 5-4
General .....	1-1

---

Generator, Auxiliary .....	6-5
LP Gas .....	1-2
Loading .....	1-4
Maintenance .....	1-4
Warranty .....	0-2
Waste Drainage System .....	7-4
Water and Holding Tank Levels .....	8-4
Water Drain Valves .....	7-3
Water Heater, Motor Aid .....	8-7
Water Heater .....	8-4, 8-6
Water Heater Bypass Valve .....	7-4
Water Heater Capacity* .....	8-4
Water Line Drain Valves .....	7-3
Water Pump .....	7-1
Water Pump Switch .....	7-2
Water Heater Relief Valve .....	8-6
Water Hook-Up, External (City) .....	7-3
Water, Shower Valve Bleed-Off .....	8-15
Water System, Disinfection of .....	7-2
Water System, Fresh .....	7-1
Water Tank, Filling Instructions* .....	7-1
Water Tank Drain Valve Locations .....	7-3
Waxing and Polishing .....	9-1
Weather Information, Service .....	4-4
Weighing the Vehicle .....	4-1
Wheel Mounting Bolts .....	3-1
Wheel Replacement Recommendations .....	9-6
Windows, Cleaning .....	9-3
Windows, Crank-Out .....	8-15
Window, Shades .....	8-16, 9-4
Windows, Emergency Exit .....	1-6
Windshield Wiper/Washer Switch .....	2-9
Winter Use of LP Gas .....	5-4
Winterizing .....	10-1

---



## IMPORTANT SERIAL NUMBERS

Motor Home (Coach): Year \_\_\_\_\_ Model \_\_\_\_\_ Serial \_\_\_\_\_  
Chassis: Make \_\_\_\_\_ Serial (VIN) \_\_\_\_\_

Roof Air Conditioner:	Brand _____	Model _____	Serial _____
Furnace:	Brand _____	Model _____	Serial _____
Water Heater:	Brand _____	Model _____	Serial _____
Power Converter:	Brand _____	Model _____	Serial _____
110-Volt Generator:	Brand _____	Model _____	Serial _____
Range	Brand _____	Model _____	Serial _____
Microwave Oven:	Brand _____	Model _____	Serial _____
Refrigerator	Brand _____	Model _____	Serial _____
Television:	Brand _____	Model _____	Serial _____
Video Cassette Player:	Brand _____	Model _____	Serial _____

## EMERGENCY INFORMATION

### Dealer

Name \_\_\_\_\_

Address \_\_\_\_\_

Phone \_\_\_\_\_

### INSURANCE POLICY

Company \_\_\_\_\_

Policy Number \_\_\_\_\_

Phone \_\_\_\_\_





