

Table of Contents

2004 Rialta 222HD Wiring Diagram Book

Auto Lamps Wiring Diagram
Body, 110 Volt Wiring Diagram
Body, 110 Volt Wiring Installation
Body, 12 Volt Wiring Diagram
Body, 12 Volt Wiring Installation
Dash Radio Installation
Exterior Lamps Wiring Installation
Front End Wiring Installation
Holding Tank Monitor Panel
Holding Tanks Wiring Diagram
TV Coax Wiring Diagram

Electrical Parts Identification List
Wiring Identification Guide

Complete Wiring Diagram Book (701674-73-002)



Copyright © 2003 Winnebago Industries, Inc.



DANGER

Danger of electrical shock, burns or death. Always remove all power sources before attempting any repair, service or diagnostic work. Power can be present from shore power, generator, inverter or battery. All power sources must be disabled and secured before performing any service.



CAUTION

If you lack the skills, tools or equipment to perform diagnostic or repair work leave such work to an authorized Winnebago Industries dealer or other qualified shop.

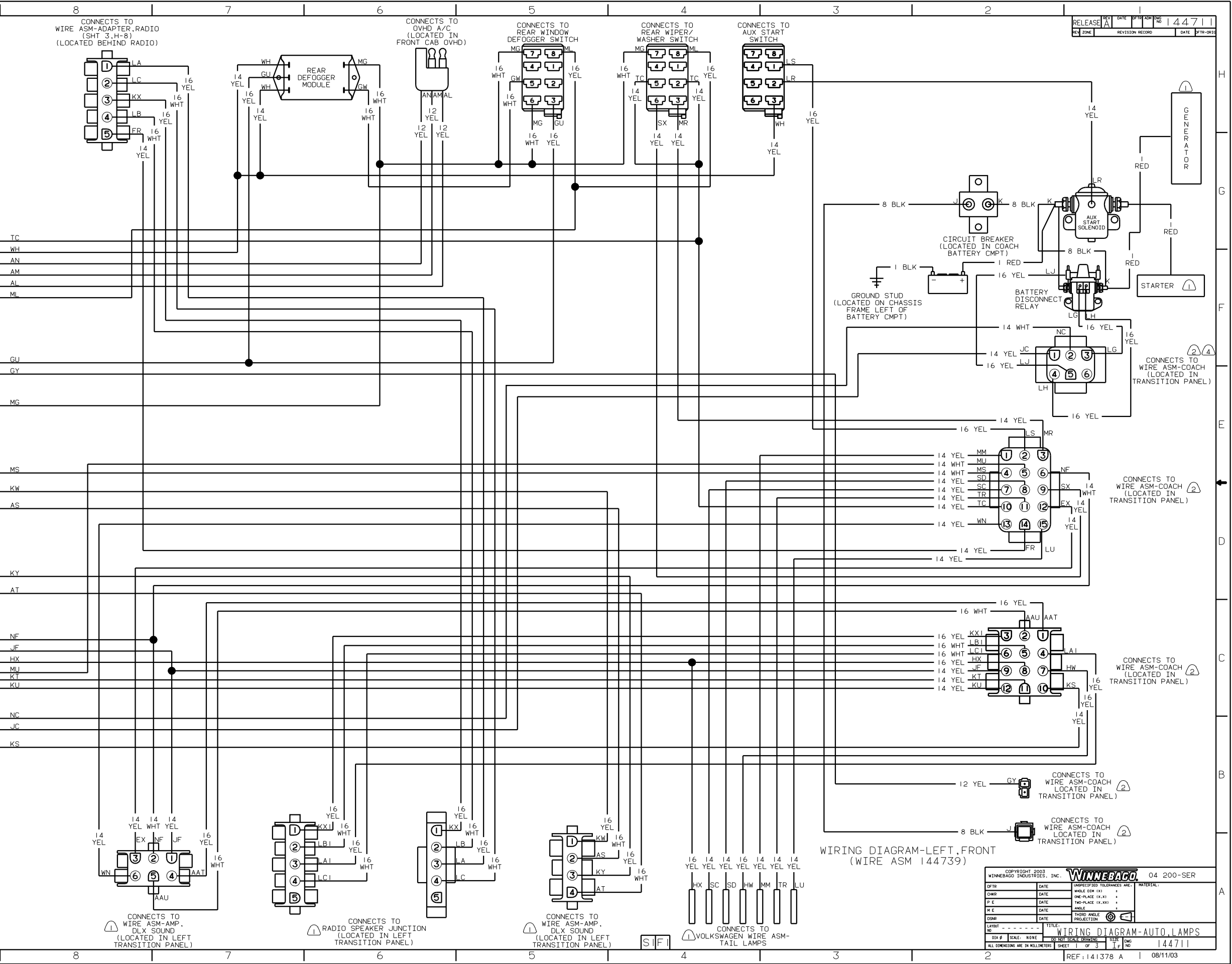

CONNECTS TO WIRE ASM-ADAPTER,RADIO (SHT 3,H-8) (LOCATED BEHIND RADIO)

CONNECTS TO OVHD A/C (LOCATED IN FRONT CAB OVHD)

CONNECTS TO REAR WINDOW DEFOGGER SWITCH

CONNECTS TO REAR WIPER/WASHER SWITCH

CONNECTS TO AUX START SWITCH

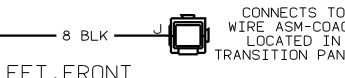
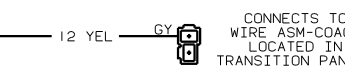
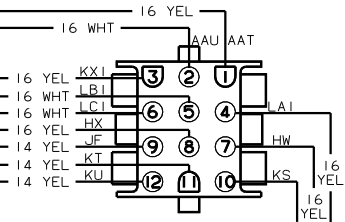
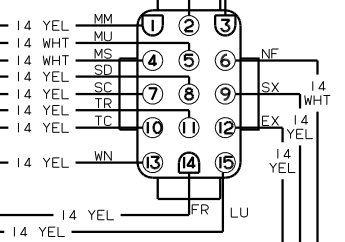
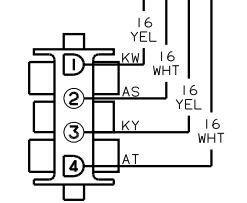
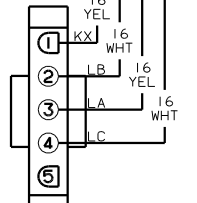
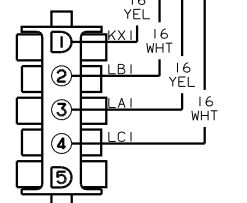
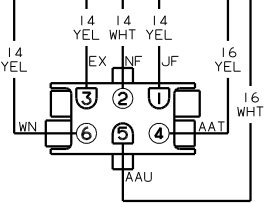
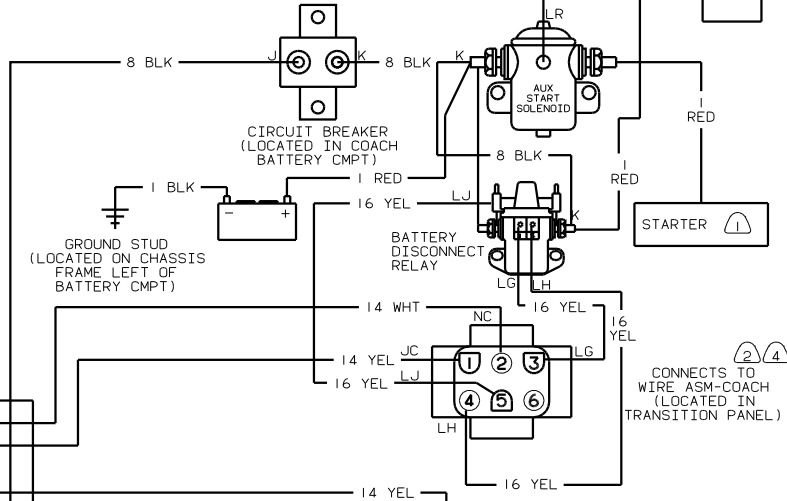
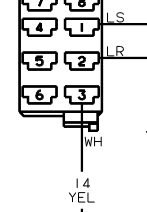
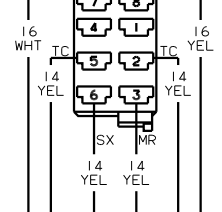
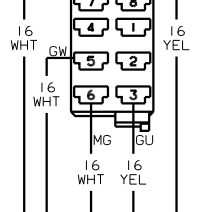
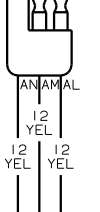
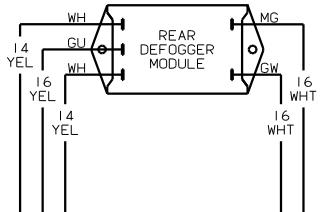
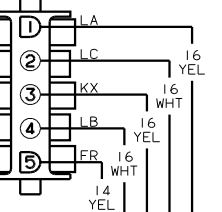

WIRING DIAGRAM-LEFT,FRONT (WIRE ASM 144739)

COPYRIGHT 2003 WINNEBAGO INDUSTRIES, INC. WINNEBAGO 04 200-SER

DATE	DATE	UNSPECIFIED TOLERANCES ARE:	MATERIAL:
DMR	DATE	ANGLE	
P E	DATE	ONE-PLACE (X.X)	
M E	DATE	TWO-PLACE (X.XX)	
DATE	DATE	THIRD ANGLE PROJECTION	

TITLE: WIRING DIAGRAM-AUTO,LAMPS
 DIA # SCALE: NONE DO NOT SCALE DRAWING SIZE: 11 X 17
 ALL DIMENSIONS ARE IN MILLIMETERS SHEET 1 OF 3 DWG NO 144711

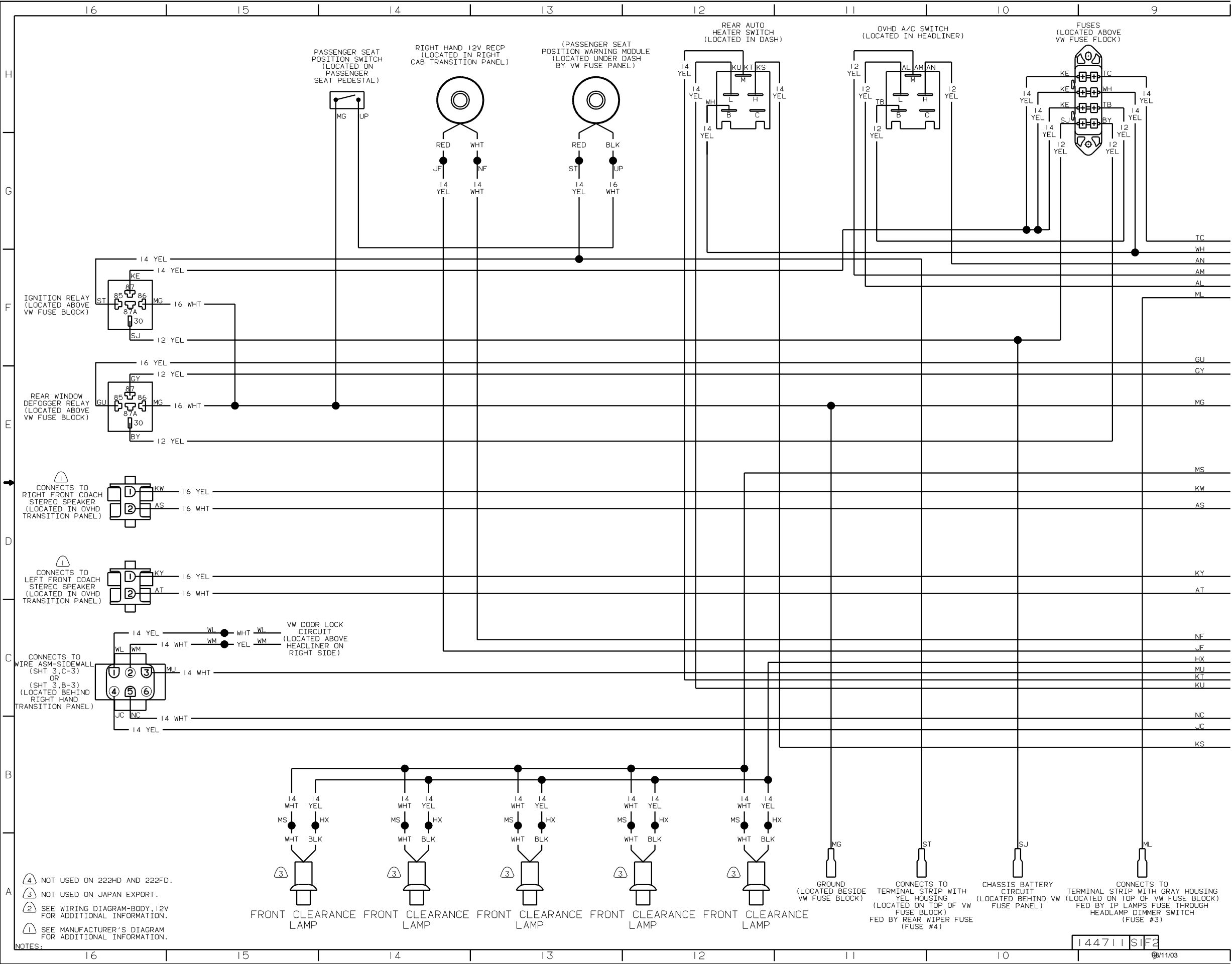

H
 G
 F
 E
 D
 C
 B
 A

16
 15
 14
 13
 12
 11
 10
 9

④ NOT USED ON 222HD AND 222FD.
 ③ NOT USED ON JAPAN EXPORT.
 ② SEE WIRING DIAGRAM-BODY, 12V FOR ADDITIONAL INFORMATION.
 ① SEE MANUFACTURER'S DIAGRAM FOR ADDITIONAL INFORMATION.

NOTES:

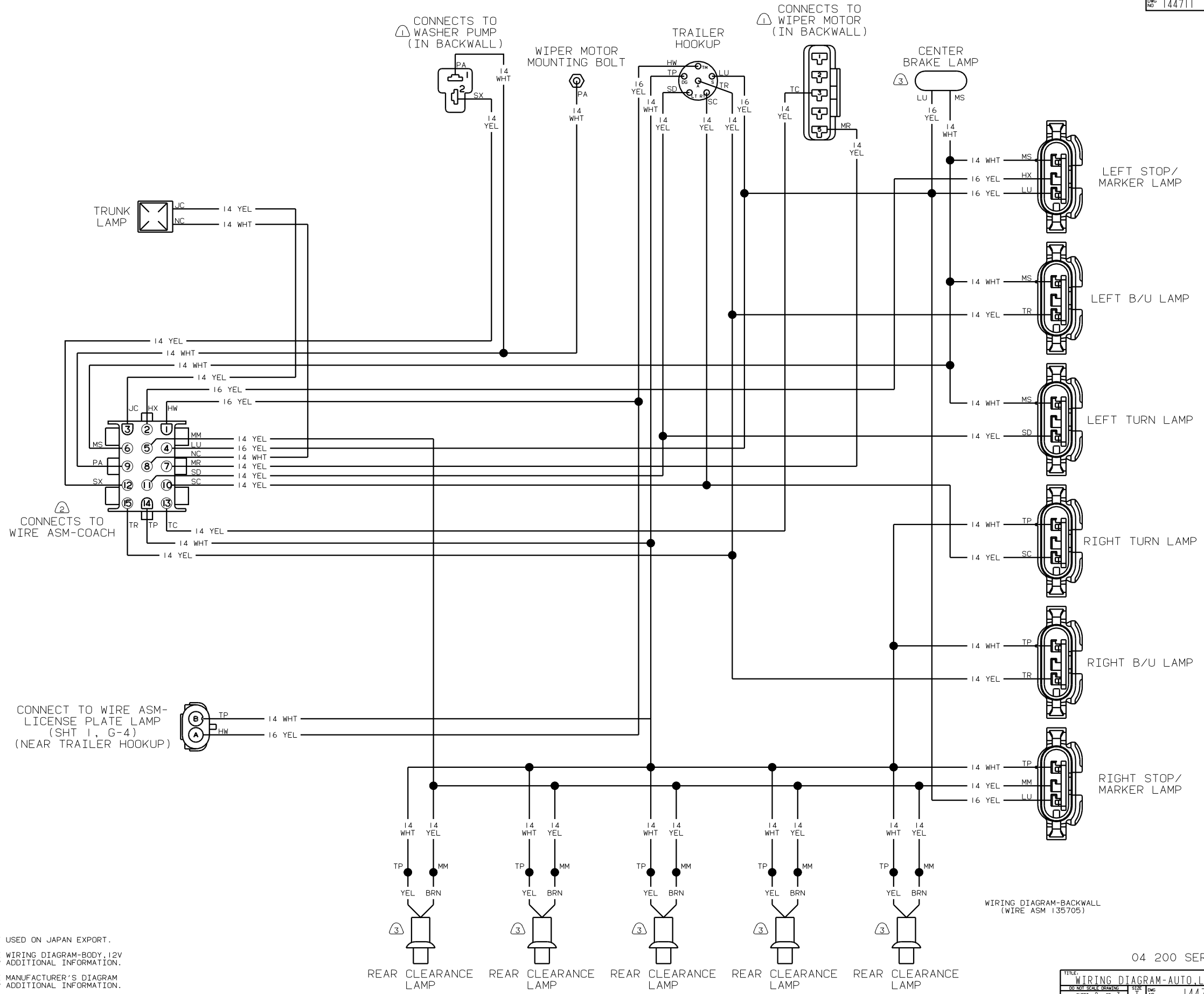

NOTES:
 ③ NOT USED ON JAPAN EXPORT.
 ② SEE WIRING DIAGRAM-BODY, 12V FOR ADDITIONAL INFORMATION.
 ① SEE MANUFACTURER'S DIAGRAM FOR ADDITIONAL INFORMATION.

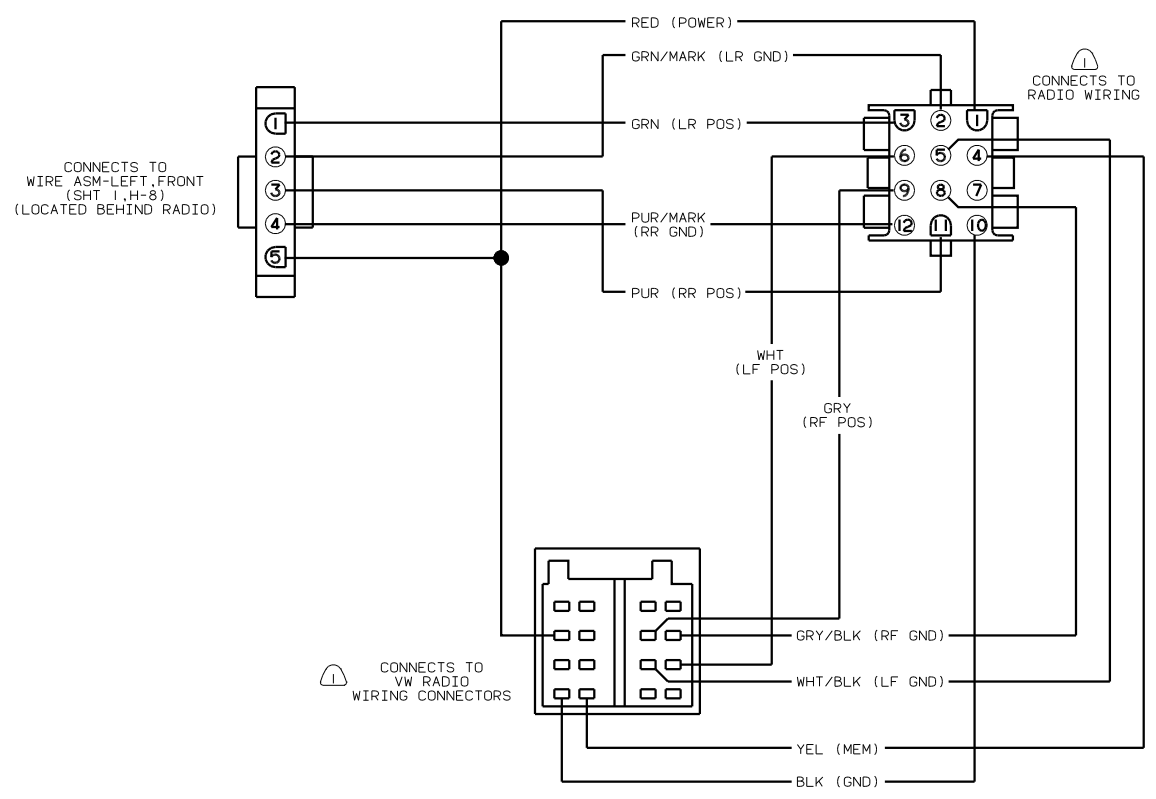

WIRING DIAGRAM-ADAPTER,RADIO
(WIRE ASM 114365-02)

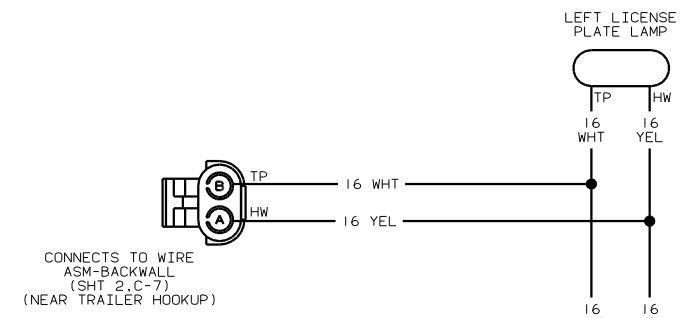

WIRING DIAGRAM LICENSE PLATE LAMPS
(WIRE ASM 113731-02 US/CA)
(WIRE ASM-113731-01 JAPAN EXPORT)

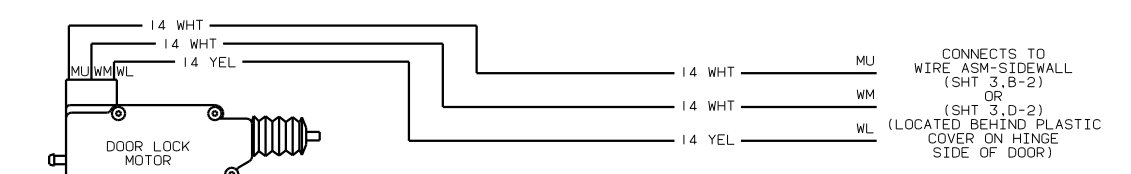

WIRING DIAGRAM-POWER LOCK ENTRANCE
(WIRE ASM 93057-04)

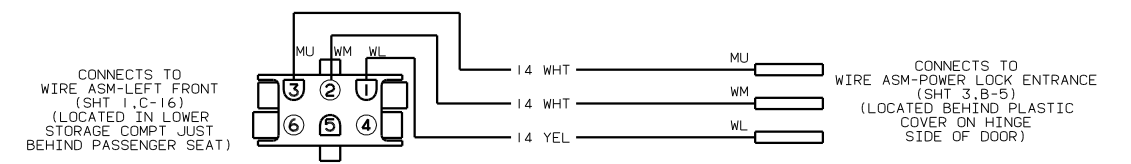

WIRING DIAGRAM-SIDEWALL
(WIRE ASM 135846-01)
222HD & 222FD ONLY

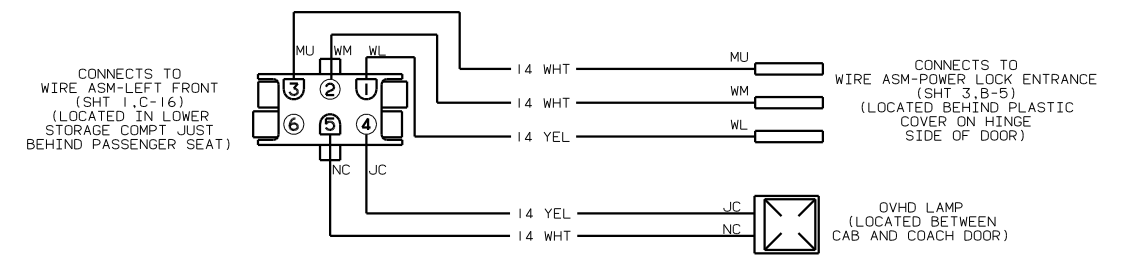

WIRING DIAGRAM-SIDEWALL
(WIRE ASM 135846-02)
222GD ONLY

NOTES:
SEE MANUFACTURER'S DIAGRAM FOR ADDITIONAL INFORMATION.

8 7 6 5 4 3 2

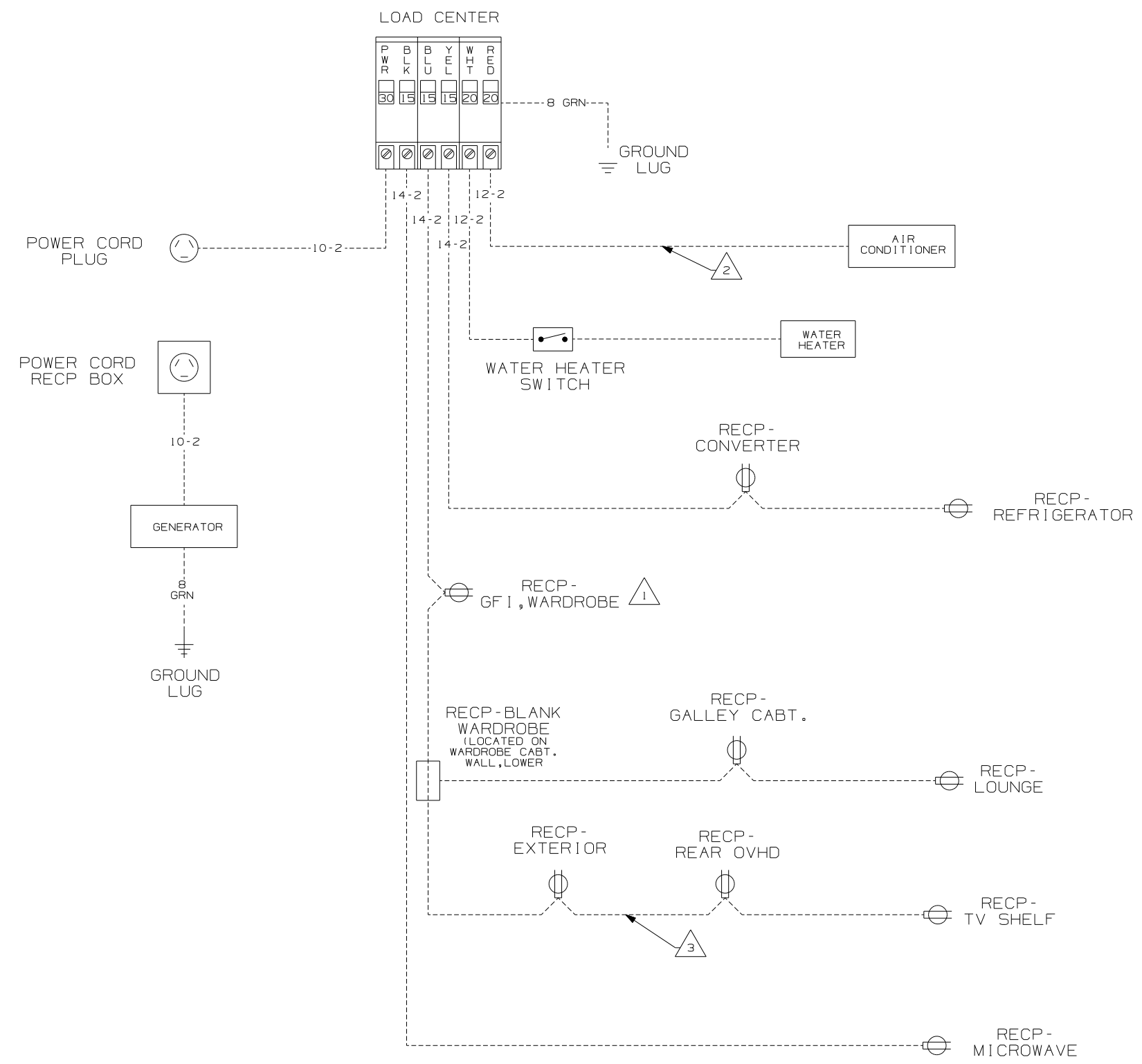

- NOTES:
- 3 WIRE ROUTED THRU SIDEWALL.
 - 2 WIRE ROUTED THRU ROOF.
 - 1 THIS OUTLET AND ALL OUTLETS DOWN STREAM ARE GROUND FAULT CIRCUIT INTERRUPT PROTECTED.

WINNEBAGO		COPYRIGHT 2002 WINNEBAGO INDUSTRIES, INC.	
DFTR	ORIG. DATE	ALL DIMENSIONS ARE IN MILLIMETERS	
CHKR		FIRST USED	
P.E.		04 222HD	
M.E.		UNSPECIFIED TOLERANCES ARE:	
DSNR		MATERIAL:	
		WHOLE DIM (X)	:
		ONE-PLACE (X.X)	:
		TWO-PLACE (X.XX)	:
		ANGLE	:
		THIRD ANGLE PROJECTION	:
DO NOT SCALE DRAWING			
TITLE: WIRING DIAGRAM-BODY, 110V			
SHEET 1 OF 1	PART NO	144799	
REF:141285 A 05/21/03			

8 7 6 5 4 3 2

DWG NO.	FEATURE
144797-01	-----
144797-11	(1B1) (12D)
144797-15	(265) (12D)

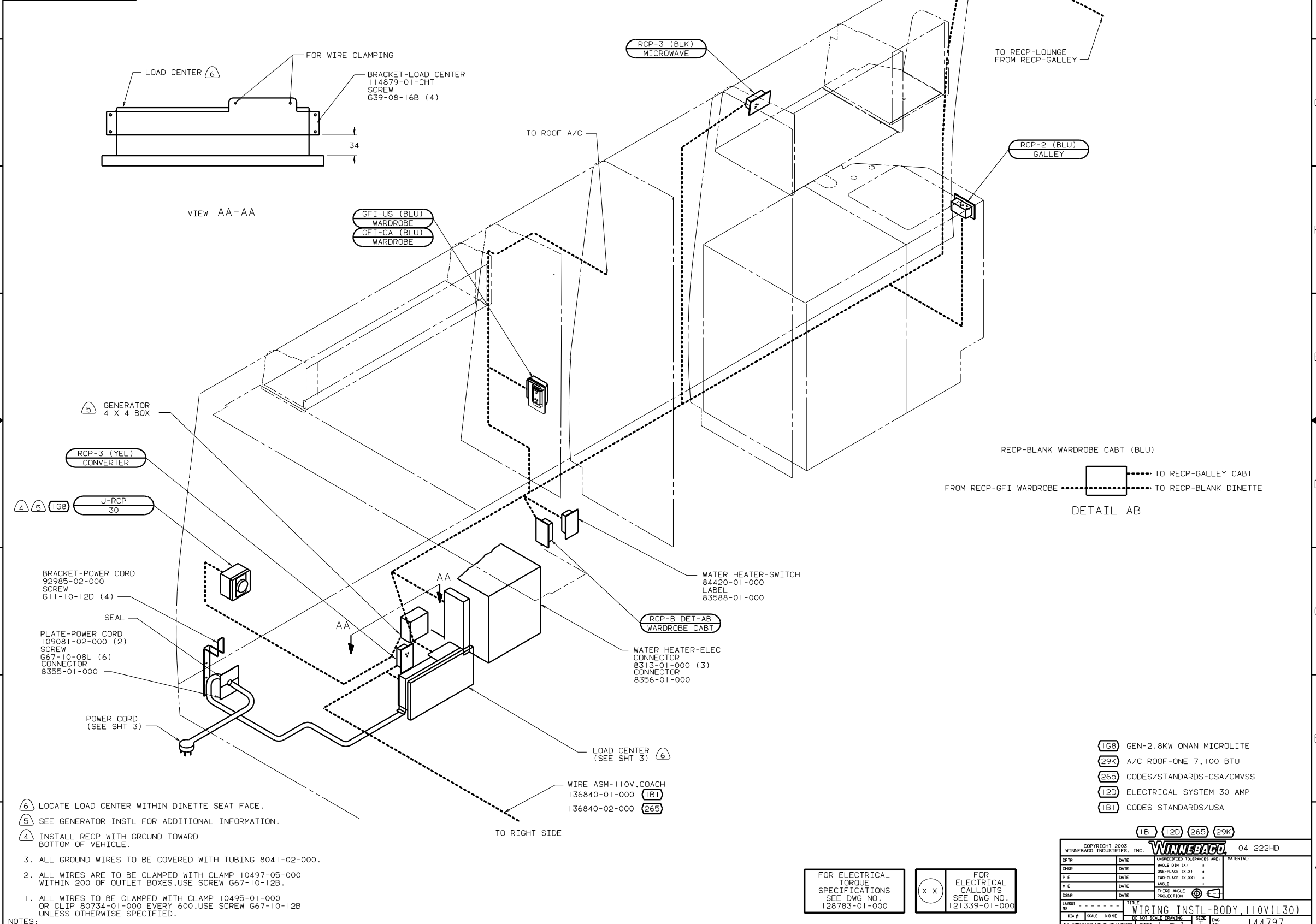

- NOTES:
- LOCATE LOAD CENTER WITHIN DINETTE SEAT FACE.
 - SEE GENERATOR INSTL FOR ADDITIONAL INFORMATION.
 - INSTALL RCP WITH GROUND TOWARD BOTTOM OF VEHICLE.
 - ALL GROUND WIRES TO BE COVERED WITH TUBING 8041-02-000.
 - ALL WIRES ARE TO BE CLAMPED WITH CLAMP 10497-05-000 WITHIN 200 OF OUTLET BOXES, USE SCREW G67-10-12B.
 - ALL WIRES TO BE CLAMPED WITH CLAMP 10495-01-000 OR CLIP 80734-01-000 EVERY 600, USE SCREW G67-10-12B UNLESS OTHERWISE SPECIFIED.

- (1G8) GEN-2.8KW ONAN MICROLITE
- (29K) A/C ROOF-ONE 7,100 BTU
- (265) CODES/STANDARDS-CSA/CMVSS
- (12D) ELECTRICAL SYSTEM 30 AMP
- (1B1) CODES STANDARDS/USA

FOR ELECTRICAL TORQUE SPECIFICATIONS SEE DWG NO. 128783-01-000

(X-X) FOR ELECTRICAL CALLOUTS SEE DWG NO. 121339-01-000

COPYRIGHT 2003 WINNEBAGO INDUSTRIES, INC. **WINNEBAGO** 04 222HD

LAYOUT NO	DATE	UNSPECIFIED TOLERANCES ARE:	MATERIAL:
DWG NO	DATE	WHOLE DIM (XX)	
REV	DATE	ONE-PLACE (X,XX)	
DATE	DATE	TWO-PLACE (X,XX)	
DATE	DATE	ANGLE	
DATE	DATE	THIRD ANGLE PROJECTION	

TITLE: WIRING INSTL-BODY, 110V(L30)

DIA # SCALE: NONE 100 NOT SCALE DRAWING SIZE DWG NO 144797

ALL DIMENSIONS ARE IN MILLIMETERS SHEET 1 OF 3

REF: 141383-A | 08/11/03

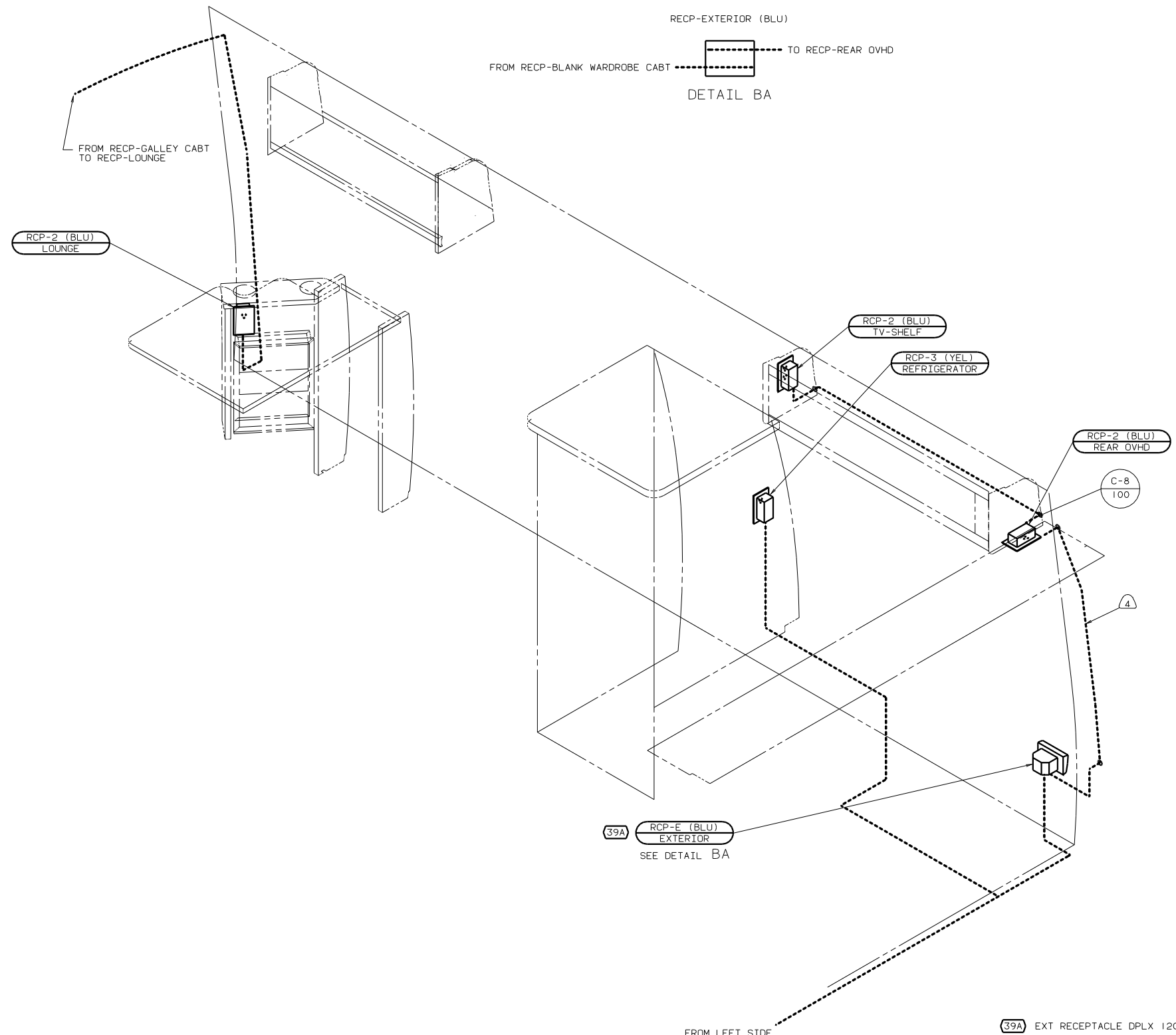

- 4 ROUTE WIRE THRU SIDEWALL.
3. ALL GROUND WIRES TO BE COVERED WITH TUBING 8041-02-000.
2. ALL WIRES ARE TO BE CLAMPED WITH CLAMP 10497-05-000 WITHIN 200 OF OUTLET BOXES, USE SCREW G67-10-12B.
1. ALL WIRES TO BE CLAMPED WITH CLAMP 10495-01-000 OR CLIP 80734-01-000 EVERY 600, USE SCREW G67-10-12B UNLESS OTHERWISE SPECIFIED.

NOTES:

FOR ELECTRICAL TORQUE SPECIFICATIONS SEE DWG NO. 128783-01-000

FOR ELECTRICAL CALLOUTS SEE DWG NO. 121339-01-000

- 39A EXT RECEPTACLE DPLX 120VAC
- 265 CODES/STANDARDS-CSA/CMVSS
- 12D ELECTRICAL SYSTEM 30 AMP
- 1B1 CODES STANDARDS/USA

1B1 12D 265 04 222HD

TITLE: WIRING INSTL-BODY, 110V(R30)
 DWG NO 144797
 SHEET 2 OF 3

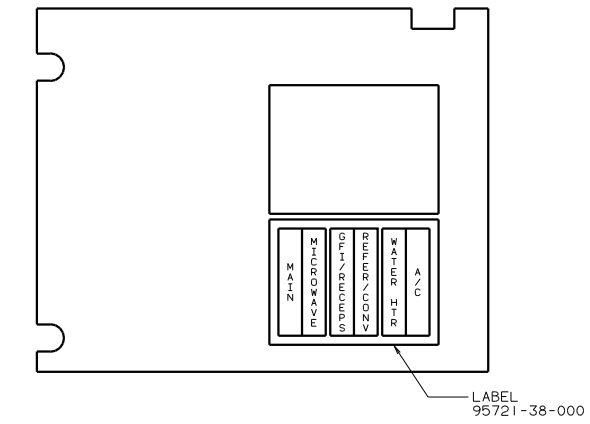
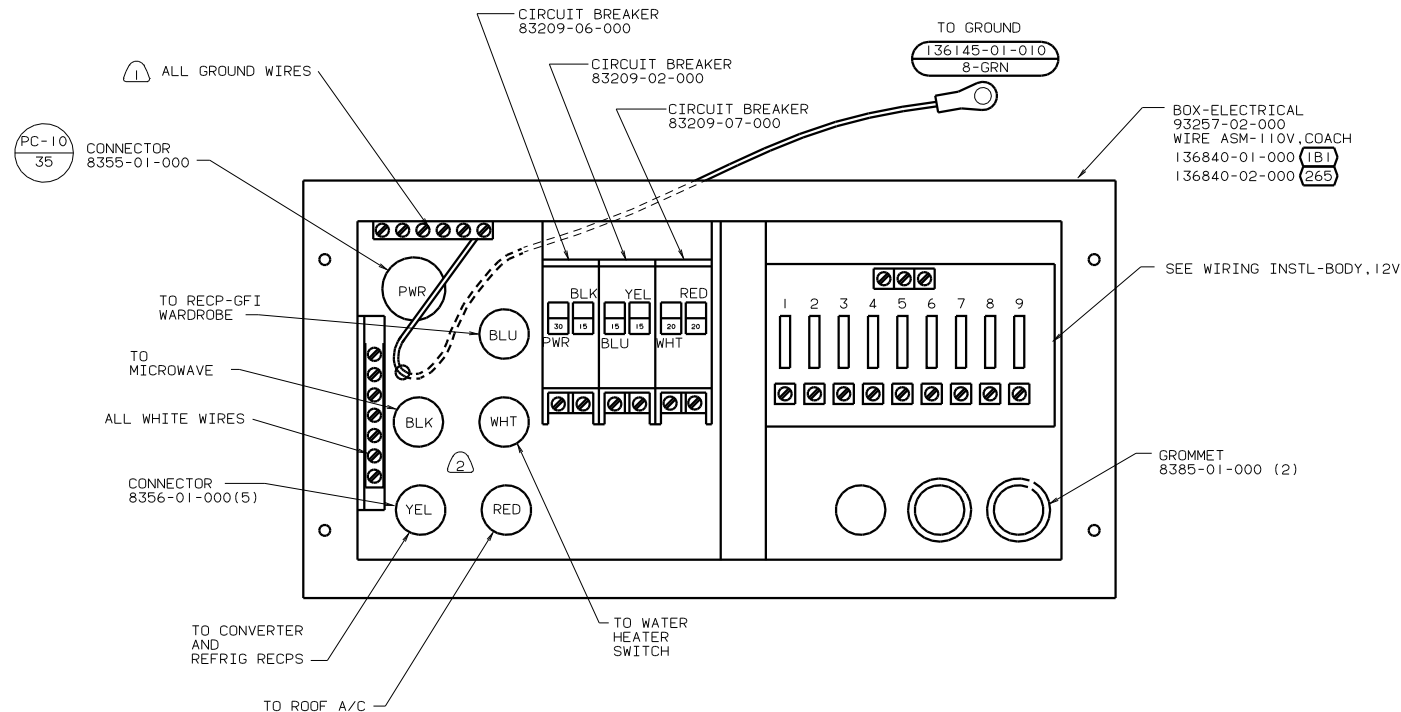

NOTES:
 (2) 110V CABLES IN LOAD CENTER SHALL BE 200 LONG.
 (1) ALL GROUND WIRES TO BE COVERED WITH TUBING 8041-02-000.

FOR ELECTRICAL TORQUE SPECIFICATIONS SEE DWG NO. 128783-01-000

FOR ELECTRICAL CALLOUTS SEE DWG NO. 121339-01-000

(265) CODES/STANDARDS-CSA/CMVSS
 (12D) ELECTRICAL SYSTEM 30 AMP
 (1B1) CODES STANDARDS/USA
 (1B1) (12D) (265) 04 222HD

TITLE: WIRING INSTL-BODY, 110V(LC30)
 DWG No 144797
 SHEET 3 OF 3

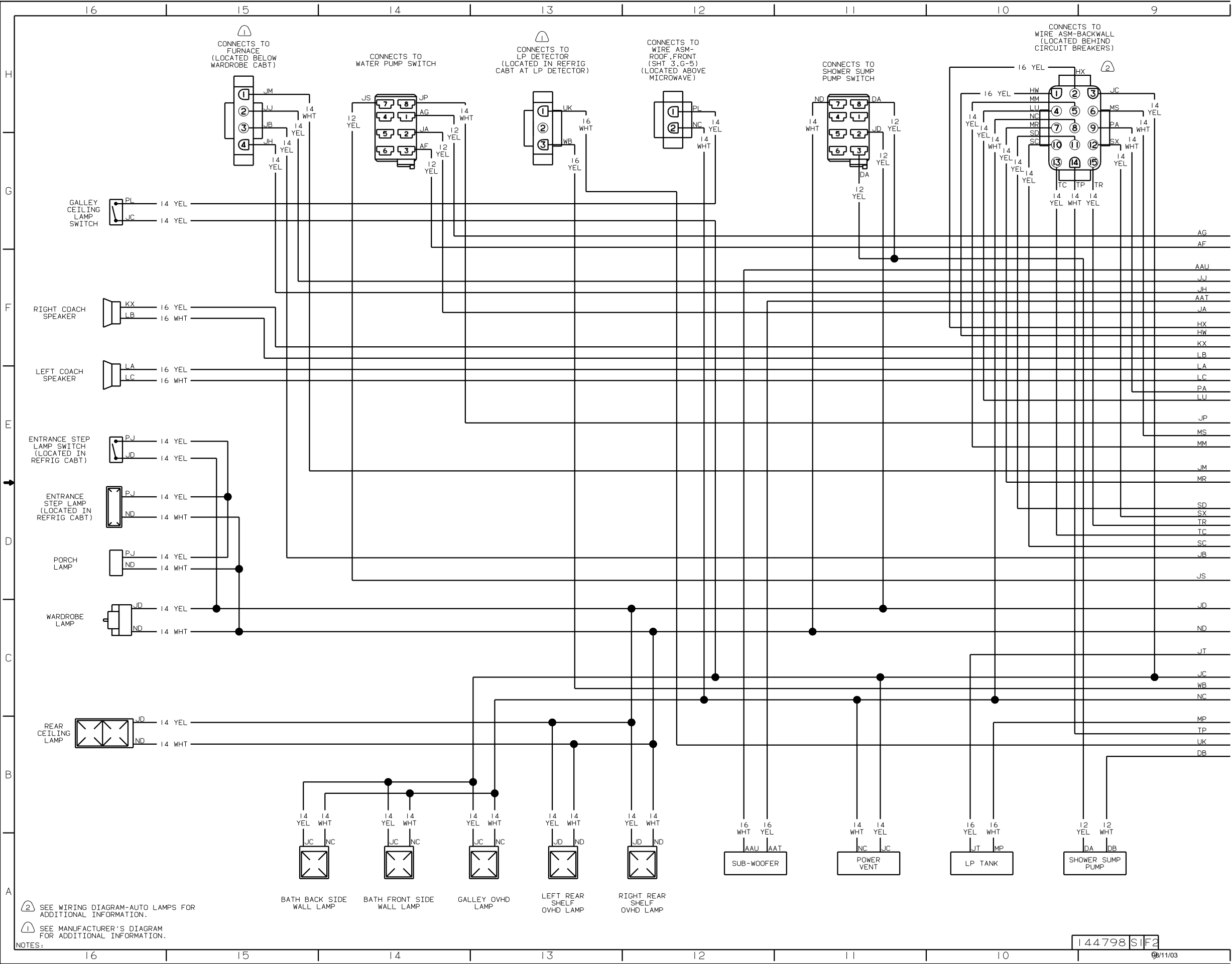

2 SEE WIRING DIAGRAM-AUTO LAMPS FOR ADDITIONAL INFORMATION.
 1 SEE MANUFACTURER'S DIAGRAM FOR ADDITIONAL INFORMATION.

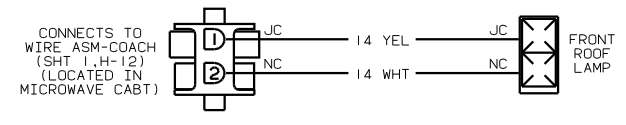

WIRING DIAGRAM-ROOF,FRONT
(WIRE ASM 119112)

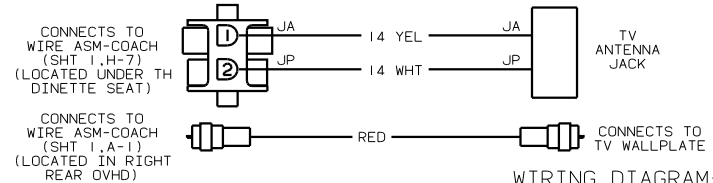

WIRING DIAGRAM-SIDEWALL
(WIRE ASM 111451-03)

DWG NO	SHEET
145057-01	1
145057-02	2
145057-03	3
145057-04	4
145057-05	5
145057-06	6
145057-07	7
145057-08	8

RELEASE	REV DATE	DWG NO	145057
REV ZONE	REVISION RECORD	DATE	DFTR-ORIG

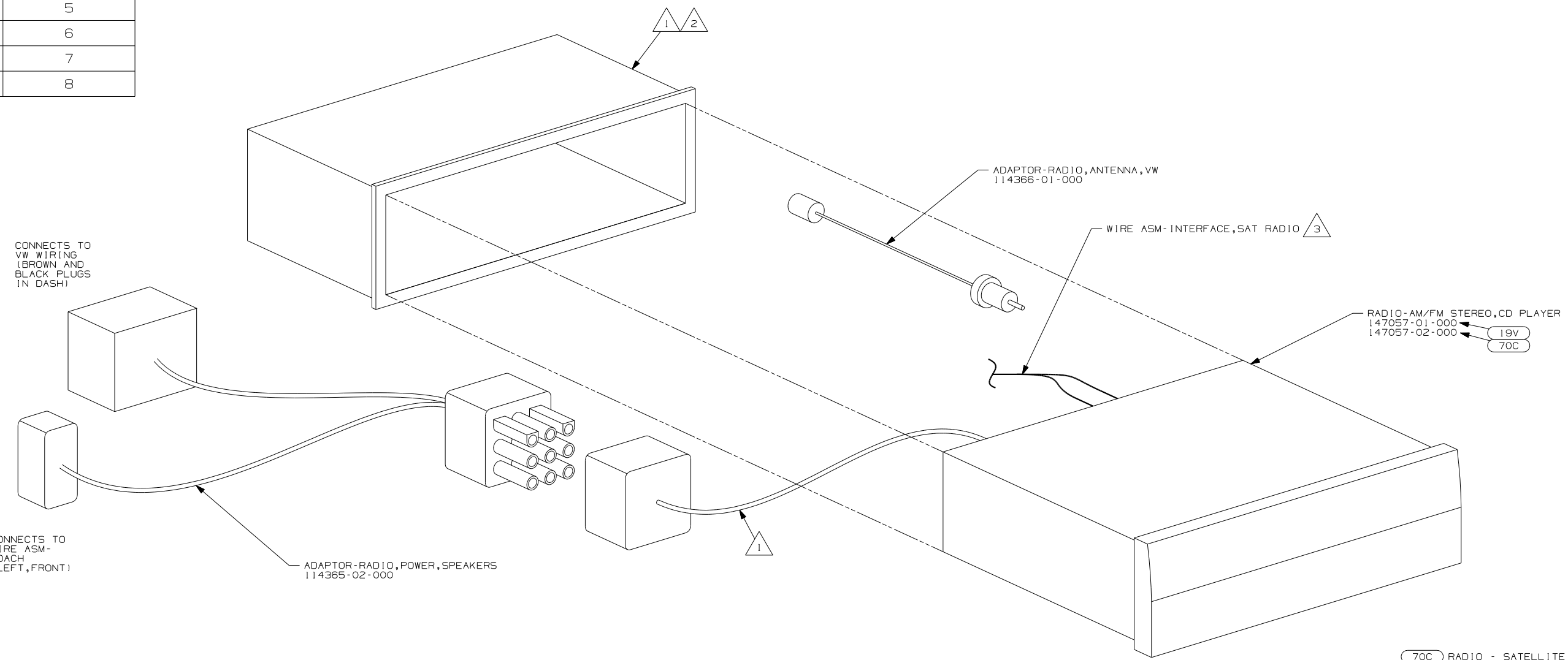

- NOTES:
- △ 3 TO SATELLITE RECEIVER. SEE WIRING INSTL-FRONT END FOR ADDITIONAL INFORMATION.
 - △ 2 BEND TABS ON ALL 4 SIDES TO SECURE MOUNTING BRACKET TO DASH OPENING.
 - △ 1 SUPPLIED WITH RADIO

- 70C RADIO - SATELLITE
- 19V RADIO-AM/FM STEREO CD PLAYER

H-BODY, B-VAN, 200 SERIES

WINNEBAGO COPYRIGHT 2004 WINNEBAGO INDUSTRIES, INC.

DFTR	ORIG. DATE
CHKR	ALL DIMENSIONS ARE IN MILLIMETERS
P.E.	
M.E.	FIRST USED
DSNR	04 MOTORHOMES

UNSPECIFIED TOLERANCES ARE: MATERIAL:

WHOLE DIM (X) :
ONE-PLACE (X.X) :
TWO-PLACE (X.XX) :
ANGLE :

THIRD ANGLE PROJECTION

DO NOT SCALE DRAWING

TITLE: RADIO INSTL

SHEET 1 OF 8 PART NO 145057

REF:141321-E 1/17/2004

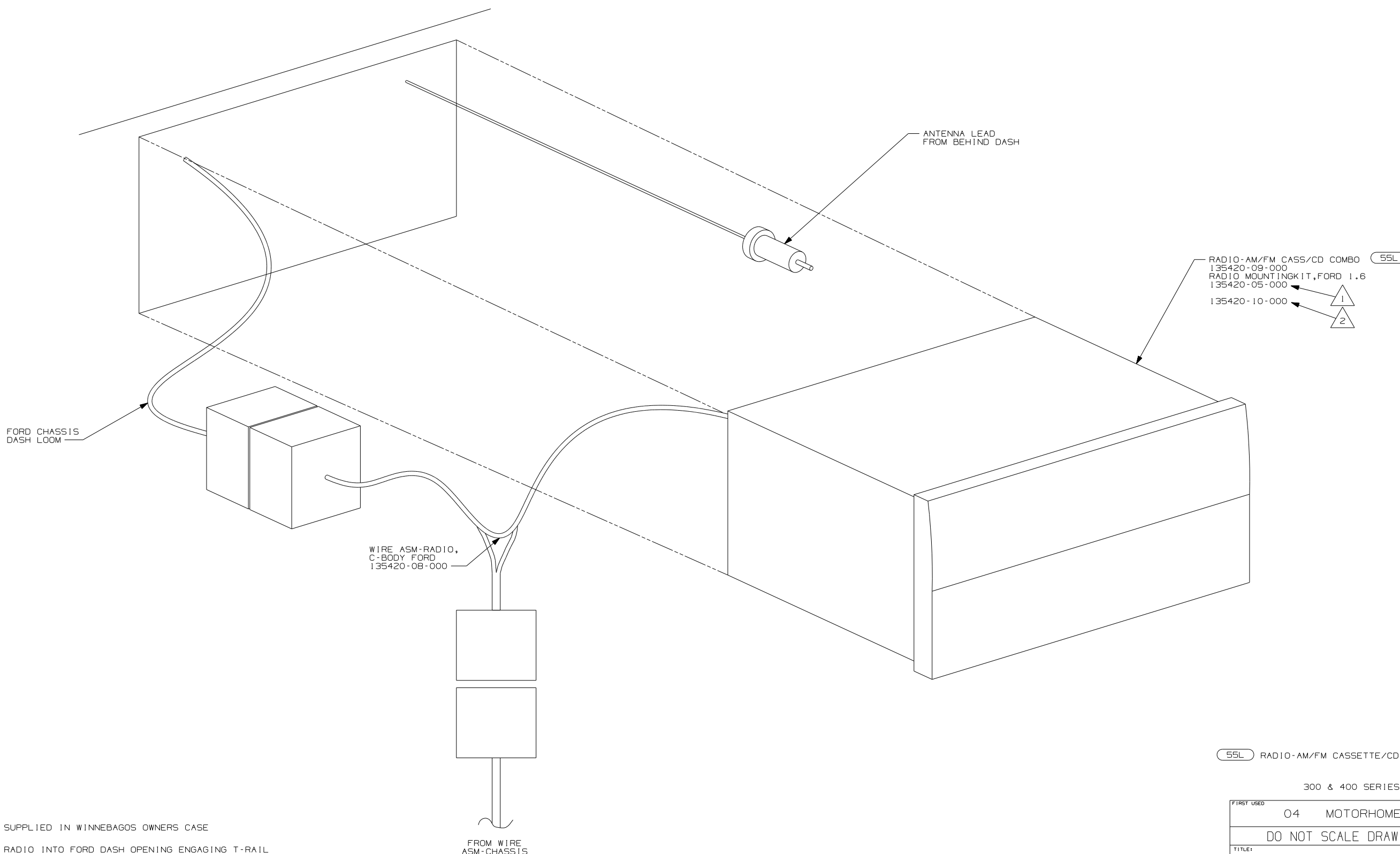

- 55L RADIO-AM/FM CASSETTE/CD
- 135420-09-000
- 135420-05-000
- 135420-10-000

FORD CHASSIS DASH LOOM

WIRE ASM-RADIO, C-BODY FORD 135420-08-000

ANTENNA LEAD FROM BEHIND DASH

FROM WIRE ASM-CHASSIS

55L RADIO-AM/FM CASSETTE/CD

300 & 400 SERIES

- NOTES:
- 2 TO BE SUPPLIED IN WINNEBAGOS OWNERS CASE
 - 1 SLIDE RADIO INTO FORD DASH OPENING ENGAGING T-RAIL ON BOTTOM OF RADIO UNTIL LOCKED IN PLACE.

FIRST USED	04 MOTORHOMES
DO NOT SCALE DRAWING	
TITLE:	RADIO INSTL
SHEET 2	PART NO 145057

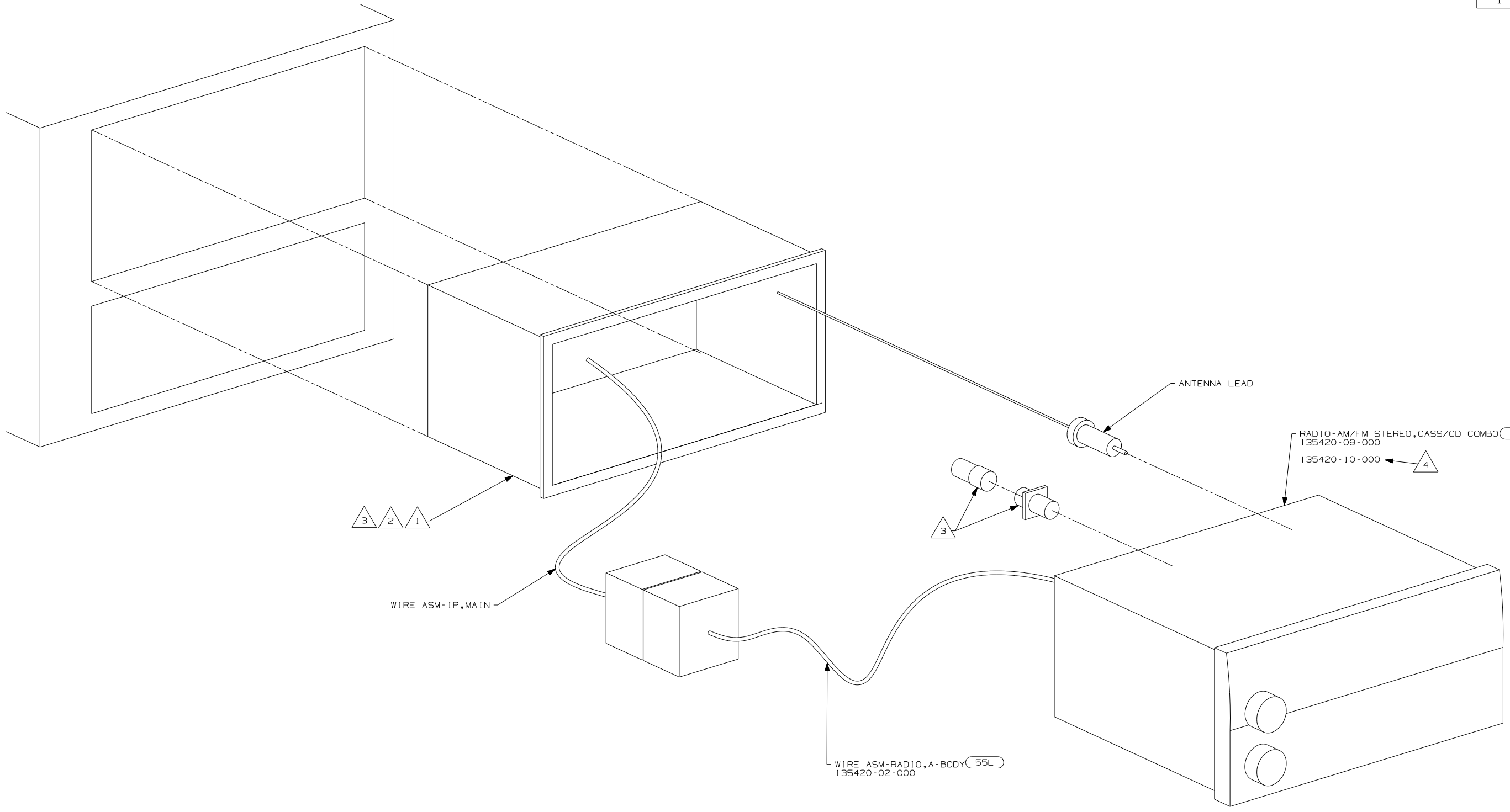

3 2 1

WIRE ASM-IP,MAIN

WIRE ASM-RADIO,A-BODY 55L
135420-02-000

ANTENNA LEAD

RADIO-AM/FM STEREO,CASS/CD COMBO 55L
135420-09-000
135420-10-000 4

- NOTES:
- 4 TO BE SUPPLIED IN WINNEBAGOS OWNERS CASE
 - 3 SUPPLIED WITH MOUNTING KIT 135420-07-000 55L ONLY.
 - 2 BEND TABS ON ALL 4 SIDES TO SECURE MOUNTING BRACKET TO DASH OPENING.
 - 1 SUPPLIED WITH RADIO 24N ONLY.

55L RADIO-AM/FM CASSETTE/CD
D SERIES

FIRST USED	04 MOTORHOMES
TITLE	DO NOT SCALE DRAWING
SHEET 3	PART NO 145057

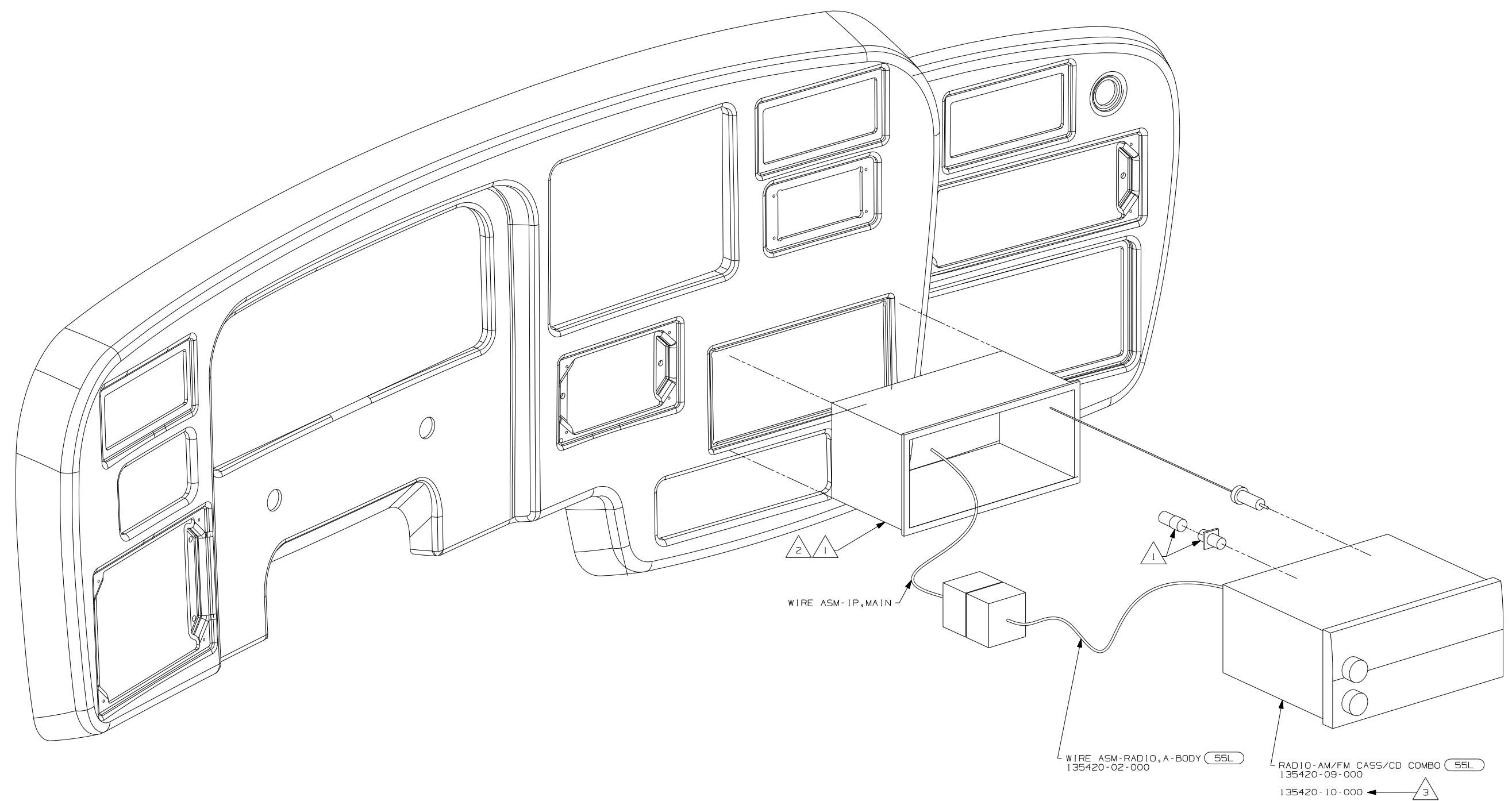

- NOTES:
- 3 TO BE SUPPLIED IN WINNEBAGOS OWNERS CASE
 - 2 BEND TABS ON ALL 4 SIDES TO SECURE MOUNTING BRACKET TO DASH OPENING.
 - 1 SUPPLIED WITH MOUNTING KIT 135420-07-000.

- 52T CD CHANGER-10 DISC
 - 55L RADIO-AM/FM CASSETTE/CD
- F & G SERIES

FIRST USED	
04 MOTORHOMES	
DO NOT SCALE DRAWING	
TITLE:	
RADIO INSTL	
SHEET 4	PART NO
	145057

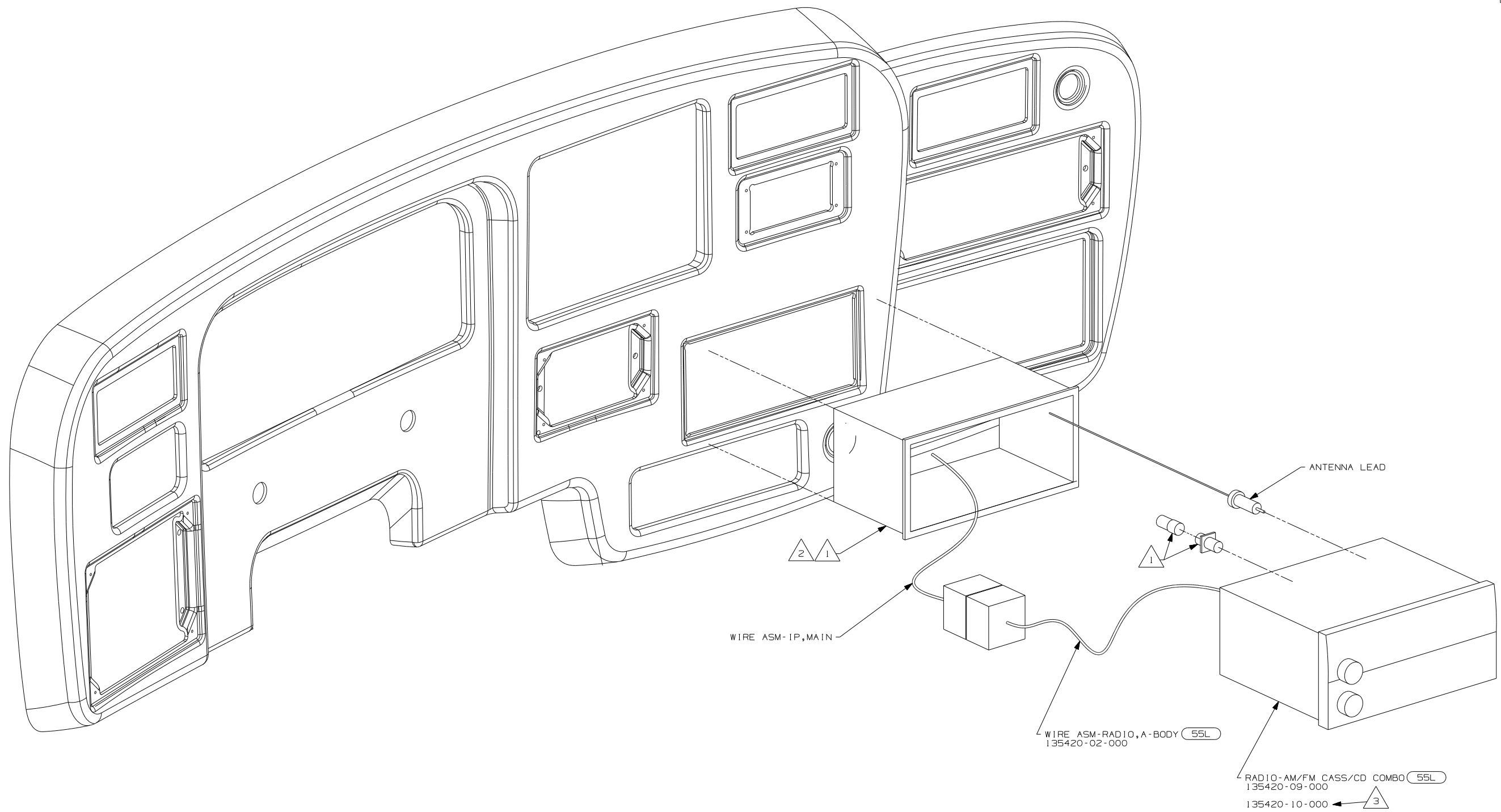

- NOTES:
- 3 TO BE SUPPLIED IN WINNEBAGOS OWNERS CASE
 - 2 BEND TABS ON ALL 4 SIDES TO SECURE MOUNTING BRACKET TO DASH OPENING.
 - 1 SUPPLIED WITH MOUNTING KIT 135420-07-000.

- 52T CD CHANGER-10 DISC
 - 55L RADIO-AM/FM CASSETTE/CD
- L SERIES

FIRST USED	04 MOTORHOMES
TITLE	RADIO INSTL
SHEET 5	PART NO 145057

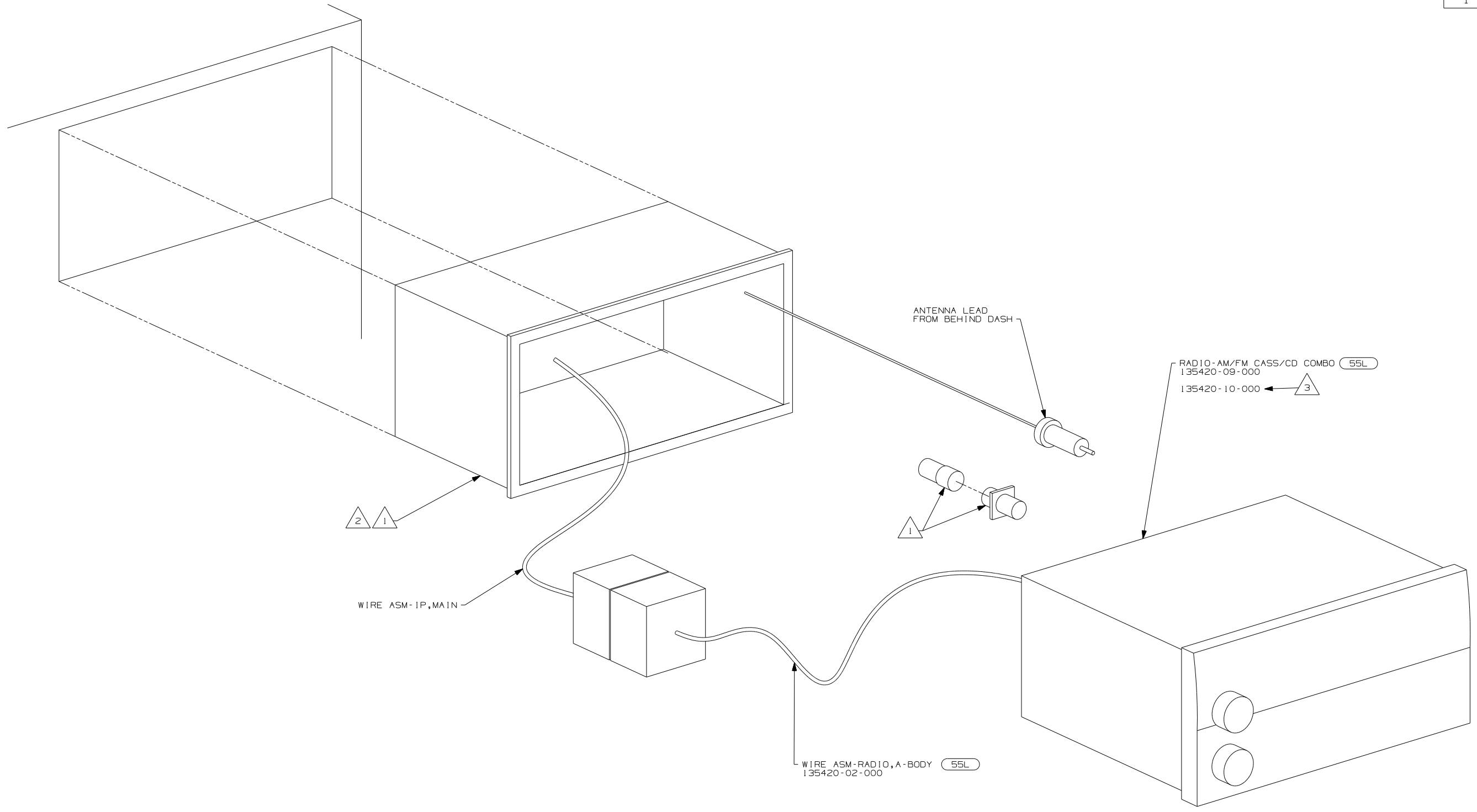

RADIO-AM/FM CASS/CD COMBO (55L)
 135420-09-000
 135420-10-000 ← 3

WIRE ASM-RADIO,A-BODY (55L)
 135420-02-000

WIRE ASM-IP,MAIN

ANTENNA LEAD FROM BEHIND DASH

(52T) CD CHANGER-10 DISC
 (55L) RADIO-AM/FM CASSETTE/CD

P SERIES

FIRST USED	04 MOTORHOMES
TITLE	DO NOT SCALE DRAWING
SHEET 6	PART NO 145057

- NOTES:
- 3 TO BE SUPPLIED IN WINNEBAGOS OWNERS CASE
 - 2 BEND TABS ON ALL 4 SIDES TO SECURE MOUNTING BRACKET TO DASH OPENING.
 - 1 SUPPLIED WITH MOUNTING KIT 135420-07-000.

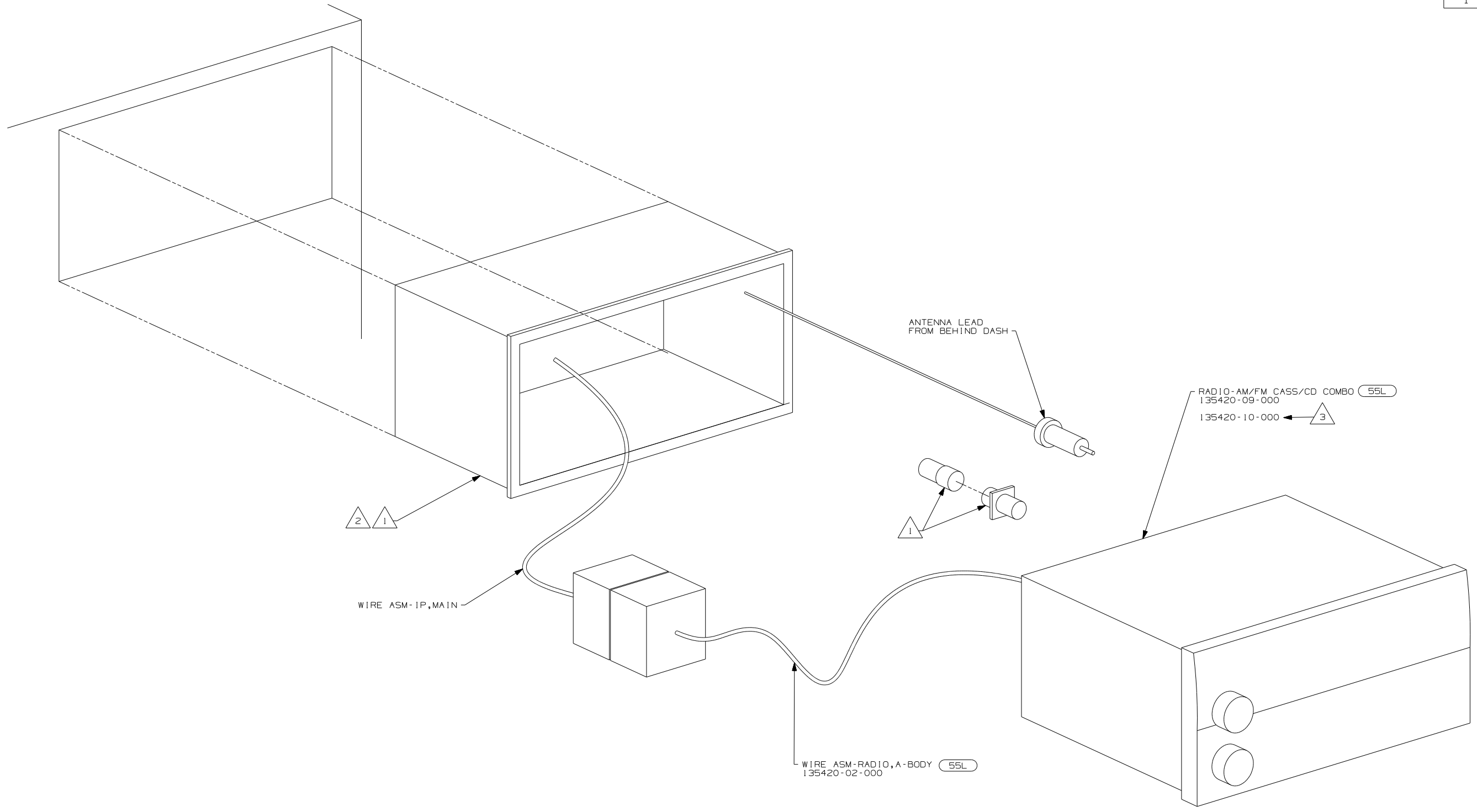

RADIO-AM/FM CASS/CD COMBO (55L)
 135420-09-000
 135420-10-000 ← 3

ANTENNA LEAD
 FROM BEHIND DASH

2 1

WIRE ASM-IP,MAIN

WIRE ASM-RADIO,A-BODY (55L)
 135420-02-000

- (52T) CD CHANGER-10 DISC
- (55L) RADIO-AM/FM CASSETTE/CD

S SERIES

- NOTES:
- 3 TO BE SUPPLIED IN WINNEBAGOS OWNERS CASE
 - 2 BEND TABS ON ALL 4 SIDES TO SECURE MOUNTING BRACKET TO DASH OPENING.
 - 1 SUPPLIED WITH MOUNTING KIT 135420-07-000.

FIRST USED	
04 MOTORHOMES	
DO NOT SCALE DRAWING	
TITLE	
RADIO INSTL	
SHEET 7	PART NO 145057

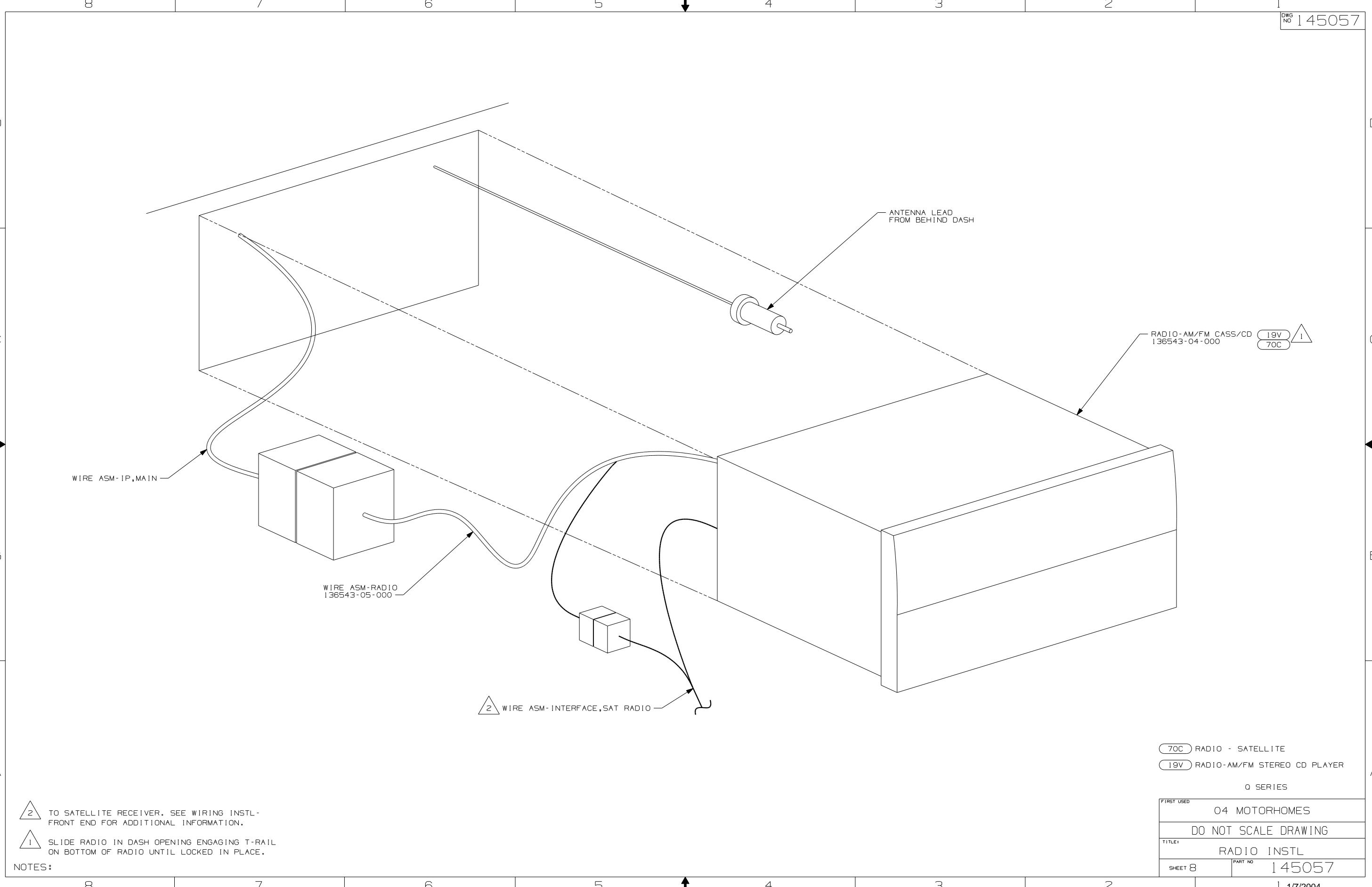

WIRE ASM-IP,MAIN

WIRE ASM-RADIO
136543-05-000

2 WIRE ASM-INTERFACE,SAT RADIO

ANTENNA LEAD
FROM BEHIND DASH

RADIO-AM/FM CASS/CD
136543-04-000

19V
70C

2 TO SATELLITE RECEIVER. SEE WIRING INSTL-FRONT END FOR ADDITIONAL INFORMATION.

1 SLIDE RADIO IN DASH OPENING ENGAGING T-RAIL ON BOTTOM OF RADIO UNTIL LOCKED IN PLACE.

NOTES:

70C RADIO - SATELLITE
19V RADIO-AM/FM STEREO CD PLAYER

0 SERIES

FIRST USED	04 MOTORHOMES
TITLE	DO NOT SCALE DRAWING
SHEET 8	PART NO 145057
	1 1/7/2004

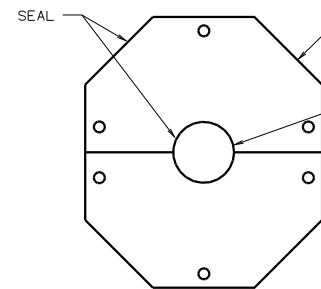

VIEW AA-AA

PLATE
109081-02-000 (2)
SCREW
G11-08-16U (6)

GROMMET
71015-18-000

3 WIRE ASM-LEFT, FRONT

LAMP-CLEARANCE, AMBER 5
113709-01-000 (5)
SCREW
G11-08-12T (10)
CONNECTOR
58028-01-000 (10)

3 TO VOLKSWAGEN
WIRE ASM-
TAIL LAMPS

WIRE ASM-COACH

2 LAMP-CLEARANCE, RED
111102-01-000 (5)
LAMP-MARKER, LENS, RED
111102-03-000 (5)
SCREW
G39-08-12U (EXT) (10)

4 LAMP ASM-CENTER BRAKE
136916-01-000
SCREW
G11-08-20T (2)
BLK/WHT - YEL
BLK - WHT

LF1-1

TO WIPER MOTOR
5 PIN HOUSING

WIRE ASM-BACKWALL
135705-01-000

TO WASHER PUMP
2 PIN HOUSING

TO WIRE ASM-
LICENSE PLATE LAMP
2 PIN HOUSING

CONNECTOR-SOCKET, TRAILER
SCREW
101618-01-000 (2)

LAMP ASM
112126-03-000 (RH)
112126-04-000 (LH)
112126-05-000 (RH)
112126-06-000 (LH) } 27A
SOCKET-LAMP
112709-01-000 (2)
112709-02-000 (2)
112709-03-000 (2)
BULB
112707-01-000 (4)
112708-01-000 (2)
BRACKET ASM-TAIL LAMP
113778-03-000 (2)
SCREW
G39-10-209 (4)
GROMMET
23942-01-000 (2)

LEX 2UL LEX 2CA 6 7
SEE DETAIL AB
FOR WIRING
CONNECTIONS

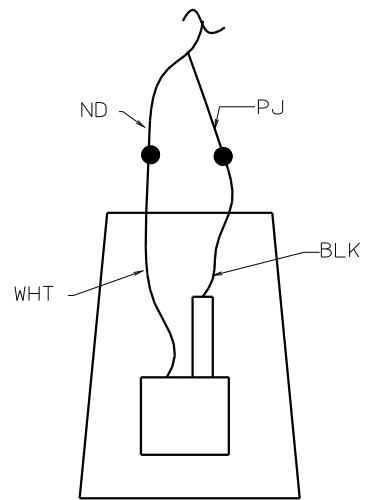

DETAIL AB

27A EXT FULL BODY PAINT PKG #1

- 7 INSTALL WITH WIRE TOWARD ROOF.
- 6 NOT USED ON THE 222S.
- 5 CONNECT WIRE HX (YEL) TO RED WIRE AND WIRE MS (WHT) TO WHT WIRE.
- 4 ON INTERIOR OF CAP, GRIND OFF TIP OF SCREW PRIOR TO SEALING (TO PROVIDE INNER LINER CLEARANCE).
- 3 SEE WIRING INSTL-FRONT END FOR ADDITIONAL INFORMATION.
- 2 LOCATE ON CENTER OF HOLE IN CAP ASM-REAR.

1. CONNECTOR-PLUG, TRAILER 113589-01-000 TO BE SUPPLIED LOOSE IN COACH WITH TRAILER TOW PACKAGE.

NOTES:

X-X FOR ELECTRICAL CALLOUTS SEE DWG NO. 121339-01-000

FOR ELECTRICAL TORQUE SPECIFICATIONS SEE DWG NO. 128783-01-000

COPYRIGHT 2003 WINNEBAGO INDUSTRIES, INC. WINNEBAGO 04 200 SERIES	
DATE	UNSPECIFIED TOLERANCES ARE:
DATE	WHOLE DIM (XX) ±
DATE	ONE-PLACE (X.X) ±
DATE	TWO-PLACE (X.XX) ±
DATE	ANGLE
DATE	THIRD ANGLE PROJECTION
LAYOUT NO.	TITLE: WIRING INSTL-EXTERIOR LAMPS
DIA #	SCALE: NONE
DO NOT SCALE DIMENSIONS	SHEET NO. 144709
ALL DIMENSIONS ARE IN MILLIMETERS	REF: 141399 A 08/11/03

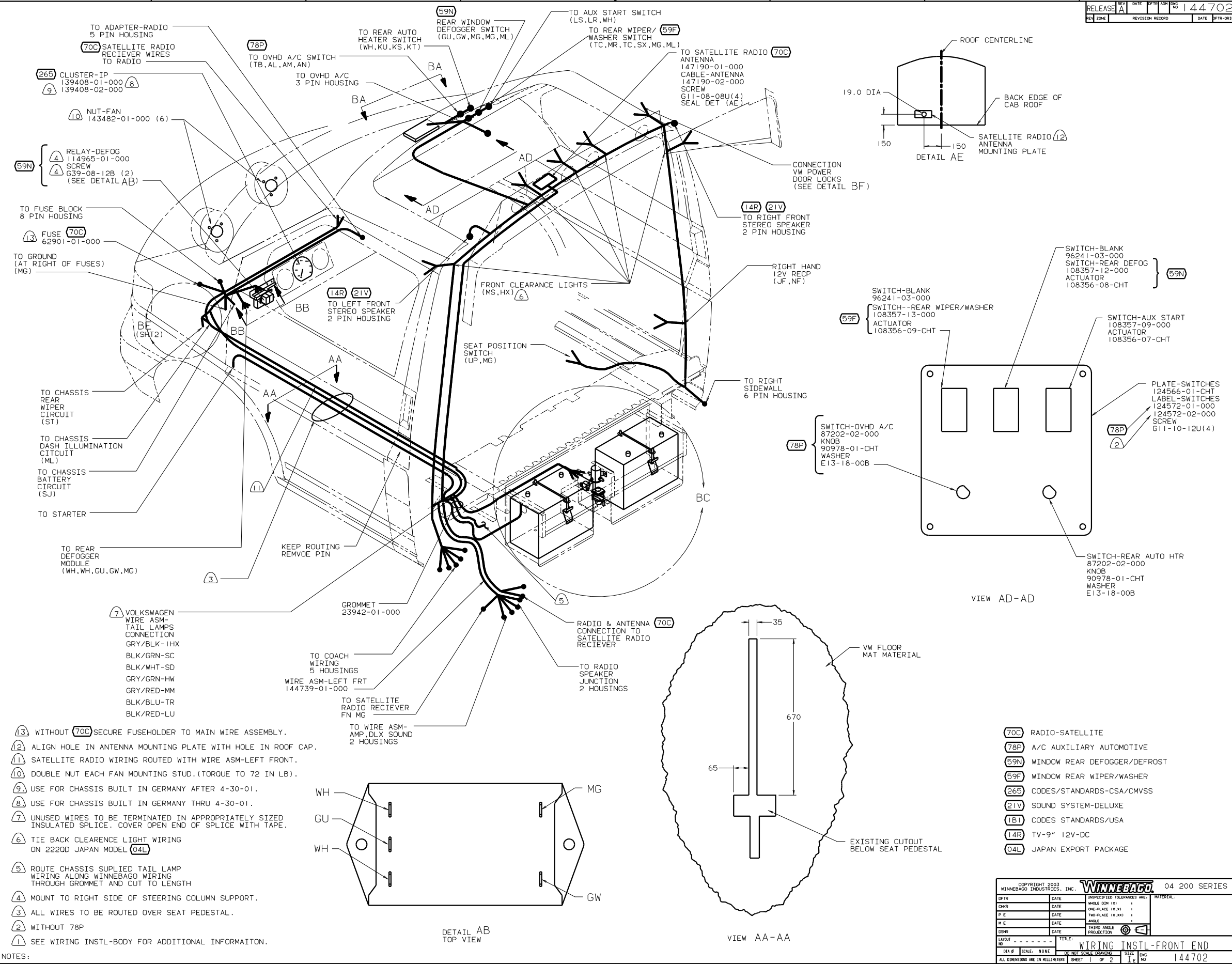

- 13 WITHOUT 70C SECURE FUSEHOLDER TO MAIN WIRE ASSEMBLY.
- 12 ALIGN HOLE IN ANTENNA MOUNTING PLATE WITH HOLE IN ROOF CAP.
- 11 SATTELITE RADIO WIRING ROUTED WITH WIRE ASM-LEFT FRONT.
- 10 DOUBLE NUT EACH FAN MOUNTING STUD. (TORQUE TO 72 IN LB).
- 9 USE FOR CHASSIS BUILT IN GERMANY AFTER 4-30-01.
- 8 USE FOR CHASSIS BUILT IN GERMANY THRU 4-30-01.
- 7 UNUSED WIRES TO BE TERMINATED IN APPROPRIATELY SIZED INSULATED SPLICE. COVER OPEN END OF SPLICE WITH TAPE.
- 6 TIE BACK CLEARENCE LIGHT WIRING ON 2220D JAPAN MODEL 04L
- 5 ROUTE CHASSIS SUPPLIED TAIL LAMP WIRING ALONG WINNEBAGO WIRING THROUGH GROMMET AND CUT TO LENGTH
- 4 MOUNT TO RIGHT SIDE OF STEERING COLUMN SUPPORT.
- 3 ALL WIRES TO BE ROUTED OVER SEAT PEDESTAL.
- 2 WITHOUT 78P
- 1 SEE WIRING INSTL-BODY FOR ADDITIONAL INFORMAITON.

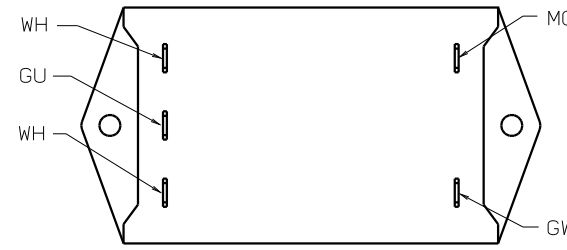

DETAIL AB
TOP VIEW

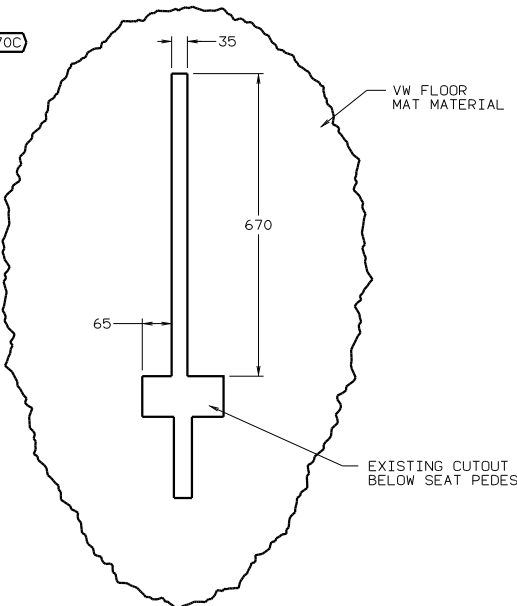

VIEW AA-AA

- 70C RADIO-SATELLITE
- 78P A/C AUXILIARY AUTOMOTIVE
- 59N WINDOW REAR DEFOGGER/DEFROST
- 59F WINDOW REAR WIPER/WASHER
- 265 CODES/STANDARDS-CSA/CMVSS
- 21V SOUND SYSTEM-DELUXE
- 1B1 CODES STANDARDS/USA
- 14R TV-9" 12V-DC
- 04L JAPAN EXPORT PACKAGE

COPYRIGHT 2003 WINNEBAGO INDUSTRIES, INC.		WINNEBAGO		04 200 SERIES	
DATE	DATE	UNSPECIFIED TOLERANCES ARE:	MATERIAL:		
DATE	DATE	WHOLE DIM (XX)	+		
DATE	DATE	ONE-PLACE (X.X)	+		
DATE	DATE	TWO-PLACE (X.XX)	+		
DATE	DATE	ANGLE	+		
DATE	DATE	THIRD ANGLE PROJECTION	+		
LAYOUT NO	DATE	TITLE:	WIRING INSTL-FRONT END		
DIA #	SCALE: NONE	DO NOT SCALE DIMENSIONS	SHEET	NO	144702
ALL DIMENSIONS ARE IN MILLIMETERS		SHEET	OF 2		
REF: 141373 E		08/11/03			

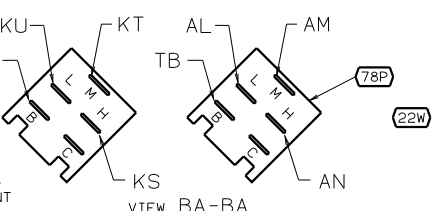
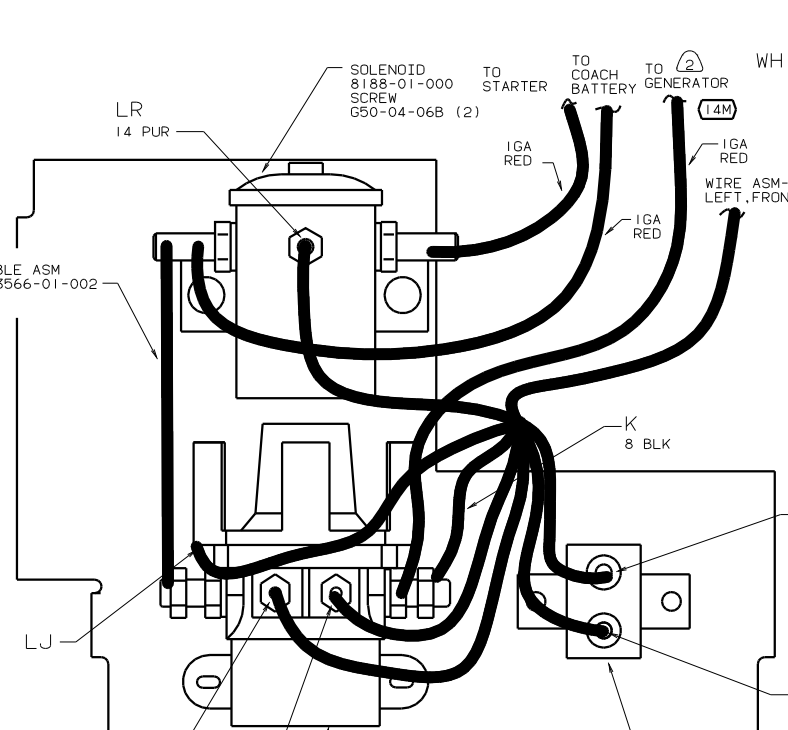
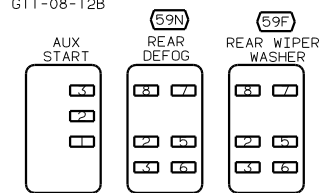
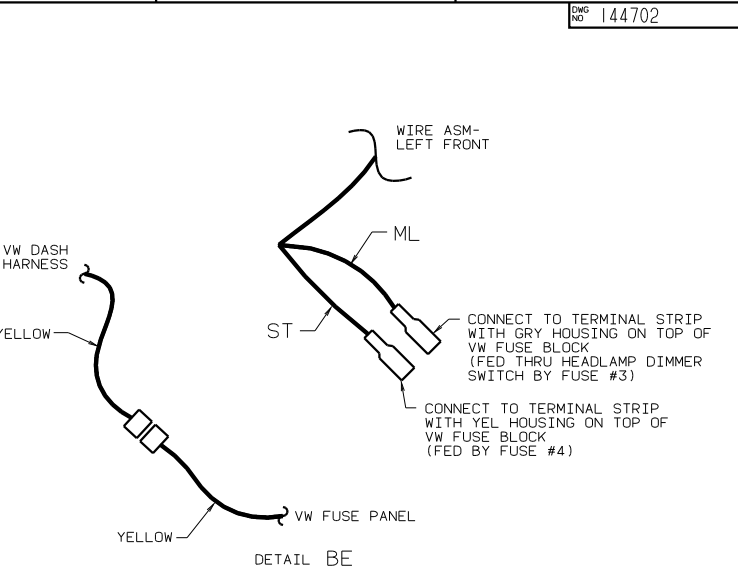
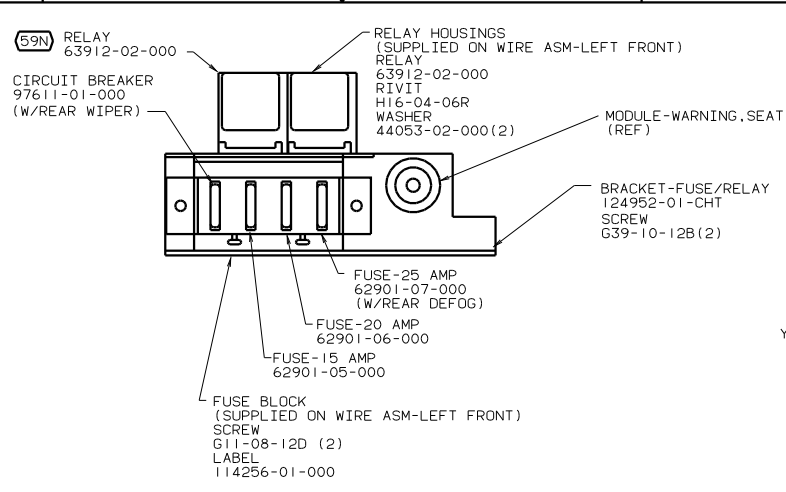
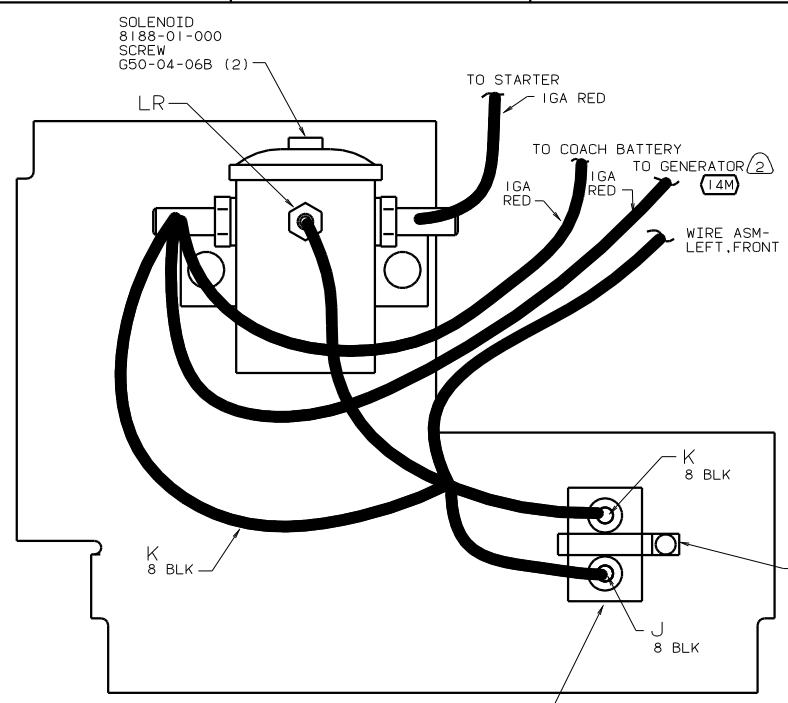

- BATTERY 63739-01-0000 (2)
- TIEDOWN 65450-08-000 (2)
- BOLT 51387-06-000 (2)
- BOLT C27-05-16B (2)
- NUT 44364-12-000 (2)
- NUT D39-05-00B (4)

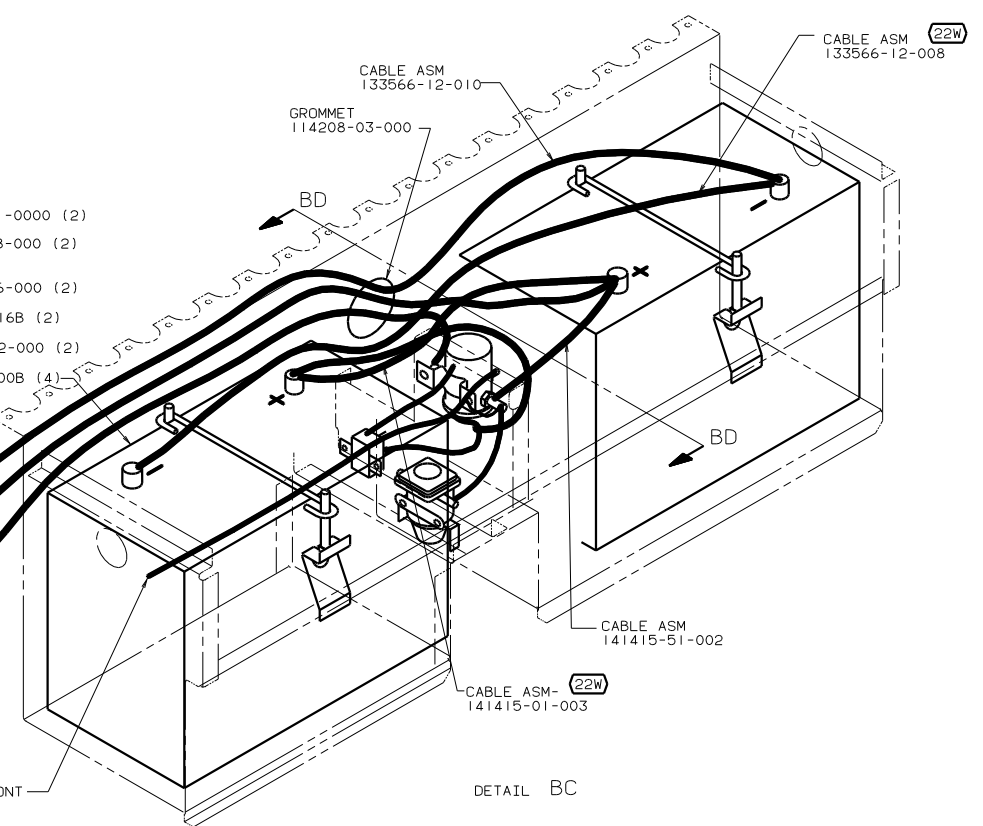
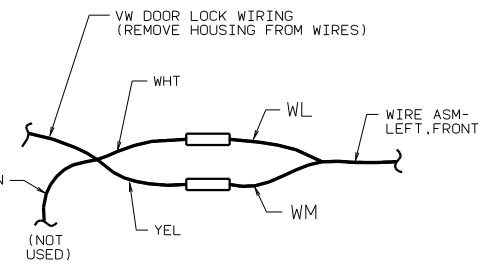
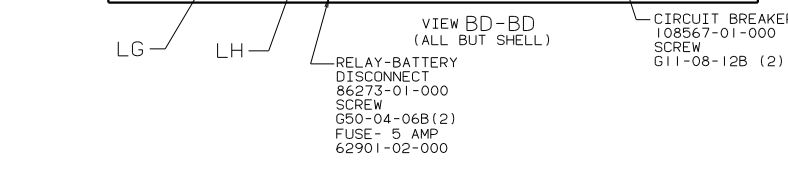

- (78P) A/C AUXILIARY AUTOMOTIVE
- (59N) WINDOW REAR DEFOGGER/DEFROST
- (59F) WINDOW REAR WIPER/WASHER
- (265) CODES/STANDARDS-CSA/CMVSS
- (22W) BATTERY-TWO
- (1B1) CODES STANDARDS/USA
- (14M) GENERATOR-3,000W-GENERAC GAS

(3) SEAL SEAMS AND TOP OF CIRCUIT BREAKER WITH SEALANT 117082-01-000. MINIMIZE CONTACT OF SEALANT WITH ELECTRICALLY CONDUCTIVE SURFACES.

(2) SEE GENERATOR INSTL FOR ADDITIONAL INFORMAITON.

(1) SEE WIRING INSTL-BODY FOR ADDITIONAL INFORMAITON.

DWG NO	SWITCH	SHEET
114014-01	SINGLE	1
114014-02	W/REMOTE	2

REV	DATE	DFTR	ADM	DWG NO	114014
1					
REV	ZONE	REVISION RECORD	DATE	DFTR-ORIG	

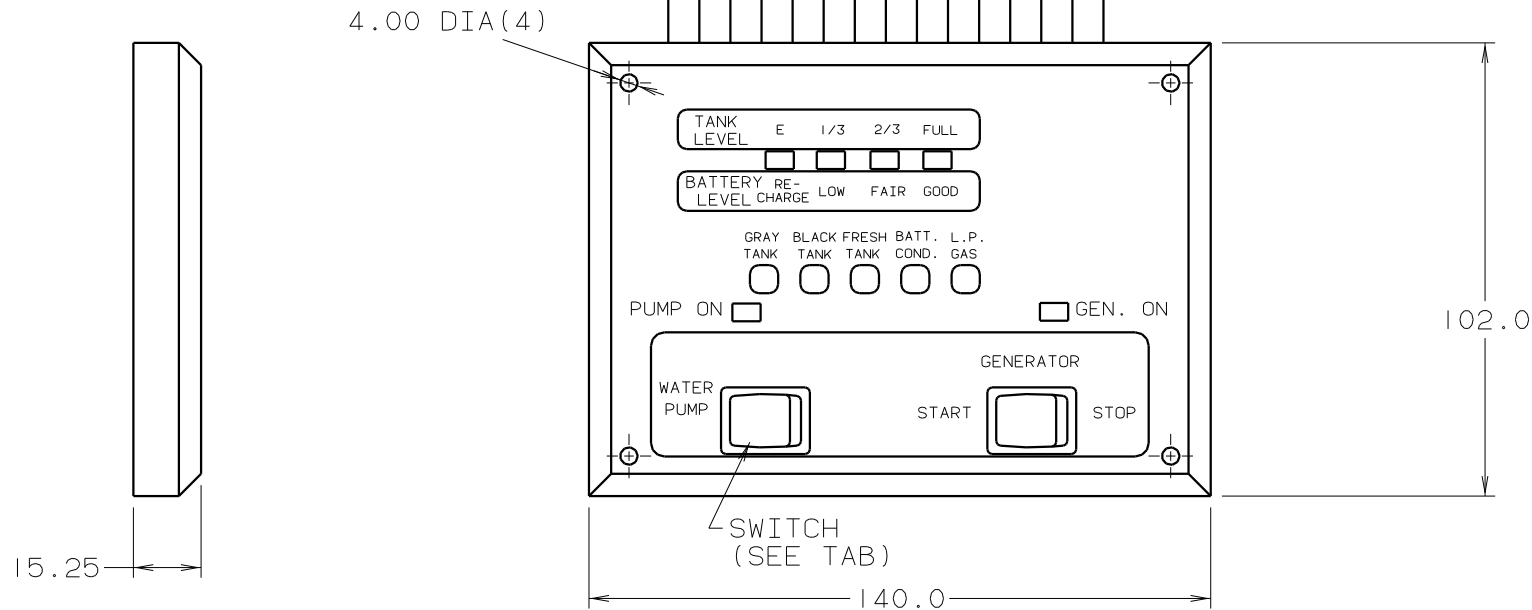
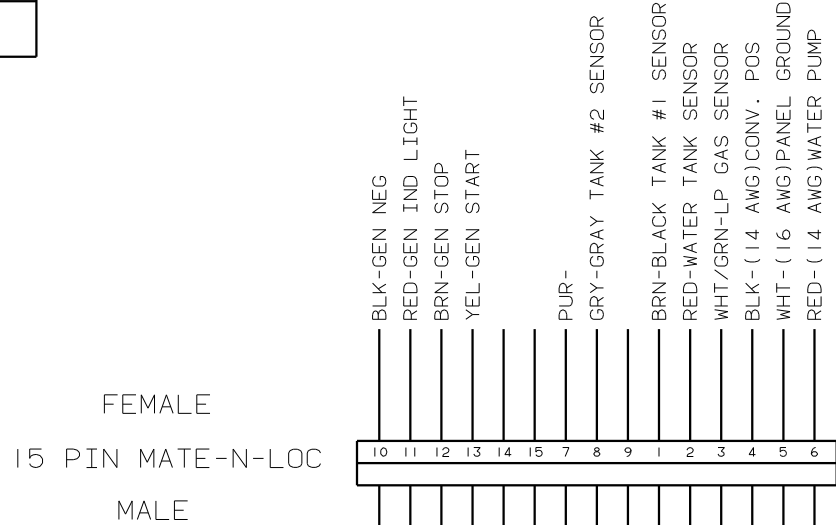

SEE CHART
FOR COLOR VARIATIONS
OF THIS PART

- NOTES:
- 2. UNLESS OTHERWISE SPECIFIED ALL WIRE IS 22 AWG.
 - 1. SUGGESTED VENDOR: PHILLIPS VENT LINE P/N:L9151.

COPYRIGHT 2003 WINNEBAGO INDUSTRIES, INC. **WINNEBAGO** 94 H-SERIES

DFTR	DATE	UNSPECIFIED TOLERANCES ARE:	MATERIAL:
CHKR	DATE	WHOLE DIM (X) ±	
P E	DATE	ONE-PLACE (X.X) ±	
M E	DATE	TWO-PLACE (X.XX) ±	
DSNR	DATE	ANGLE ±	
LAYOUT NO	TITLE:	THIRD ANGLE PROJECTION	
DIA Ø	SCALE: 1.0	PANEL-MONITOR	
ALL DIMENSIONS ARE IN MILLIMETERS		DO NOT SCALE DRAWING	DWG NO 114014
SHEET 1 OF 2		SIZE I C	

D
C
B
A

D
C
B
A

4

3

2

1

4

3

2

1

FEMALE
15 PIN MATE-N-LOC
MALE

- BLK-GEN NEG
- RED-GEN IND LIGHT
- BRN-GEN STOP
- YEL-GEN START
- RED/WHT-REMOTE SWITCH
- WHT/RED-REMOTE SWITCH
- PUR-
- GRY-GRAY TANK #2 SENSOR
- BRN-BLACK TANK #1 SENSOR
- RED-WATER TANK SENSOR
- WHT/GRN-LP GAS SENSOR
- BLK-(14 AWG)CONV. POS
- WHT-(16 AWG)PANEL GROUND
- RED-(14 AWG)WATER PUMP

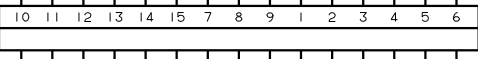

4.00 DIA(4)

15.25

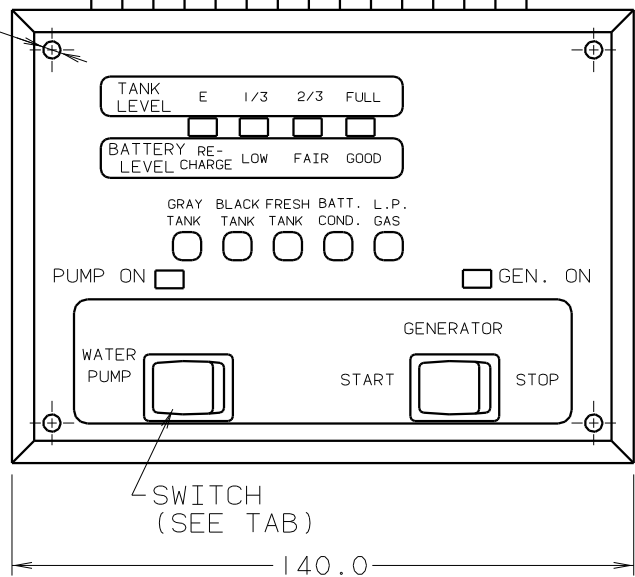

94 H-SERIES

TITLE: PANEL-MONITOR		
DO NOT SCALE DRAWING	SIZE I C	DWG NO 114014
SHEET 2 OF 2		

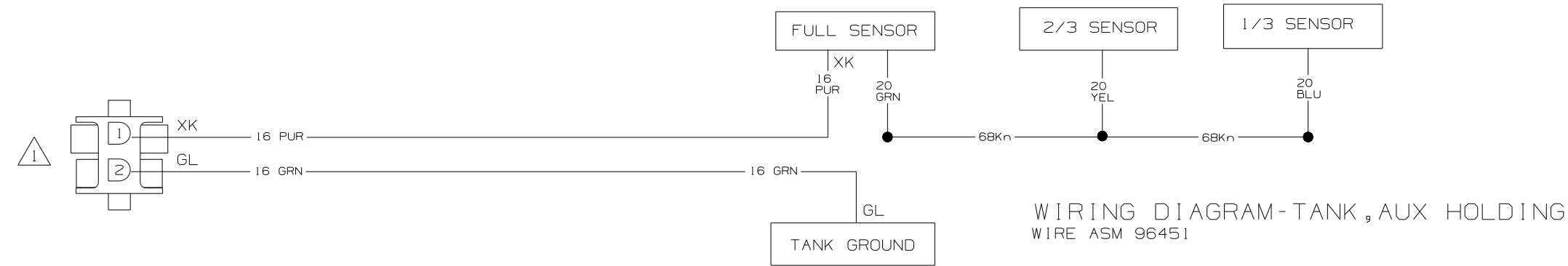
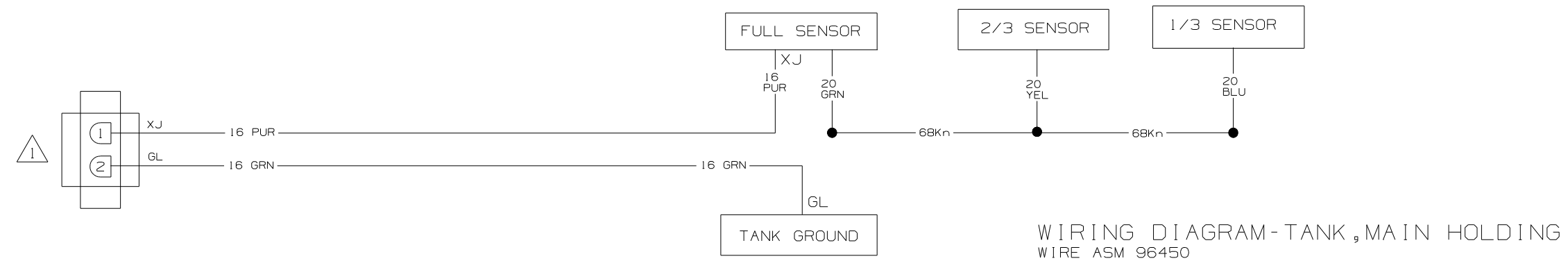
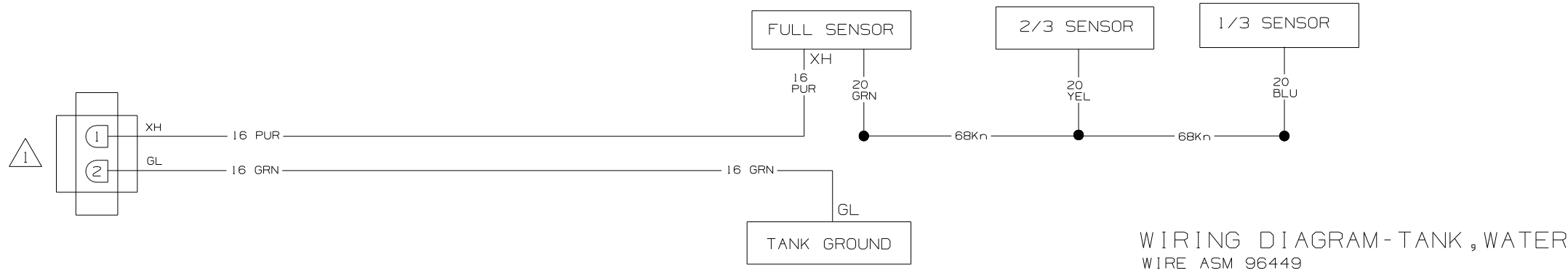

NOTES:
1. SEE WIRING DIAGRAM-BODY FOR ADDITIONAL INFORMATION.

WINNEBAGO		COPYRIGHT 2002 WINNEBAGO INDUSTRIES, INC.	
DFT	ORIG. DATE	ALL DIMENSIONS ARE IN MILLIMETERS	
CHKR		FIRST USED	
P.E.		03 SERIES	
M.E.		UNSPECIFIED TOLERANCES ARE:	
DSNR		MATERIAL:	
		WHOLE DIM (X) :	
		ONE-PLACE (X.X) :	
		TWO-PLACE (X.XX) :	
		ANGLE :	
THIRD ANGLE PROJECTION			
DO NOT SCALE DRAWING			
TITLE: WIRING DIAGRAM-HOLDING TANKS			
SHEET 1 OF 1	PART NO	110664	
REF:	1 11/13/02		

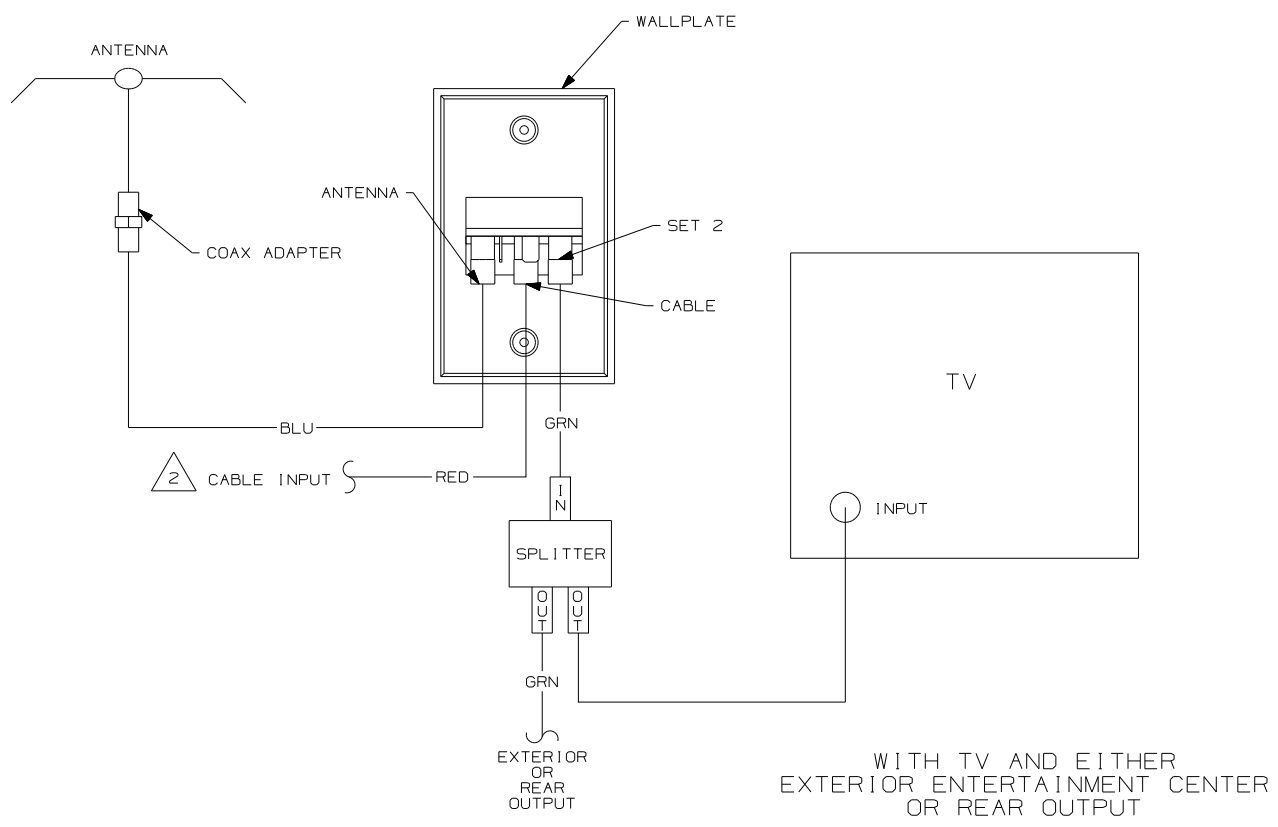

WITH TV AND EITHER EXTERIOR ENTERTAINMENT CENTER OR REAR OUTPUT

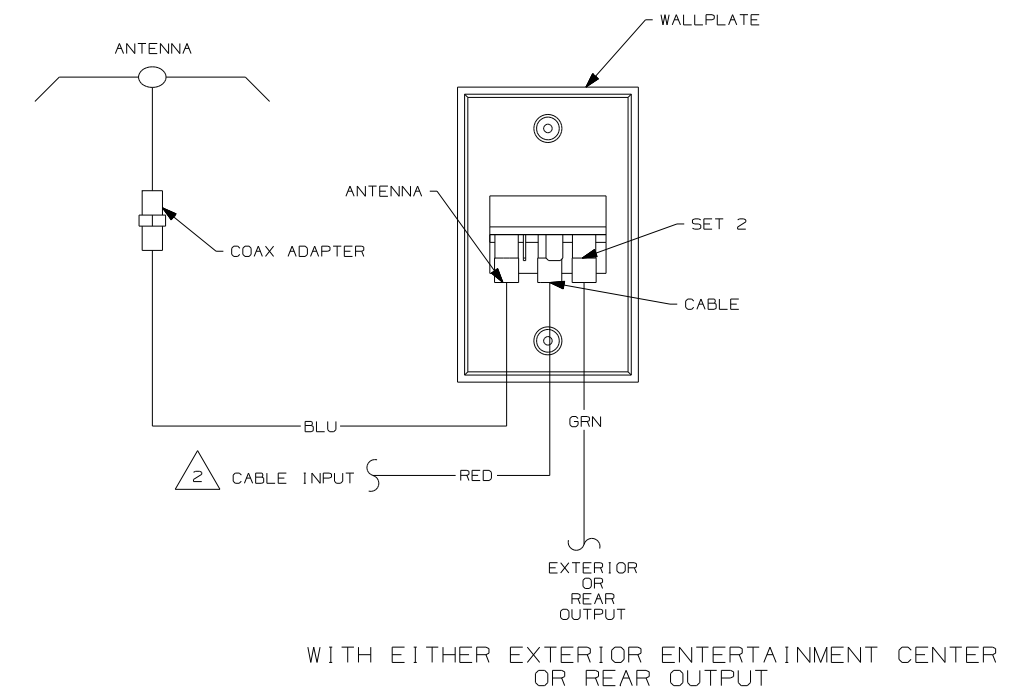

WITH EITHER EXTERIOR ENTERTAINMENT CENTER OR REAR OUTPUT

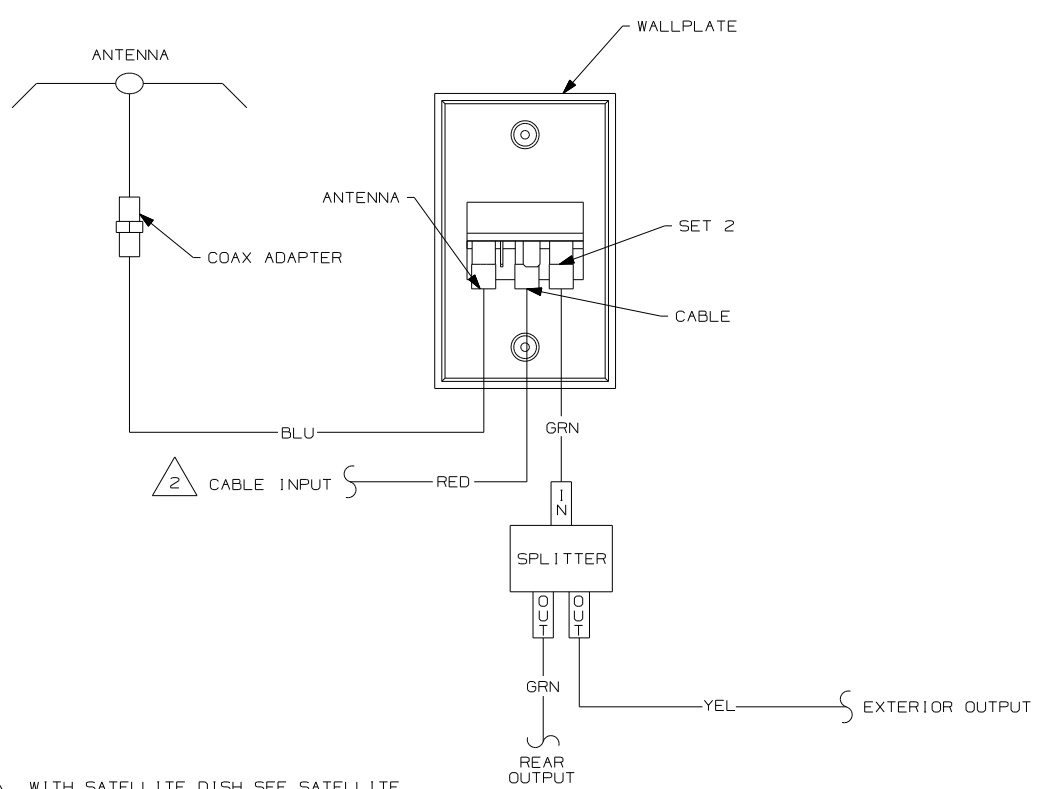

WITH EXTERIOR ENTERTAINMENT CENTER AND REAR OUTPUT

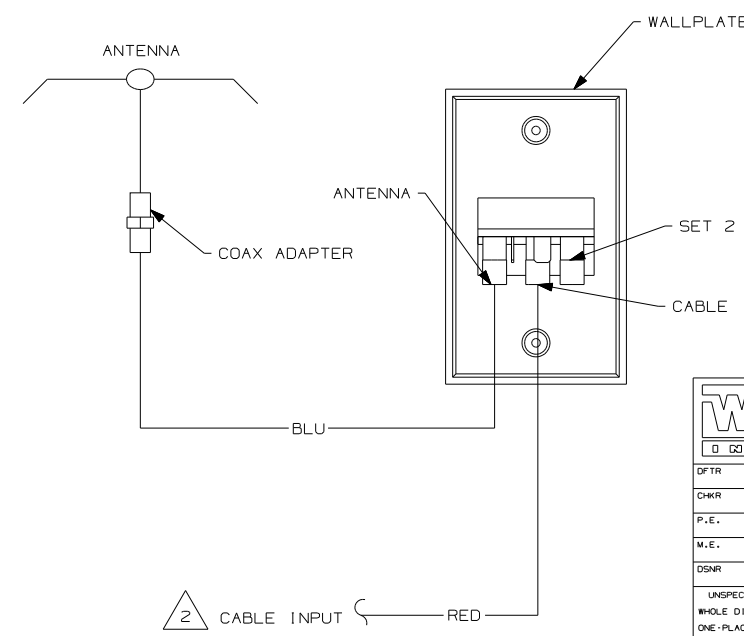

WITHOUT EITHER EXTERIOR ENTERTAINMENT CENTER OR REAR OUTPUT

NOTES:
 2 WITH SATELLITE DISH SEE SATELLITE DISH VIEW SHT 2 BOTTOM LEFT.
 1 COLOR INDICATES IDENTIFICATION TAPE.

WINNEBAGO		COPYRIGHT 2002 WINNEBAGO INDUSTRIES, INC.	
DFTR	ORIG. DATE	ALL DIMENSIONS ARE IN MILLIMETERS	
CHKR		FIRST USED	
P.E.		93 MOTORHAMES	
M.E.		UNSPECIFIED TOLERANCES ARE:	
DSNR		MATERIAL:	
		WHOLE DIM (X)	:
		ONE-PLACE (X.X)	:
		TWO-PLACE (X.XX)	:
		ANGLE	:
		THIRD ANGLE PROJECTION	
DO NOT SCALE DRAWING			
TITLE: WIRING DIAGRAM-TV COAX			
SHEET 1 OF 2	PART NO	110138	
REF:	1 04/29/03		

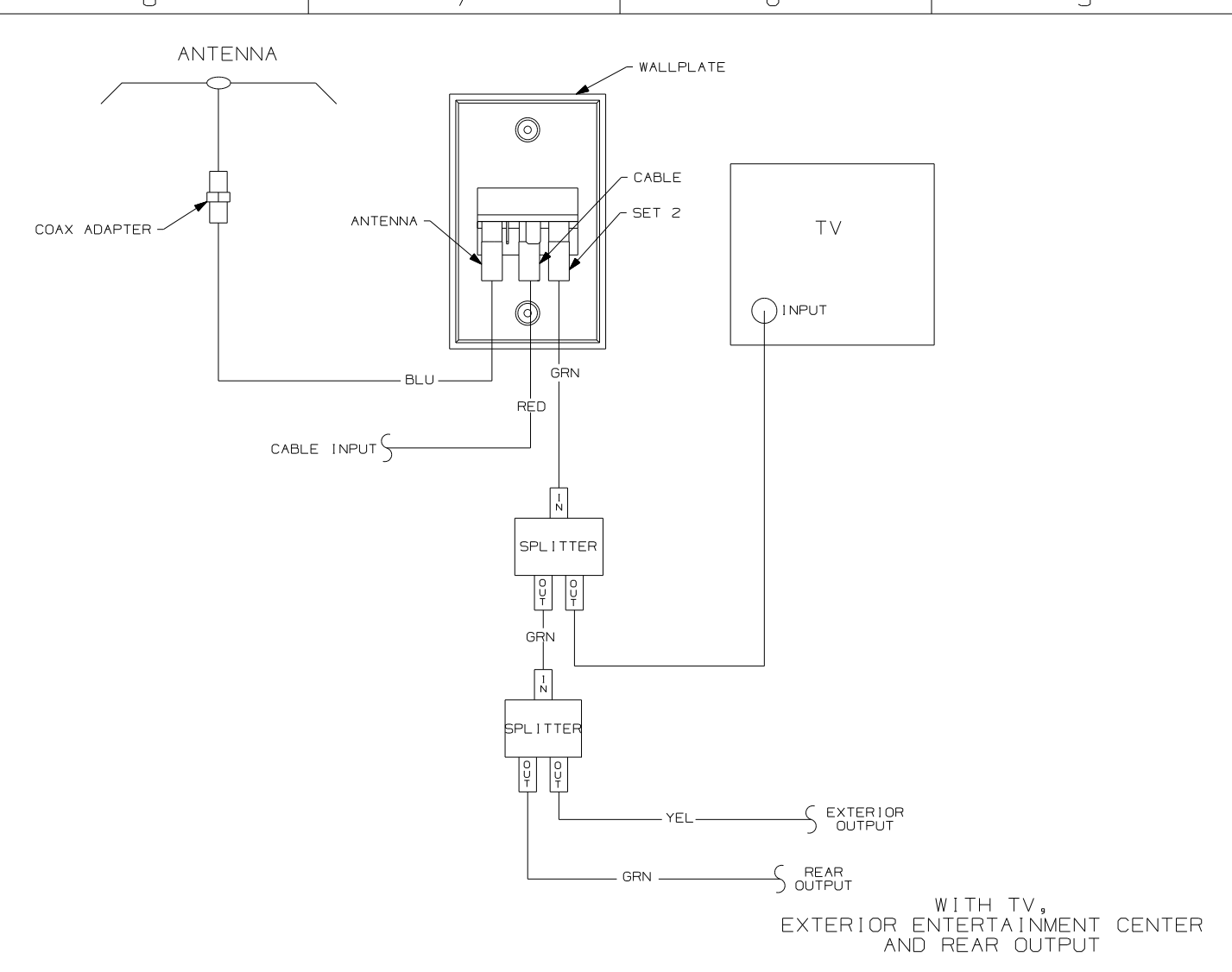

WITH TV, EXTERIOR ENTERTAINMENT CENTER AND REAR OUTPUT

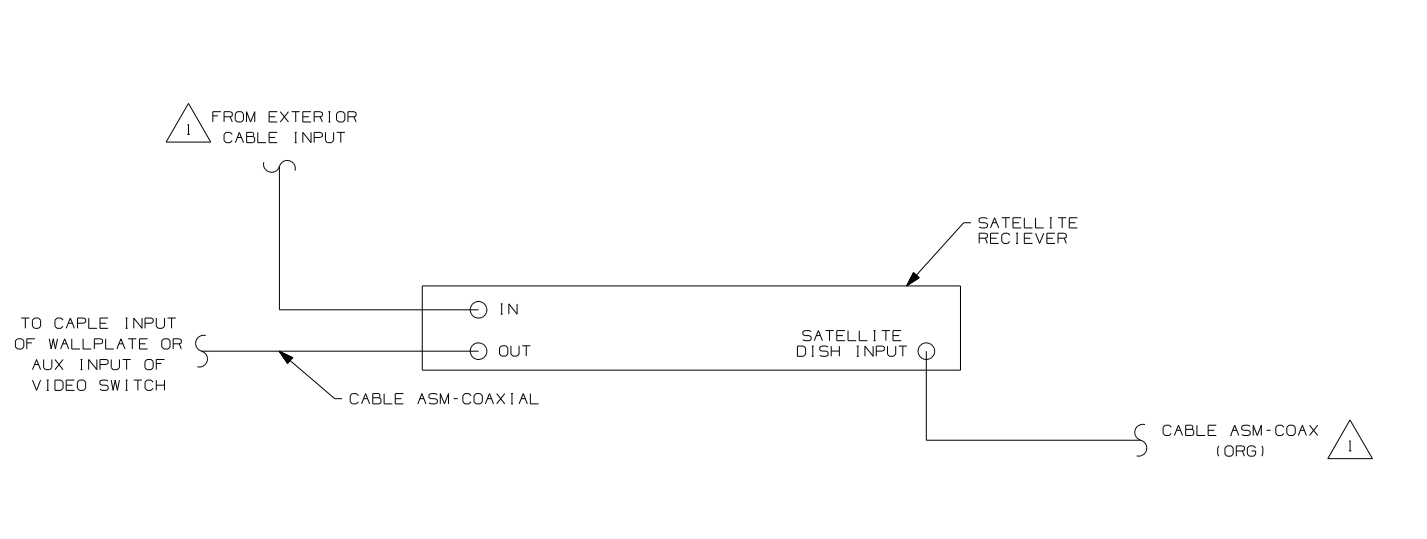

- NOTES:
- 2 WITH SATELLITE DISH SEE SATELLITE DISH VIEW BOTTOM LEFT.
 - 1 CONNECT TV COAX TO JACK ON FRONT OF WALLPLATE.

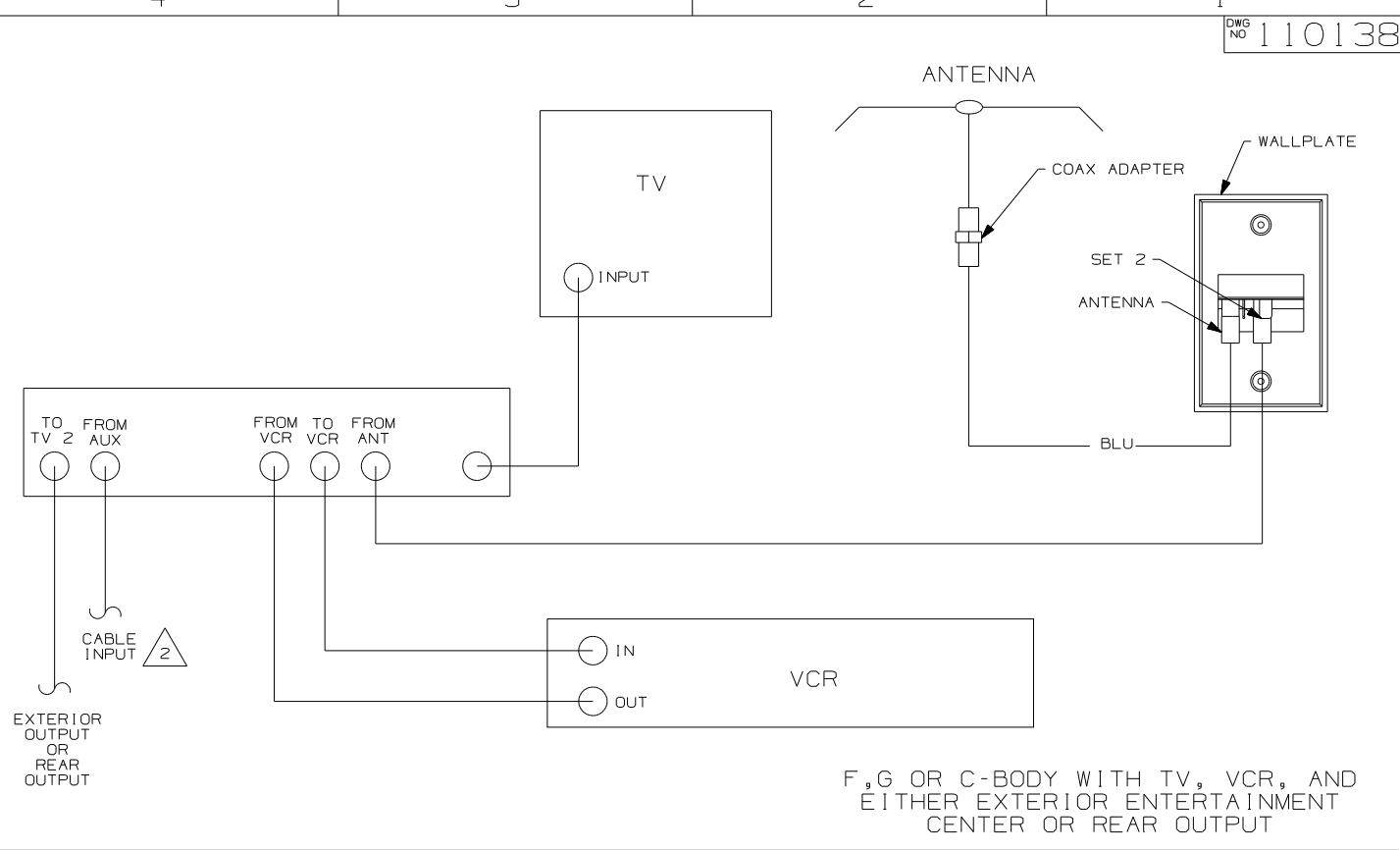

F, G OR C-BODY WITH TV, VCR, AND EITHER EXTERIOR ENTERTAINMENT CENTER OR REAR OUTPUT

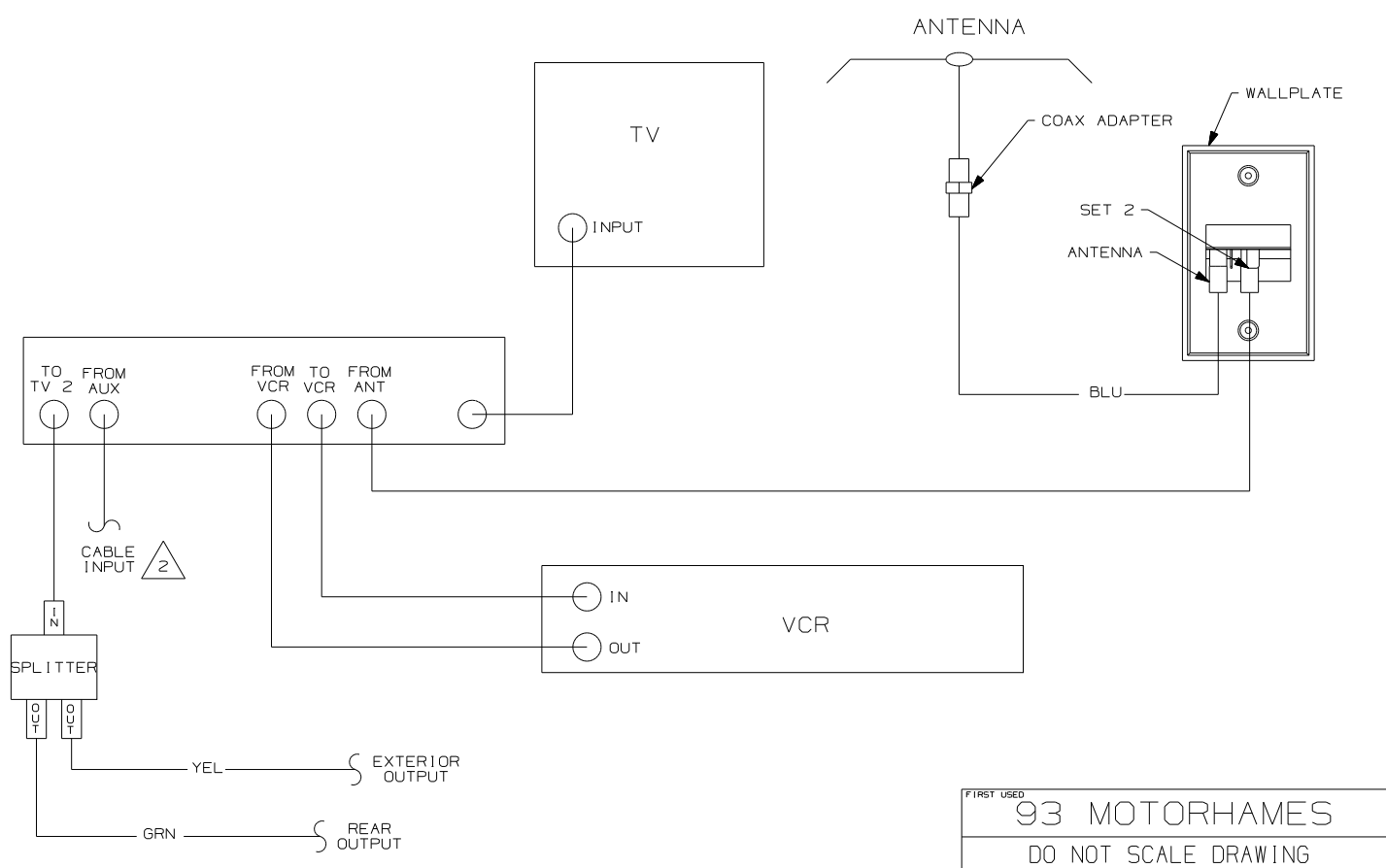

N, M OR P-SERIES WITH TV AND VCR OR F, G OR C-BODY WITH TV, VCR, EXTERIOR ENTERTAINMENT CENTER AND REAR OUTPUT

FIRST USED	93 MOTORHAMES
DO NOT SCALE DRAWING	
TITLE:	WIRING DIAGRAM-TV COAX
SHEET 2	PART NO 110138

TERMINALS

NO.	PART NUMBER	DESCRIPTION
B-1 B-2 B-11 B-12	50003-01 50004-01 50003-02 50004-02	TERMINAL-PIN, 16-14 GA, .156 DIA TERMINAL-RECP, 16-14 GA, .156 DIA TERMINAL-PIN, 16-14 GA, .180 DIA TERMINAL-RECP, 16-14 GA, .180 DIA
WP-1 WP-2 WP-3	106950-01 106950-02 106950-03	TERMINAL-PIN, 16-14 GA TERMINAL-PIN, 10-12 GA TERMINAL-PIN, 8 GA
R-1 R-2 R-3 R-4 R-5 R-6 R-7 R-8 R-9	35416-01 35416-02 35416-03 35416-04 37018-01 102777-01 102777-02 102777-03 33787-01	TERMINAL-RING, 8 GA, #10 STUD TERMINAL-RING, 6 GA, #10 STUD TERMINAL-RING, 12-10 GA, #10 STUD TERMINAL-RING, 16-14 GA, #10 STUD TERMINAL-RING, 12-10 GA, 5/16 STUD TERMINAL-RING, #6 STUD, 14-16 GA TERMINAL-RING, #6 STUD, 10-12 GA TERMINAL-RING, #6 STUD, 8 GA TERMINAL-RING, 14 GA, #10 STUD
R-60 R-61 R-62 R-63 R-64 R-65 R-66 R-67 R-68 R-69 R-70 R-71	8325-01 8326-01 8327-01 8328-01 8328-02 8329-01 8331-01 8332-01 8332-02 8350-01 99275-02 101397-01	TERMINAL-RING, 16-14 GA, 1/4 STUD TERMINAL-RING, 16-14 GA, 3/8 STUD TERMINAL-RING, 16-14 GA, #10 STUD TERMINAL-RING, 12-10 GA, #10 STUD TERMINAL-RING, 12-10 GA, 3/8 STUD TERMINAL-RING, 8 GA, 3/8 STUD TERMINAL-RING, 4 GA, 3/8 STUD TERMINAL-RING, 6 GA, 1/4 STUD TERMINAL-RING, 10 GA, 1/4 STUD TERMINAL-RING, 6 GA, 3/8 STUD TERMINAL-RING, 8 GA, 7/16 STUD TERMINAL-RING, 16-14 GA, #10 STUD
R-91 R-92 R-93 R-94	88791-01 88791-02 8348-01 99275-01	TERMINAL-RING, 1/0 GA, 3/8, 90 DEG. TERMINAL-RING, 2 GA, 3/8, 90 DEG TERMINAL-RING, 2 GA, 3/8 STUD TERMINAL-RING, 1/0 GA, 7/16 STUD
RF-51 RF-52	7944-01 7945-01	TERMINAL-RING, 12-10 GA, #8 STUD TERMINAL-RING, 16-14 GA, #8 STUD
TR-1 TR-2 TR-11 TR-12	47443-01 47443-02 47443-03 47443-04	TERMINAL-RECP, 16-14 GA, .25, INS TERMINAL-RECP, 12-10 GA, .25, INS TERMINAL-RECP, 16-14 GA, .19, INS TERMINAL-RECP, 16-14 GA, .11, INS
TR-21 TR-22 TR-23	80015-01 80015-02 80015-03	TERMINAL-RECP, 22-18 GA, .250, 90 DEG TERMINAL-RECP, 16-14 GA, .190, 90 DEG TERMINAL-RECP, 16-14 GA, .250, 90 DEG
TR-51 TR-52 TR-53 TR-54 TR-55	7940-01 23809-01 23809-02 49270-01 7940-02	TERMINAL-RECP, 16-12 GA, .25, UNINS TERMINAL-RECP, 16-14 GA, .19, UNINS TERMINAL-RECP, 18-20 GA, .25, UNINS TERMINAL-RECP, 18-20 GA, .19, UNINS TERMINAL-RECP, 10 GA, .25, UNINS
TT-1	85745-02	TERMINAL-TAB, 16-14 GA, .25, INS
TT-51 TT-52	7942-01 7943-01	TERMINAL-TAB, 16-14 GA, .25, UNINS TERMINAL-TAB, 14-10 GA, .25, UNINS
MF6-1 MF6-2	129236-01 129236-02	TERMINAL-FEM, M/P, 630, 10-12 TERMINAL-FEM, M/P, 630, 14-16

SPLICES

NO.	PART NUMBER	DESCRIPTION
BS-1 BS-2 BS-3 BS-SB	31876-01 31876-02 31876-03 100070-01	SPLICE-BUTT, 16-14 GA, BLUE SPLICE-BUTT, 12-10 GA, YELLOW SPLICE-BUTT, 22-18 GA, RED SPLICE-BUTT, 14-16 GA, SHRINK, BLUE
BS-RB	112823-01	SPLICE-BUTT, 14-22 GA, REDUCER
S-1 S-2	7946-01 23808-01	SPLICE, 1-6 MM ² SPLICE, 6-9 MM ²
I-2 I-5	7956-02 7956-05	SHRINK WRAP .375 DIA SHRINK WRAP .25 DIA
SH-1	58028-01	SPLICE-HAT
S-10	101173-01	SPLICE-BARREL, 26300 CMA

NO.	PART NUMBER	DESCRIPTION
SP-1	90986-02	PLUG ASM-ELECTRIC STEP
SP-2	142524-01-000 098261-01-000 098262-07-000 098261-02-000 (3) 098262-01-000 (3)	HOUSING-4 PIN SOCKET-CONNECTOR SEAL-CONNECTOR SOCKET-CONNECTOR SEAL-CONNECTOR
HR-1	63910-01	HOUSING-RELAY
MP-8 MP-10 MPP CAV-1 CON-3	125323-02 125323-01 125324-01 125325-01 98262-03	HOUSING-PIN, 8 CAVITY HOUSING-PIN, 10 CAVITY TERMINAL-MALE, M/P, 150 SEAL-CAVITY, 150-SERIES M/P SEAL-CONNECTOR
LS-8 LS-10	125323-03 125323-04	LOCK-SECONDARY 8 POSITION LOCK-SECONDARY 10 POSITION
H-8 H-12	108355-01 108355-02	HOUSING-SWITCH, 8 POSITION HOUSING-SWITCH, 12 POSITION

NO.	PART NUMBER	DESCRIPTION
GEN-1	125323-02-000 125324-01-000 (4) 098262-03-000 (4) 125325-01-000 (4) 125323-03-000	HOUSING-8 POSN, MALE, 150 SERIES TERMINAL-MALE, M/P, 150 SEAL-CONNECTOR SEAL-CAVITY, 150 SERIES M/P LOCK-SECONDARY 8 POSITION
GEN-2	125323-01-000 125324-01-000 (5) 098262-03-000 (5) 125325-01-000 (5) 125323-04-000	HOUSING-10 POSN, MALE, 150 SERIES TERMINAL-MALE, M/P, 150 SEAL-CONNECTOR SEAL-CAVITY, 150 SERIES M/P LOCK-SECONDARY 10 POSITION

HOUSINGS AND TERMINALS

NO.	PART NUMBER	DESCRIPTION
HS-2 HS-3 HS-4 HS-5 HS-6 HS-7 HS-9 HS-12 HS-15	88474-10 88474-09 88474-08 88474-07 88474-06 88474-05 88474-03 88474-01 88474-02	HOUSING-SOCKET, 2 CAVITY HOUSING-SOCKET, 3 CAVITY HOUSING-SOCKET, 4 CAVITY HOUSING-SOCKET, 5 CAVITY HOUSING-SOCKET, 6 CAVITY HOUSING-SOCKET, 6 CAVITY HOUSING-SOCKET, 9 CAVITY HOUSING-SOCKET, 12 CAVITY HOUSING-SOCKET, 15 CAVITY
HP-2 HP-3 HP-4 HP-5 HP-6 HP-7 HP-8 HP-9 HP-12 HP-15	88473-10 88473-09 88473-08 88473-07 88473-06 88473-05 88473-04 88473-03 88473-01 88473-02	HOUSING-PIN, 2 CAVITY HOUSING-PIN, 3 CAVITY HOUSING-PIN, 4 CAVITY HOUSING-PIN, 5 CAVITY HOUSING-PIN, 6 CAVITY HOUSING-PIN, 6 CAVITY HOUSING-PIN, 8 CAVITY HOUSING-PIN, 9 CAVITY HOUSING-PIN, 12 CAVITY HOUSING-PIN, 15 CAVITY
TS-1 TS-2	88476-01 88476-02	SOCKET-CONNECTOR, 16-14 GA SOCKET-CONNECTOR, 12-10 GA
TP-1 TP-2	88475-01 88475-02	PIN-CONNECTOR, 16-14 GA PIN-CONNECTOR, 12-10 GA
HS2HA HP2HA	137208-01 137207-01	HOUSING-SOCKET, 2 CAVITY-HIGH AMP HOUSING-PIN, 2 CAVITY-HIGH AMP
TS-HA TP-HA	137210-01 137209-01	SOCKET-CONNECTOR, 10AWG HIGH AMP PIN-CONNECTOR, 10AWG HIGH AMP

BALLOON CALLOUT LEGEND

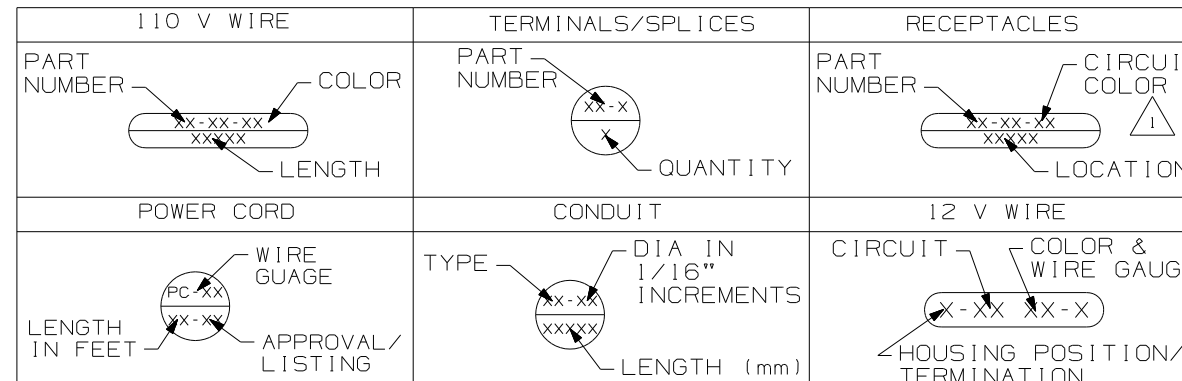

NOTES:
 2 INACTIVE
 1 FOR RECP-BLANK, DET-X DENOTES DETAIL VIEW.

WINNEBAGO COPYRIGHT 2004 WINNEBAGO INDUSTRIES, INC.

ALL DIMENSIONS ARE IN MILLIMETERS

96 MH'S

DO NOT SCALE DRAWING

TITLE: PART LISTING-ELECTRICAL

SHEET 1 OF 7 PART NO 121339

REF: 1 5/3/2004

WIRE-SINGLE INS CONDUCTOR, STRANDED

NO.	PART NUMBER	DESCRIPTION
16-Y 16-W	89360-01 89360-02	WIRE, 16 GA. YELLOW WIRE, 16 GA. WHITE
14-Y 14-W	48554-02 48554-04	WIRE, 14 GA. YELLOW WIRE, 14 GA. WHITE
12-Y 12-W	48555-02 48555-04	WIRE, 12 GA. YELLOW WIRE, 12 GA. WHITE
10-Y 10-W	8000-03 8000-05	WIRE, 10 GA. YELLOW WIRE, 10 GA. WHITE
8-B 8-G	8005-01 8005-03	WIRE, 8 GA. BLACK WIRE, 8 GA. GREEN
6-B 6-G	70065-01 70065-03	WIRE, 6 GA. BLACK WIRE, 6 GA. GREEN
18-WX	121015-01	WIRE, 18 GA. WHITE, XLPE
16-YX 16-WX	116675-01 116675-02	WIRE, 16 GA. YELLOW, XLPE WIRE, 16 GA. WHITE, XLPE
14-YX 14-WX	98586-01 98586-02	WIRE, 14 GA. YELLOW, XLPE WIRE, 14 GA. WHITE, XLPE
12-YX 12-WX	98609-01 98609-02	WIRE, 12 GA. YELLOW, XLPE WIRE, 12 GA. WHITE, XLPE
10-YX 10-WX	116676-03 116676-04	WIRE, 10 GA. YELLOW, XLPE WIRE, 10 GA. WHITE, XLPE
8-BX 8-GX	116674-01 116674-02	WIRE, 8 GA. BLACK, XLPE WIRE, 8 GA. GREEN, XLPE
6-BX 6-GX	116687-01 116687-02	WIRE, 6 GA. BLACK, XLPE WIRE, 6 GA. GREEN, XLPE

RECEPTACLES

NO.	PART NUMBER	DESCRIPTION
RCP-1	86738-02-CHT	RECEPTACLE-SINGLE, FLUSH MOUNT
RCP-2	86738-01-CHT	RECEPTACLE-DOUBLE, FLUSH MOUNT
RCP-3	58707-01-000	RECEPTACLE-SINGLE, SURFACE MOUNT
RCP-B	58707-02-000	RECEPTACLE-BLANK, JUNCTION
RCP-E	131826-01-CHT	INCLUDES COVER & GASKET

WIRE-NM SHEATHED CABLE

NO.	PART NUMBER	DESCRIPTION
14 UL	8027-01-000	WIRE 14-2 ROMEX W/GROUND (UL)
14 CA	8023-02-000	WIRE 14-2 ROMEX W/GROUND (CAN)
12 UL	8026-01-000	WIRE 12-2 ROMEX W/GROUND (UL)
12 CA	8023-01-000	WIRE 12-2 ROMEX W/GROUND (CAN)
12-3 UL	8026-03-000	WIRE 12-3 ROMEX W/GROUND (UL)
12-3 CA	8023-03-000	WIRE 12-3 ROMEX W/GROUND (CAN)
10 UL	8022-01-000	WIRE 10-2 ROMEX W/GROUND (UL)
10 CA	24743-01-000	WIRE 10-2 ROMEX W/GROUND (CAN)
6-3 UL	108914-01-000	WIRE 6-3 ROMEX W/GROUND (UL)
6-3 CA	113136-01-000	WIRE 6-3 ROMEX W/GROUND (CAN)
6-2 UL	108914-02-000	WIRE 6-2 ROMEX W/GROUND (UL)
4-3 UL	128375-01-000	WIRE 4-3 ROMEX W/GROUND (UL)
4-3 CA	128375-01-000	WIRE 4-3 ROMEX W/GROUND (CAN)

POWER CORDS

NO.	PART NUMBER	DESCRIPTION
PC-10 28	8054-01-000	POWER CORD 10 GA, 30 AMP, 28 FT. (UL/CA)
PC-10 35	8054-02-000	POWER CORD 10 GA, 30 AMP, 35 FT. (UL/CA)
PC-10 30-CA	8052-01-000	SUPERCEEDED BY 8054-01-000
PC-6 36	108934-01-000	POWER CORD 6 GA, 50 AMP, 36 FT. (UL/CA)
PC-6 36-FX	108934-02-000	POWER CORD 6 GA, 50 AMP, 36 FT. (UL/CSA) SUPERFLEX
PC-6 36-CA	113096-01-000	SUPERCEEDED BY 108934-02-000

CIRCUIT COLOR LEGEND

110V CIRCUIT	WIRE COLOR	COAXIAL CIRCUIT
A/C CIRCUIT 1	RED	CABLE INPUT W/O SPLITTER
A/C CIRCUIT 2	GRN	REAR TV W/O SPLITTER
GENERAL RECPS 1	BLU	ANTENNA
GENERAL RECPS 2	BRN	FRONT TV
GENERAL RECPS 3	PUR	VCR INPUT
GENERAL RECPS 4	GRY	
REFRIGERATOR/ CONVERTER	YEL	EXT ENT CTR
MICROWAVE	BLK	AUX INPUT
WATER HEATER	WHT	
WASHER/DRYER	GLD	
DISHWASHER	SIL	
	ORG	SATELLITE PLATE INPUT
	ORG/ORG	SATELLITE PLATE OUTPUT
	RED/RED	CABLE INPUT W/SPLITTER
	GRN/GRN	REAR TV W/SPLITTER
	PUR/PUR	VCR OUTPUT

CONDUIT





NO.	PART NUMBER	DESCRIPTION	TEMP.
C-4	41953-07-000	CONDUIT-CONVOLUTE, SLIT .25" ID	194° F
C-6	41953-06-000	CONDUIT-CONVOLUTE, SLIT .38" ID	194° F
C-8	41953-01-000	CONDUIT-CONVOLUTE, SLIT .50" ID	194° F
C-10	41953-02-000	CONDUIT-CONVOLUTE, SLIT .63" ID	194° F
C-16	41953-03-000	CONDUIT-CONVOLUTE, SLIT 1.0" ID	194° F
C-24	41953-08-000	CONDUIT-CONVOLUTE, SLIT 1.5" ID	194° F
C-32	41953-15-000	CONDUIT-CONVOLUTE, SLIT 2.0" ID	194° F
CX-8	41953-09-000	CONDUIT-CONVOLUTE, SLIT .50" ID	239° F
CX-12	41953-10-000	CONDUIT-CONVOLUTE, SLIT .75" ID	239° F
CX-16	41953-11-000	CONDUIT-CONVOLUTE, SLIT 1.0" ID	239° F
CX-20	41953-13-000	CONDUIT-CONVOLUTE, SLIT 1.25" ID	239° F
CX-24	41953-14-000	CONDUIT-CONVOLUTE, SLIT 1.50" ID	239° F
CX-32	41953-16-000	CONDUIT-CONVOLUTE, SLIT 2.0" ID	239° F
CN-10	41953-05-000	CONDUIT-CONVOLUTE, NOT SLIT .63" ID	194° F
CN-16	41953-12-000	CONDUIT-CONVOLUTE, NOT SLIT 1.0" ID	194° F

BATTERY CABLE LEGEND

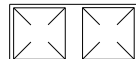

COLOR	DESCRIPTION
PURPLE	CHASSIS BATTERY TO SOLENOID
BLUE	HYDRAULIC JACKS PUMP
RED	BATTERY TO STARTER
GREEN	BATTERY TO GENERATOR
YELLOW	COACH BATTERY TO SOLENOID

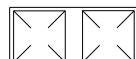
FIRST USED	96 MH'S
TITLE	DO NOT SCALE DRAWING
TITLE	PART LISTING-ELECTRICAL
SHEET 2	PART NO 121339

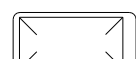



LAMP ASM-PACKAGE, PANCAKE

NO	PART NUMBER	DESCRIPTION
LF1-1	LAMP 98024-01-CHT SCREW G11-08-16U (4) CONNECTOR 58028-01-000 (2)	LAMP ASM, FROSTED LENS, 1 BULB W/SWITCH PROGRESSIVE DYNAMICS INC. 
LF2-1	LAMP 98024-03-CHT SCREW G11-08-16U (6) CONNECTOR 58028-01-000 (2)	LAMP ASM, FROSTED LENS, 2 BULB W/SWITCH PROGRESSIVE DYNAMICS INC. 
LO1-1	LAMP 98024-05-CHT SCREW G11-08-16U (4) CONNECTOR 58028-01-000 (2)	LAMP ASM, OPTI CLEAR LENS, 1 BULB W/SWITCH PROGRESSIVE DYNAMICS INC. 
LO2-1	LAMP 98024-06-CHT SCREW G11-08-16U (6) CONNECTOR 58028-01-000 (2)	LAMP ASM, OPTI CLEAR LENS, 2 BULB W/SWITCH PROGRESSIVE DYNAMICS INC. 
LF1N1	LAMP 98024-07-CHT SCREW G11-08-16U (4) CONNECTOR 58028-01-000 (2)	LAMP ASM, FROSTED LENS, 1 BULB W/O SWITCH PROGRESSIVE DYNAMICS INC. 
LF2N1	LAMP 98024-08-CHT SCREW G11-08-16U (6) CONNECTOR 58028-01-000 (2)	LAMP ASM, FROSTED LENS, 2 BULB W/O SWITCH PROGRESSIVE DYNAMICS INC. 
LFSN1	LAMP 98024-09-CHT SCREW G11-08-16U (6) CONNECTOR 58028-01-000 (2)	LAMP ASM, SINGLE FROSTED LENS, 2 BULB W/O SWITCH PROGRESSIVE DYNAMICS INC. 

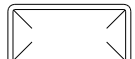

LAMP ASM-PACKAGE, HALOGEN

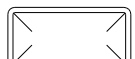
NO	PART NUMBER	DESCRIPTION
HAL	LAMP 123775-01-CHT SCREW (SUPPLIED) CONNECTOR 58028-01-000 (2)	LAMP ASM-HALOGEN, READING 1 BULB 
HAL-S	LAMP 123775-01-CHT SPACER 123775-02-CHT SCREW G13-06-16U (3) CONNECTOR 58028-01-000 (2)	LAMP ASM-HALOGEN, READING WITH 3/4" SPACER 1 BULB 

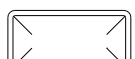
LAMP ASM-PACKAGE, PANCAKE

NO	PART NUMBER	DESCRIPTION
LF1-2	LAMP 137417-01-CHT SCREW G11-08-16U (4) CONNECTOR 58028-01-000 (2)	LAMP ASM, FROSTED LENS, 1 BULB W/SWITCH PROGRESSIVE DYNAMICS INC. 
LF2-2	LAMP 137417-04-CHT SCREW G11-08-16U (6) CONNECTOR 58028-01-000 (2)	LAMP ASM, FROSTED LENS, 2 BULB W/SWITCH PROGRESSIVE DYNAMICS INC. 
LO1-2	LAMP 137417-02-CHT SCREW G11-08-16U (4) CONNECTOR 58028-01-000 (2)	LAMP ASM, OPTI CLEAR LENS, 1 BULB W/SWITCH PROGRESSIVE DYNAMICS INC. 
LO2-2	LAMP 137417-05-CHT SCREW G11-08-16U (6) CONNECTOR 58028-01-000 (2)	LAMP ASM, OPTI CLEAR LENS, 2 BULB W/SWITCH PROGRESSIVE DYNAMICS INC. 
LF1N2	LAMP 137417-03-CHT SCREW G11-08-16U (4) CONNECTOR 58028-01-000 (2)	LAMP ASM, FROSTED LENS, 1 BULB W/O SWITCH PROGRESSIVE DYNAMICS INC. 
LFSN2	LAMP 137417-06-CHT SCREW G11-08-16U (6) CONNECTOR 58028-01-000 (2)	LAMP ASM, SINGLE FROSTED LENS, 2 BULB W/O SWITCH PROGRESSIVE DYNAMICS INC. 

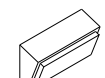
LAMP ASM-PACKAGE, PORCH

NO	PART NUMBER	DESCRIPTION
LEXT-1	LAMP 97917-01-CHT SCREW G67-10-129 (4) CONNECTOR 58028-01-000 (2)	LAMP ASM-PORCH, SURFACE MOUNT BARGMAN 
LEXT-2UL	LAMP 8089-01-000 SCREW G68-06-10E (2) CONNECTOR 58028-01-000 (2)	LAMP ASM-PORCH, RECESSED UL LIST JRV PROD 
LEXT-2CA	LAMP 8089-02-000 SCREW G68-06-10E (2) CONNECTOR 58028-01-000 (2)	LAMP ASM-PORCH, RECESSED CAN LIST JRV PROD 

LEGEND

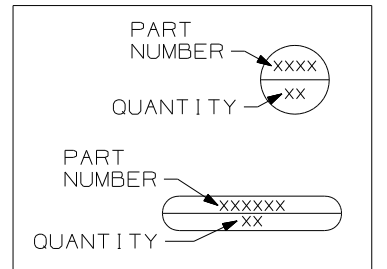



FIRST USED	96 MH'S
TITLE	DO NOT SCALE DRAWING
TITLE	PART LISTING-ELECTRICAL
SHEET 3	PART NO 121339

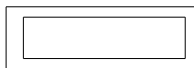
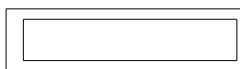
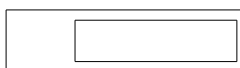
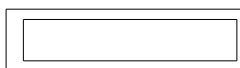
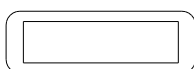
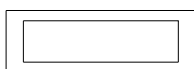
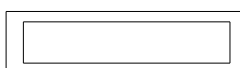
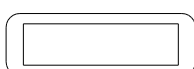
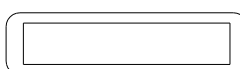

LAMP ASM-PACKAGE, FLUORESCENT

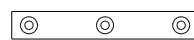
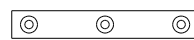
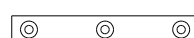
NO	PART NUMBER	DESCRIPTION
FLU-1	LAMP 91936-02-CHT SCREW G11-08-12U (4) CONNECTOR 58028-01-000 (2)	LAMP ASM-FLUORESCENT 12" 2 BULB W/SWITCH THIN-LITE 
FLU-2	LAMP 91936-01-CHT SCREW G11-08-12U (4) CONNECTOR 58028-01-000 (2)	LAMP ASM-FLUORESCENT 18" 2 BULB W/SWITCH THIN-LITE 
FLU-3	LAMP 127327-01-CHT SCREW G11-08-12U (2) CONNECTOR 58028-01-000 (2)	LAMP ASM-FLUORESCENT 18" 1-12" BULB W/SWITCH THIN-LITE 
FLU-4	LAMP 130338-01-CHT SCREW G11-08-12U (4) CONNECTOR 58028-01-000 (2)	LAMP ASM-FLUORESCENT 18" 2 BULB SURFACE MOUNT W/SWITCH THIN-LITE 
FLU-5	LAMP 91936-06-CHT SCREW G11-08-12U (4) CONNECTOR 58028-01-000 (2)	LAMP ASM-FLUORESCENT 12" 2 BULB W/SWITCH THIN-LITE  CUTOUT-122 X 336
FLUN1	LAMP 91936-04-CHT SCREW G11-08-12U (4) CONNECTOR 58028-01-000 (2)	LAMP ASM-FLUORESCENT 12" 2 BULB W/O SWITCH THIN-LITE 
FLUN2	LAMP 91936-03-CHT SCREW G11-08-12U (4) CONNECTOR 58028-01-000 (2)	LAMP ASM-FLUORESCENT 18" 2 BULB W/O SWITCH THIN-LITE 
FLUN3	LAMP 91936-07-CHT SCREW G11-08-12U (4) CONNECTOR 58028-01-000 (2)	LAMP ASM-FLUORESCENT 12" 2 BULB W/O SWITCH THIN-LITE  CUTOUT-122 X 336
FLUN4	LAMP 91936-05-CHT SCREW G11-08-12U (6) CONNECTOR 58028-01-000 (2)	LAMP ASM-FLUORESCENT 18" 2 BULB W/O SWITCH THIN-LITE  CUTOUT-122 X 480

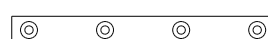
LAMP ASM-PACKAGE, MAKEUP LAMP

NO	PART NUMBER	DESCRIPTION
LMU3-1	LAMP 110235-01-CHT SCREW W/SPACER (SUPPLIED) CONNECTOR 58028-01-000 (2)	LAMP ASM-MAKEUP (W/O MIRROR) 3 BULB (SUPPLIED) PROGRESSIVE DYNAMICS 
LMM3-2	LAMP 123774-03-CHT SCREW (SUPPLIED) BULB 123918-01-000 (3) CONNECTOR 58028-01-000 (2)	LAMP ASM-MAKEUP (W/MIRROR) 3 BULB GUSTOFSON 
LMU3-2	LAMP 138116-01-CHT SCREW (SUPPLIED) BULB 123918-01-000 (3) CONNECTOR 58028-01-000 (2)	LAMP ASM-MAKEUP (W/O MIRROR) 3 BULB GUSTOFSON 
LMU4-1	LAMP 110235-02-CHT SCREW G11-08-16U (2) CONNECTOR 58028-01-000 (2)	LAMP ASM-MAKEUP (W/O MIRROR) 4 BULB PROGRESSIVE DYNAMICS 
LMU4-2	LAMP 138116-02-CHT SCREW (SUPPLIED) BULB 123918-01-000 (4) CONNECTOR 58028-01-000 (2)	LAMP ASM-MAKEUP (W/O MIRROR) 4 BULB GUSTOFSON 
LMM4-2	LAMP 123774-01-CHT SCREW G11-08-16U (2) BULB 123918-01-000 (4) CONNECTOR 58028-01-000 (2)	LAMP ASM-MAKEUP (W/MIRROR) 4 BULB GUSTOFSON 

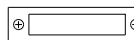
LAMP ASM-PACKAGE, OTHER

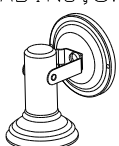
NO	PART NUMBER	DESCRIPTION
LSH-1	LAMP 121935-01-CHT SCREW G11-08-16U (4) CONNECTOR 58028-01-000 (2)	LAMP ASM-SHOWER PROGRESSIVE DYNAMICS INC. 
LCR-1	LAMP 61424-01-000 SCREW G11-08-12U (4) CONNECTOR 58028-01-000 (2)	LAMP ASM-COURTESY, AISLE RAMCO (RECTANGULAR) 
LCS-1	LAMP 108354-01-CHT SCREW G11-08-12U (4) CONNECTOR 58028-01-000 (2)	LAMP ASM-COURTESY, AISLE ITC MARINE (SQUARE) 
READ-1	LIGHT-READING 132427-01-CHT SCREW G13-06-16U (2) CLIP-U 141395-02-CHT (2) CONNECTOR 58028-01-000 (2)	LIGHT-READING, SWIVEL, ROUND 1 BULB 
READ-2	LIGHT-READING 128786-02-CHT SCREW G11-08-16J (2) BULB 123917-01-000 CONNECTOR 58028-01-000 (2)	LIGHT, READING, SWIVEL 

LEGEND

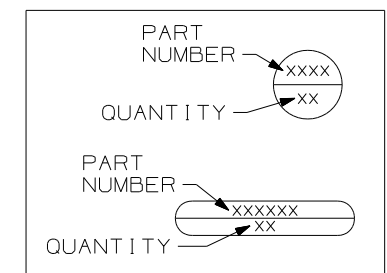

FIRST USED	96 MH'S
TITLE	DO NOT SCALE DRAWING
SHEET 4	PART NO 121339

ANTENNA ASM-PACKAGE

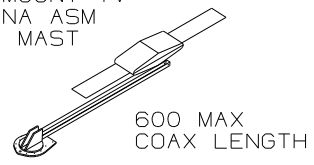
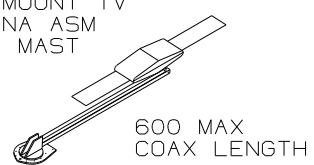
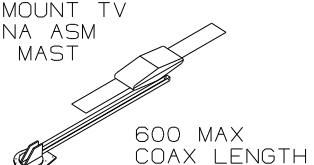
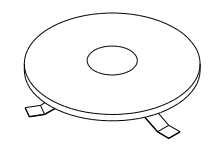
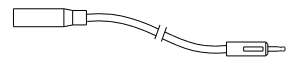
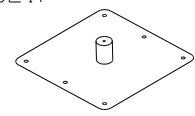
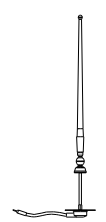
NO	PART NUMBER	DESCRIPTION
ANT-1	ANTENNA 76319-24-000 HARDWARE - INTERIOR 76319-25-000 BUMPER 69726-02-000 (2) CLIP 80734-02-000	ROOF MOUNT TV ANTENNA ASM 25.5" MAST 
ANT-2	ANTENNA 76319-23-000 HARDWARE - INTERIOR 76319-25-000 BUMPER 69726-02-000 (2) ADAPTER SUPPLIED W/ANTENNA	ROOF MOUNT TV ANTENNA ASM 44.5" MAST 
ANT-2W	ANTENNA 76319-23-000 HARDWARE - INTERIOR 76319-25-000 BUMPER 69726-02-000 (2) ADAPTER SUPPLIED W/ANTENNA WEDGE 76319-26-000	ROOF MOUNT TV ANTENNA ASM 44.5" MAST 
ANT-3	ANTENNA-TV ROOF MNT, ROUND 132935-01-000 PLATE-ROOF, CABLE ENTRY 146488-01-000 SCREW 105702-01-000 (10) CABLE ASM-COAX 87105-01-006 ADAPTER 82134-01-000	ROOF MOUNT OMNI- DIRECTIONAL ANTENNA MOUNTING SCREWS SUPPLIED WITH ANTENNA 
ANTEXT-1	CABLE ASM-EXTENS 77069-02-000	RADIO ANTENNA CABLE EXTENSION 2400MM USABLE LENGTH 
ANTKIT-1	ADAPTER-PLATE 76319-06-000 SCREW G11-08-08T (6) CLIP-WIRE 80734-02-000 SCREW G11-08-08T	PLATE ASM-ADAPTERS CABLE ROOF MOUNTING PLATE W/ CABLE-CABLE ADAPTER, FITTINGS, AND CABLE RETAINING CLIP 
ANT-R	ANTENNA-RADIO 90944-01-000 EXTENDER-SHAFT ANTENNA 109889-04-000 BRACKET-ANTENNA GROUND 147741-01-CHT	ROOF MOUNT RADIO ANTENNA 
ANTEXT-2	CABLE ASM-EXTENS 77069-03-000	RADIO ANTENNA CABLE EXTENSION 6600 MM USABLE LENGTH

SATELLITE DISH INSTL

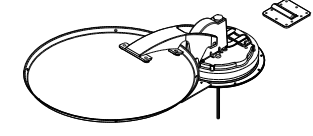
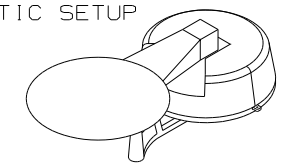
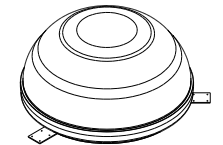
NO	PART NUMBER	DESCRIPTION
DM-1	SATELLITE DISH 137135-02-000 SCREW G67-10-12B (8) PLATE & BRACKET (SUPPLIED) SCREW G67-10-12B (10)	SATELLITE DISH ANTENNA ASM MANUAL SETUP 
DA-1	SATELLITE DISH 141454-03-CHT SCREW G67-10-12B (16) PLATE & BRACKET (SUPPLIED) SCREW G67-10-12B (10)	SATELLITE DISH ANTENNA ASM AUTOMATIC SETUP 
D1-1	SATELLITE DISH 144377-01-000 SCREW G39-10-12B (18)	SATELLITE DISH ANTENNA ASM IN MOTION SETUP 

SENSORS

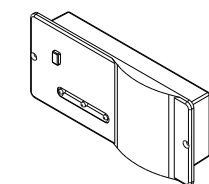
NO	PART NUMBER	DESCRIPTION
LPGD	LP GAS DETECTOR 150138-01-CHT SCREW G68-06-10U (2)	DETECTOR-LP GAS 

PANELS

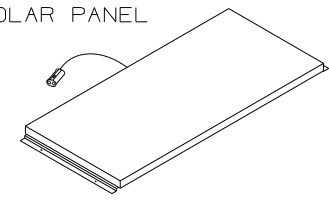
NO	PART NUMBER	DESCRIPTION
SOLAR	PANEL-SOLAR 10 WATT 151647-01-000 SCREW G11-08-12U (4)	SOLAR PANEL 

LEGEND

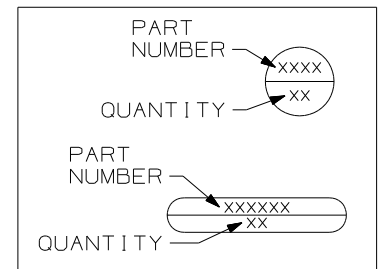

FIRST USED	96 MH'S
TITLE	DO NOT SCALE DRAWING
TITLE	PART LISTING-ELECTRICAL
SHEET 5	PART NO 121339

RECEPTACLE PACKAGE - GF I

SPACERS

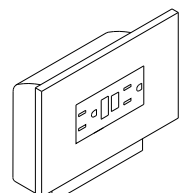
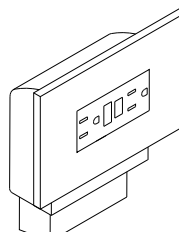
NO	PART NUMBER	DESCRIPTION
GF1 US	RECEPTACLE 147446-01-CHT BOX 91910-02-000 PLATE-OUTLET 147450-01-CHT WIRE-BONDING 133678-03-000 SCREW G13-07-12B (4) CONNECTOR 8313-01-000	GF1 RECEPTACLE WITH COVER AND BOX FOR US APPLICATION 
GF1 CAN	RECEPTACLE 147446-01-CHT BOX 91910-01-000 PLATE-OUTLET 147450-01-CHT WIRE-BONDING 133678-03-000 SCREW G13-07-12B (4) CONNECTOR 8313-01-000	GF1 RECEPTACLE WITH COVER AND BOX FOR CANADA APPLICATION 

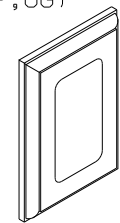
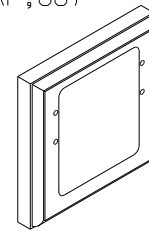
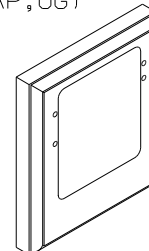
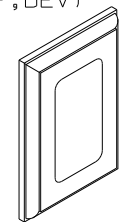
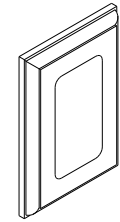
NO	PART NUMBER	DESCRIPTION
SP-01	SPACER 102568-01-XXX	STANDARD 110V RECEPTACLE SPACER (WOOD,VYL RAP,OG) 
SP-02	SPACER 102568-02-XXX	WOOD SPACER FOR CEILING MOUNTED A/C PREP BOX (US) (WOOD,VYL RAP,OG) 
SP-03	SPACER 102568-03-XXX	WOOD SPACER FOR CEILING MOUNTED A/C PREP BOX (CANADA) (WOOD,VYL RAP,OG) 
SP-04	SPACER 133713-01-CHT	STANDARD 110V RECEPTACLE SPACER (WOOD,VYL RAP,BEV) 
SP-05	SPACER 133713-20-XXX	STANDARD 110V RECEPTACLE SPACER (WOOD,BEV) 

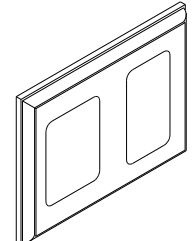
SP-21	SPACER 126052-01-XXX	WOOD SPACER FOR 1 - 110V RECEPTACLE AND 1 - REAR TV (12V) JACK (WOOD,BEV) 
-------	-------------------------	---

RECEPTACLE PACKAGE - GF I

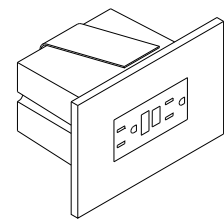
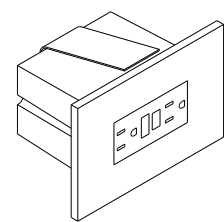
NO	PART NUMBER	DESCRIPTION
GF1-L US	RECEPTACLE 147446-01-CHT BOX 133070-01-000 PLATE-OUTLET 147450-01-CHT WIRE-BONDING 133678-03-000 SCREW G13-07-12B (4) CONNECTOR 8313-01-000	GF1 RECEPTACLE WITH COVER AND BOX FOR US APPLICATION 
GF1-L CAN	RECEPTACLE 147446-01-CHT BOX 133070-02-000 PLATE-OUTLET 147450-01-CHT WIRE-BONDING 133678-03-000 SCREW G13-07-12B (4) CONNECTOR 8313-01-000	GF1 RECEPTACLE WITH COVER AND BOX FOR CANADA APPLICATION 

LEGEND

MISC.	SPACER
PART NUMBER → XXXX LISTING → XXX	XXXX → PART NUMBER

FIRST USED	96 MH'S
TITLE	DO NOT SCALE DRAWING
	PART LISTING-ELECTRICAL
SHEET 6	PART NO 121339

PREP - A/C, RECESSED (W/OUT FACTORY A/C)

NO	PART NUMBER	DESCRIPTION
PREP A/C-US	BOX 91910-02-000	BOX AND EQUIPMENT USED FOR A/C PREP (W/OUT FACTORY A/C). US APPLICATION (RECESSED IN ROOF)
	COVER 84099-02-CHT	
	LABEL 91243-01-000	
	SCREW G13-07-12B (4)	
	CONNECTOR 8313-01-000 (3)	
PREP A/C-CAN	BOX 91910-01-000	BOX AND EQUIPMENT USED FOR A/C PREP (W/OUT FACTORY A/C). CANADA APPLICATION (RECESSED IN ROOF)
	COVER 84099-02-CHT	
	LABEL 91243-01-000	
	SCREW G13-07-12B (4)	
	CONNECTOR 8313-01-000 (3)	

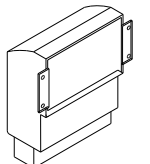
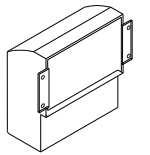

CONNECTION BOX, GENERATOR SERVICE FEED

NO	PART NUMBER	DESCRIPTION
J-GEN 30	BOX 8289-01-000	BOX AND EQUIPMENT USED FOR CONNECTING THE GENERATOR LEADS TO THE SERVICE ENTRANCE WIRES (US & CA APPLICATION)
J-GEN 30-US	COVER 8294-01-000	
J-GEN 30-CA	SCREW G67-10-10B (2)	
	WIRE ASM-GROUND 133678-02-000	
	WIRE NUT-GREY 8314-01-000 (3)	
	SCREW-GRND 103291-01-000	
	CONNECTOR-WIRE 8356-01-000	

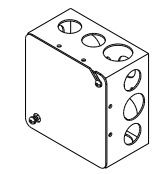

PREP - A/C, SURFACE (W/OUT FACTORY A/C)

NO	PART NUMBER	DESCRIPTION
PREP SURF	BOX 93603-01-000	SURFACE MOUNT, US AND CANADA, BOX AND EQUIPMENT FOR A/C PREP (W/OUT FACTORY A/C). TYPICALLY LOCATED ON OVERHEAD CABINET INNER WALL OR ON CEILING.
	COVER 53337-01-000	
	LABEL 91243-01-000	
	SCREW-GRND 103291-01-000	
	WIRE-BONDING 8019-01-000	
	SCREW G11-08-12B (2)	
	TERMINAL 8328-01-000	
	CONNECTOR 8313-01-000 (2)	
	CONNECTOR 8311-01-000	

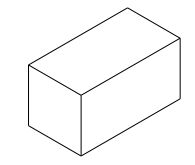

CONNECTION BOX-POWER CORD

NO	PART NUMBER	DESCRIPTION
J-PC 30	BOX 8289-01-000	CONNECTION BOX IN POWER CORD COMPT FOR POWER CORD (US & CA APPLICATION)
	COVER 8294-01-000	
J-PC 30-US	SCREW G67-10-10B (2)	
	WIRE ASM-GROUND 133678-02-000	
J-PC 30-CA	CONNECTOR 8314-01-000 (3)	
	SCREW-GRND 103291-01-000	
	CONNECTOR 8356-02-000	
	CONNECTOR (PC) 8355-01-000	

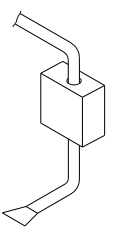

CONNECTION BOX-GENERATOR RECEPTACLE

NO	PART NUMBER	DESCRIPTION
J-RCP 30	BOX 8289-01-000	CONNECTION BOX IN POWER CORD COMPT FOR THE GENERATOR RECEPTACLE (US & CA APPLICATION)
	RECEPTACLE 24924-02-000	
J-RCP 30-US	COVER 69238-01-000	
	SCREW G67-10-10B (2)	
J-RCP 30-CA	WIRE ASM-GROUND 133678-02-000	
	133678-04-000	
	SCREW-GRND 103291-01-000	
	CONNECTOR 8314-01-000	

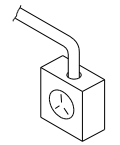

LEGEND

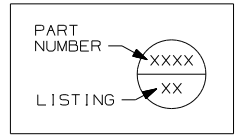

FIRST USED	96 MH'S
TITLE	DO NOT SCALE DRAWING
	PART LISTING-ELECTRICAL
SHEET 7	PART NO 121339

CODE/COLOR	FROM:	WIRE IDENTIFICATION CHART TO:
A 14 YEL	GALLEY CEILING LAMP SWITCH	GALLEY CEILING LAMP
B 12 YEL	OVERCURRENT PROTECTION (30A BREAKER TYPICAL)	POWER PASSENGER SEAT ("BUDDY SEAT")
C 12 WHT	POWER PASSENGER SEAT	GROUND
D 14 YEL	SHOWER OVHD LAMP SWITCH SEE WIRE PF, START OF 97	SHOWER OVHD LAMP
E 095038-01-	PHONE INPUT JACK	REAR PHONE JACK
F 095038-01-	PHONE INPUT JACK	EXTERIOR PHONE JACK
G 12/ 10 YEL	OVERCURRENT PROTECTION (30A BREAKER TYPICAL)	HIGH SPEED HEATER FAN (USE 10 IF OVER 6' RUN)
H 095038-01-	PHONE INPUT JACK	FRONT PHONE JACK
J 6 BLK	OVERCURRENT PROTECTION (45 OR 55A BREAKER TYP)	COACH 12V PANEL/ CONVERTER BATTERY CHARGE
K 6 BLK	OVERCURRENT PROTECTION (45 OR 55A BREAKER TYP)	COACH 12V PANEL
L 6 GRN	CONVERTER 45 OR 55 AMP	GROUND
M 6 BLK	OVERCURRENT PROTECTION (45 OR 50A BREAKER)	CONVERTER BATTERY CHARGE
N 10 WHT	REFRIGERATOR	GROUND
P 10YEL(BLK)	OVERCURRENT PROTECTION (20A FUSE TYPICAL)	REFRIGERATOR (3 WAY)
R 8 GRN	REFRIGERATOR CHASSIS	GROUND
S 8 OR 6 GRN	GROUND BAR (LEFT SIDE)	CHASSIS GROUND
T 8 OR 6 GRN	GROUND BAR (RIGHT SIDE)	CHASSIS GROUND
U 6 GRN	CONVERTER CHASSIS	GROUND
W 8 GRN	- GROUND STUD	- GROUND STUD

CODE/COLOR	FROM:	WIRE IDENTIFICATION CHART TO:
X 14 YEL	- CHASSIS BRAKE LAMP CIRCUIT	- CENTER MOUNT BRAKE LAMP
Y 16 YEL	VOLUME CONTROL	RADIO/TV SPEAKER
Z 6 BLK	OVERCURRENT PROTECTION (45 OR 55A BREAKER TYP)	COACH 12V PANEL
AA 16 WHT	SERVICE ENGINE SOON LAMP	VEHICLE SERVICE ENGINE SOON LAMP CIRCUIT
AB 16 WHT	WATER TANK LEVEL SENSORS	GROUND
AC 16 WHT	MAIN HOLDING TANK SENSORS (BLACK WATER)	GROUND
AD 16 WHT	AUXILIARY HOLDING TANK #1 (GRAY WATER)	GROUND
AE 16 WHT	AUXILIARY HOLDING TANK #2 (GRAY WATER)	GROUND
AF 12 YEL	WATER PUMP SWITCH #1	MONITOR PANEL WATER PUMP SWITCH
AG 12 YEL	WATER PUMP SWITCH #1	MONITOR PANEL WATER PUMP SWITCH
AH 14 YEL	OVERCURRENT PROTECTION (10A FUSE TYPICAL)	BRAKE LAMP SWITCH WARNING LAMP (IGNITION RUN/START FED)
AJ 12 WHT	CHASSIS GROUND	BODY GROUND
AK 12 WHT	CHASSIS GROUND	BODY GROUND
AL 12 YEL	HEATER CONTROL (LOW SPEED)	BLOWER MOTOR (LOW SPEED)
AM 12YEL(WHT)	HEATER CONTROL (MEDIUM/LOW SPEED)	BLOWER MOTOR (MEDIUM/LOW SPEED)
AN 12 YEL	HEATER CONTROL (MEDIUM/HIGH SPEED)	BLOWER MOTOR (MEDIUM/HIGH SPEED)
AP 14 YEL	IGNITION SWITCH ACCESSORY FEED	OVERCURRENT PROTECTION (15A FUSE TYPICAL)
AR 14 WHT	HORN, FOG LAMPS	GROUND
AS 16 WHT	DASH RADIO	RIGHT FRONT SPEAKER (NEGATIVE)

CODE/COLOR	FROM:	WIRE IDENTIFICATION CHART TO:
AT 16 WHT	DASH RADIO	LEFT FRONT SPEAKER (NEGATIVE)
AU 16 YEL	OVERCURRENT PROTECTION (15A BREAKER TYPICAL)	FRONT CARGO LAMP SWITCH (IGNITION ACCESSORY FED)
AW 16 YEL	FRONT CARGO LAMP SWITCH	REAR CARGO LAMP SWITCH
AX 16 YEL	FRONT CARGO LAMP SWITCH	REAR CARGO LAMP SWITCH
AY 16 YEL	REAR CARGO LAMP SWITCH	CARGO LAMPS
BA 14 WHT	WINDSHIELD WIPER MOTOR	GROUND
BB 16 YEL	OVERCURRENT PROTECTION (6A BREAKER TYPICAL)	INSTRUMENT PANEL GAUGES (IGNITION ACCESSORY FED)
BC 14 WHT	INDICATOR LAMPS	GROUND
BD 14 YEL	OVERCURRENT PROTECTION (10A FUSE TYPICAL)	BRAKE LAMP SWITCH
BE 12 WHT	BLOWER MOTOR	GROUND
BF 14 WHT	WASHER BOTTLE PUMP/HORN	GROUND
BG 14 YEL	FUEL SENDER	FUEL GAUGE
BH 14 YEL	RUN ONLY POWER RELAY	ENGINE WIRING
BJ 16 YEL	OVERCURRENT PROTECTION (10A FUSE TYPICAL)	ENGINE WIRING (IGNITION RUN/START FED)
BK 14 YEL	OVERCURRENT PROTECTION (10A FUSE TYPICAL)	HORN RELAY FEED
BL 16 WHT	CIGAR LIGHTER	GROUND
BM 16 YEL	CHASSIS BATTERY POWER	CIGAR LIGHTER
BN 16 YEL	ACCESSORY POWER	SPOTLAMP
BP 14 WHT	POWER MIRROR	GROUND

CODE/COLOR	FROM:	WIRE IDENTIFICATION CHART TO:
BR 14 YEL	POWER MIRROR (RIGHT SIDE)	POWER MIRROR CONTROL SWITCH
BS 14 YEL	POWER MIRROR HEAT SWITCH	POWER MIRRORS
BT 14 YEL	POWER MIRROR (LEFT SIDE)	POWER MIRROR CONTROL SWITCH
BU 14 YEL	RUN ONLY POWER	POWER MIRROR HEAT/ CONTROL SWITCHES
BW 12 YEL	IGNITION SWITCH	ACCESSORY CIRCUIT FEED
BX 12YEL(ORN)	IGNITION SWITCH RUN ONLY SOURCE	GENERAL(TURN, BACK UP,DASH IGNITION CIRCUIT,ETC)
BY 12YEL/8BLK	OVERCURRENT PROTECTION (16GA FUSELINK)(8GA PASSTHRU)	CHASSIS BATTERY SOURCE(AUTO AC BLOWER,POWER DRIVER SEAT,ETC)
CA 12 YEL	OVERCURRENT PROTECTION (16GA FUSELINK TYPICAL)	CHASSIS BATTERY SOURCE
CB 12 YEL	IGNITION SWITCH START SOURCE	START CIRCUIT SOURCE
CC 16 YEL	ALTERNATOR	ALTERNATOR WARNING LAMP
CD 16 YEL	OIL PRESSURE WARNING SENDER	OIL PRESSURE WARNING LAMP
CE 16 YEL	WATER TEMPERATURE WARNING SENDER	WATER TEMPERATURE WARNING LAMP
CF 14 YEL	REAR TV JACK	POWER FEED SWITCH
CG 14 YEL	CLUTCH/NEUTRAL SWITCH	START ISOLATION RELAY
CH 14 YEL	START RELAY	ENGINE WIRING
CJ 14 YEL	WINDSHIELD WIPER/WASHER CONTROL SWITCH	WINDSHIELD WASHER PUMP
CK 16 YEL	TELEVISION	SPEAKER (POSITIVE)
CL 16 WHT	TELEVISION	SPEAKER (NEGATIVE)
CM 10 YEL	OVERCURRENT PROTECTION (15A BREAKER TYPICAL)	INVERTER FEED

CODE/COLOR	FROM:	WIRE IDENTIFICATION	CHART TO:
CN 10 WHT	INVERTER		GROUND
CP 12 WHT	INVERTER CHASSIS		GROUND
CR 16 WHT	VEHICLE CHECK ENGINE LAMP CIRCUIT	CHECK ENGINE LAMP	
CS 16 WHT	REMOTE THERMOSTAT (RC TERM/ORG EXPORT AIR)		GROUND
CT 16 YEL	DAYTIME RUNNING LAMP MODULE OUTPUT(PIN 30)		LOW BEAM HEADLAMP CIRCUIT
CU 16 YEL	DAYTIME RUNNING LAMP MODULE ENABLE(PIN 85)		RUN/START CIRCUIT
CW 14 YEL	DAYTIME RUNNING LAMP MODULE POWER(PIN 87A)		CHASSIS BATTERY POWER
CX 16 WHT	DAYTIME RUNNING LAMP MODULE GROUND(PIN 87)		GROUND
CY 16 YEL	DAYTIME RUNNING LAMP MODULE HIGH BEAM DISABLE(PIN 86)		HIGH BEAM HEADLAMP CIRCUIT
DA 12 YEL	SHOWER SUMP SYSTEM PUMP SWITCH	SHOWER SUMP SYSTEM PUMP	
DB 12 WHT	SHOWER SUMP SYSTEM PUMP		GROUND
DC 16 YEL	REAR ROOF AIR CONDITIONER EXHAUST CIRCUIT		THERMOSTAT
DD 16 YEL	REAR ROOF AIR CONDITIONER COOL CIRCUIT	THERMOSTAT (Y TERM-EXPORT AIR/YEL)	
DE 16 YEL	REAR ROOF AIR CONDITIONER HIGH SPEED FAN CIRCUIT	THERMOSTAT (H TERM-EXPORT AIR/BLU)	
DF 16 YEL	REAR ROOF AIR CONDITIONER LOW SPEED FAN CIRCUIT	THERMOSTAT (G TERM-EXPORT AIR/RED)	
DG 12YEL(GRY)	IGNITION SWITCH		ACCESSORY/RUN FEED
DH 14 YEL	EMERGENCY SHUTDOWN GAUGE	FUEL SOLENOID (DIESEL ENGINE)	
DJ 16 YEL	TV/RADIO SPEAKER SWITCHING RELAY OUTPUT	LEFT REAR SPEAKER POSITIVE	
DK 16 WHT	TV/RADIO SPEAKER SWITCHING RELAY OUTPUT	LEFT REAR SPEAKER NEGATIVE	

CODE/COLOR	FROM:	WIRE IDENTIFICATION	CHART TO:
DL 16 YEL	TV/RADIO SPEAKER SWITCHING RELAY OUTPUT		RIGHT REAR SPEAKER POSITIVE
DM 16 WHT	TV/RADIO SPEAKER SWITCHING RELAY OUTPUT		RIGHT REAR SPEAKER NEGATIVE
DN 10 YEL	BATTERY DISCONNECT RELAY		CIRCUIT BREAKER SLIDEOUT ROOM CIRCUIT BRKR
DP 14 YEL	TV/RADIO SPEAKER FEED SELECT SWITCH		TV/RADIO SPEAKER SWITCHING RELAY COIL INPUT OR AMPLIFIER
DR 16 YEL	SLIDEOUT ROOM SWITCH (ROOM ONE EXTEND)		HWH WIRING (ROOM ONE EXTEND)
DS 10 WHT	SLIDEOUT ROOM CONTROL SWITCH		GROUND
DT 16 YEL	SLIDEOUT ROOM RELAY (PIN 30)		SLIDEOUT ROOM CONTROL SWITCH
DU 16 YEL	SLIDEOUT ROOM SWITCH(G OR M) (ROOM ONE RETRACT)		HWH WIRING (ROOM ONE RETRACT)
DW 16 WHT	SLIDEOUT ROOM SWITCH (G) (SWITCHED GROUND TO PUMP)		HWH WIRING (SWITCHED GROUND TO PUMP)
DX 16 WHT	HWH WIRING (G) (GROUND)		SLIDEOUT ROOM SWITCH (GROUND)
DY 16 WHT	HWH WIRING (G) (JACK SENSE; SWITCHED GROUND)		SLIDEOUT ROOM RELAY (JACK SENSE; SWITCHED GROUND)
EA 16 YEL	HWH WIRING (G) (ACCESSORY POWER)		SLIDEOUT ROOM RELAY (ACCESSORY POWER)
EB 16 YEL	SLIDEOUT ROOM RELAY (G) (SWITCHED ACCESSORY POWER)		FRT/RR SLIDEOUT ROOM SWITCH (SWITCHED EXTEND/RETRACT PWR)
EC 10 YEL	CHASSIS BATTERY POWER SOURCE (BATTERY MODE SOLENOID POST)		THRU FUSE TO AMP SOURCE SELECT RELAY(PIN 87)(OPTION 21V,95 Q)
ED 10 YEL	COACH BATTERY POWER SOURCE (BATTERY MODE SOLENOID POST)		THRU FUSE TO AMP SOURCE SELECT RELAY(PIN 87A)(OPTION 21V,95Q)
EE 16 YEL	AIR RIDE SUSPENSION LEFT DOWN SWITCH POSITION		AIR RIDE SUSPENSION LEFT HEIGHT CONTROL BOX
EF 16 YEL	AIR RIDE SUSPENSION LEFT UP SWITCH POSITION		AIR RIDE SUSPENSION LEFT HEIGHT CONTROL BOX
EG 16 WHT	AIR RIDE SUSPENSION WIRE ASM GROUND		AIR RIDE SUSPENSION CONTROL LAMP GROUNDS
EH 16 YEL	AIR RIDE SUSPENSION RIGHT DOWN SWITCH POSITION		AIR RIDE SUSPENSION RIGHT HEIGHT CONTROL BOX

CODE/COLOR	FROM:	WIRE IDENTIFICATION CHART TO:
EJ 16 YEL	AIR RIDE SUSPENSION RIGHT UP SWITCH POSITION	AIR RIDE SUSPENSION RIGHT HEIGHT CONTROL BOX
EK 16 YEL	AIR RIDE SUSPENSION AUTO MODE SWITCH POSITION	AIR RIDE SUSPENSION HEIGHT CONTROL BOXES
EL 16 YEL	RUN ONLY POWER	AIR RIDE SUSPENSION AUTO/MANUAL MODE SWITCH
EM 16 YEL	AIR RIDE SUSPENSION COMPRESSOR	COMPRESSOR ON WARNING LAMP
EN 16 YEL	AIR RIDE SUSPENSION MANUAL MODE SWITCH POSITION	LEVEL CONTROL SWITCHES AND INDICATOR LAMP
EP 14 YEL	OVERCURRENT PROTECTION (15A BREAKER TYPICAL)	SPOTLAMP
ER 16 YEL	OVERCURRENT PROTECTION (6A BREAKER TYPICAL)	ELECTRIC STEP KILL SWITCH
ES 16 YEL	ELECTRIC STEP KILL SWITCH	ELECTRIC STEP
ET 16 YEL	OVERCURRENT PROTECTION (6A BREAKER TYPICAL)	REFRIGERATOR (2 WAY)
EU 16 WHT	REFRIGERATOR (2 WAY)	GROUND
EW 14 YEL	FUEL HEATER SWITCH	FUEL HEATER (DIESEL ENGINE)
EX 14 YEL	TELEVISION POWER SWITCH	TELEVISION WALL PLATE
EY 12YELLTBLU	OVERCURRENT PROTECTION (16GA FUSELINK TYPICAL)	IGNITION SWITCH FEED #2
FA 14 YEL	DRIVER'S DOOR PASSENGER SIDE POWER WINDOW SWITCH(DOWN,PIN2)	PASSENGER'S POWER WINDOW SWITCH(PIN 2)
FB 14 YEL	DRIVER'S DOOR PASSENGER SIDE POWER WINDOW SWITCH(UP,PIN 4)	PASSENGER'S POWER WINDOW SWITCH(PIN 4)
FC 14 YEL	PASSENGER'S DOOR POWER WINDOW SWITCH(DOWN,PIN 1)	PASSENGER'S DOOR POWER WINDOW MOTOR(DOWN)
FD 14 YEL	PASSENGER'S DOOR POWER WINDOW SWITCH(UP,PIN 5)	PASSENGER'S DOOR POWER WINDOW MOTOR(UP)
FG 10 YEL	AMPLIFIER POWER SOURCE SELECT RELAY (PIN 30)	AMPLIFIER POWER FEED (DELUXE SOUND SYSTEM,95 LUXOR)
FH 10 WHT	AMPLIFIER (DELUXE SOUND SYSTEM,95 LUXOR)	GROUND

CODE/COLOR	FROM:	WIRE IDENTIFICATION CHART TO:
FJ 12 YEL	WATER PUMP SWITCH #2 (THREE SWITCH SYSTEM)	WATER PUMP SWITCH #1 (THREE SWITCH SYSTEM)
FK 12 YEL	WATER PUMP SWITCH #2 (THREE SWITCH SYSTEM)	WATER PUMP SWITCH #1 (THREE SWITCH SYSTEM)
FL 14 YEL	SECOND PORCH LAMP SWITCH	SECOND PORCH LAMP
FM 14 WHT	SOLENOID MOUNTING BOLT	GROUND
FN 16 YEL	SOURCE SELECTOR SWITCH (DELUXE SOUND SYSTEM,95 LUXOR)	AMP & EQUALIZER REMOTE TRIGGER (DELUXE SOUND SYSTEM,95 LUXOR)
FP 16 YEL	EXHAUST BRAKE SWITCH (DIESEL PUSHER CHASSIS)	CHASSIS EXHAUST BRAKE HARNESS & BRAKE ON DASH INDICATOR LAMP
FR 14 YEL	FORD RUN/ACCESSORY IGNITION CIRCUIT(WHT/PUR,10A FUSED)	DOCKING LAMPS, RELAY TRIGGER, REAR MONITOR CAMERA FEED
FS 14 YEL	DOCKING LAMPS RELAY(PIN 87)	DOCKING LAMPS
FT 14 WHT	DOCKING LAMPS	GROUND
FU 14 YEL	AUTOMOTIVE AIR WIRING	FORD A/C COMPRESSOR CLUTCH SWITCH CIRCUIT
FW 14 YEL	DOCKING LAMPS SWITCH	DOCKING LAMPS RELAY(PIN 30)
FX 12 YEL	OVERCURRENT PROTECTION (30A BRKR OR FUSE)	POWER DRIVER SEAT (I.E.,6 WAY)
FY 12 WHT	POWER DRIVER SEAT (I.E.,6 WAY)	GROUND
GA 14 YEL	WATER SYSTEM WINTERIZATION SWITCH	WINTERIZATION VALVE
GB 14 YEL	WATER HEATER BYPASS SWITCH	WATER HEATER BYPASS VALVE
GC 16 YEL	SLIDEOUT ROOM SPDT SWITCH (M) (SWITCHED WIRE)	HWH WIRING (SWITCHED WIRE)
GD 16 YEL	WIPER CONTROL MODULE	WIPER MOTOR (S TERMINAL)
GE 16 YEL	SWITCHED DOME LAMP FEED	DOME LAMP
GF 16 WHT	COMMON REAR CHANNEL SPEAKER RETURN	REAR SPEAKERS

CODE/COLOR	FROM:	WIRE IDENTIFICATION CHART TO:
GG 16 YEL	RADIO REMOTE TRIGGER (DELUXE SOUND OPTION)	SOURCE SELECTOR SWITCH (LUXOR)
GH 14 WHT	GLOW PLUG WAIT LAMP (DIESEL ENGINE)	ENGINE SENDER
GJ 16 YEL	COACH BATTERY POWER (UPSTREAM OF DISCONNECT)	LP DETECTOR AND/OR SOLAR PANEL WIRING OVERCURRENT PROTECTION
GK 14 YEL	AIR HORN SWITCH	CHASSIS HORN
GL 16 WHT	WATER/HOLDING TANKS LEVEL SENSORS	GROUND
GM 16 YEL	JET AIR RIDE SUSPENSION PRESSURE SENSORS	CHECK REAR AIR SUSPENSION DASH WARNING LAMP
GN 16 YEL	REAR TV SPEAKER OUTPUT (POSITIVE)	REAR TV SPEAKER (POSITIVE)
GP 16 WHT	REAR TV SPEAKER OUTPUT (NEGATIVE)	REAR TV SPEAKER (NEGATIVE)
GR 14 YEL	THERMOSTATICALLY CONTROLLED ROOF VENT (SEND)	THERMOSTAT (RETURN)
GS 14 YEL	THERMOSTATICALLY CONTROLLED ROOF VENT (RETURN)	THERMOSTAT (RETURN)
GT 16 YEL	RADIO POWER SWITCH (MEMORY FEED)	RADIO (MEMORY FEED)
GU 16 YEL	DEFOG MODULE OUTPUT	DEFOG RELAY, INDICATOR LAMP
GW 16 WHT	DEFOG SWITCH ON/OFF	DEFOG MODULE ON/OFF
GX 16/12 WHT	STEP COVER SWITCH (REF AAA-16/KA-12)	GROUND
GY 12 YEL	DEFOG RELAY	DEFOG UNIT
HA 14 YEL	READING LAMPS SWITCH (93 VANS)	READING LAMPS
HB 14 YEL	"MOOD" LAMPS SWITCH (93 VANS)	"MOOD" LAMPS
HC 14 YEL	12V POWER SOURCE (93 VANS)	OVERCURRENT PROTECTION (15A FUSE TYPICAL)
HD 14 YEL	SOFA SLIDE MOTOR POSITIVE (94 VANS)	SOFA MONOPLEX CONTROLLER

CODE/COLOR	FROM:	WIRE IDENTIFICATION CHART TO:
HE 14 WHT	SOFA SLIDE MOTOR NEGATIVE (94 VANS)	SOFA MONOPLEX CONTROLLER
HF 14 YEL	SOFA RECLINE MOTOR POSITIVE (94 VANS)	SOFA MONOPLEX CONTROLLER
HG 14 WHT	SOFA RECLINE MOTOR NEGATIVE (94 VANS)	SOFA MONOPLEX CONTROLLER
HH 16 YEL	SOFA MONOPLEX SWITCH (94 VANS)	SOFA MONOPLEX CONTROLLER
HJ 16 WHT	SOFA MONOPLEX SWITCH (94 VANS)	GROUND
HK 14 WHT	SOFA MONOPLEX CONTROLLER (94 VANS)	GROUND
HL 14 YEL	FLOOD LAMP SWITCH (94 VANS)	FLOOD LAMP
HM 16 YEL	REAR TV SPEAKER OUTPUT (POSITIVE)	REAR TV SPEAKER (POSITIVE)
HN 16 WHT	REAR TV SPEAKER OUTPUT (NEGATIVE)	REAR TV SPEAKER (NEGATIVE)
HP 16 YEL	OVERCURRENT PROTECTION (94 VANS)	REAR AC
HR 14 YEL	SWITCH (94 1200 MODEL VAN)	12VOLT RECEPTACLE
HS 16 YEL	SOLAR PANEL (1HS INDICATOR TO BATTERY)	COACH BATTERY THRU OVERCURRENT PROTECTION
HT 16 WHT	SOLAR PANEL (1HT INDICATOR TO GROUND)	GROUND
HU 16 YEL	GENERATOR SWITCH (LED)	GENERATOR (POSITION B)
HW 16 YEL	LICENSE PLATE LAMP FEED	LICENSE PLATE LAMP
HX 16 YEL	CHASSIS CLEARANCE LAMP CRT #2	CLEARANCE/MARKER LAMPS
HY 12 WHT	DEFOG UNIT	GROUND
JA 14 YEL	OVERCURRENT PROTECTION (15A FUSE/BREAKER TYPICAL)	WATER PUMP, MONITOR PANEL, ETC ("CLEAN CIRCUIT", REF JP)
JB 14 YEL	OVERCURRENT PROTECTION (15A FUSE/BREAKER TYPICAL)	FURNACE, ROOF VENT, ETC (REF JM)

CODE/COLOR	FROM:	WIRE IDENTIFICATION CHART TO:
JC 14 YEL	OVERCURRENT PROTECTION (15A FUSE/BREAKER TYPICAL)	COACH LIGHTING, ETC CIRCUIT #1 (REF NC)
JD 14 YEL	OVERCURRENT PROTECTION (15A FUSE/BREAKER TYPICAL)	COACH LIGHTING, ETC CIRCUIT #2 (REF ND)
JE 14 YEL	OVERCURRENT PROTECTION (15A FUSE/BREAKER TYPICAL)	COACH LIGHTING, ETC CIRCUIT #3 (REF NE)
JF 14 YEL	OVERCURRENT PROTECTION (15A FUSE/BREAKER TYPICAL)	COACH LIGHTING, ETC CIRCUIT #4 (REF NF)
JG 14 YEL	OVERCURRENT PROTECTION (15A FUSE/BREAKER TYPICAL)	COACH LIGHTING, ETC(ALT CLEAN) CIRCUIT #5 (REF JN)
JH 14 YEL	MAIN FURNACE (12V POWER)	MAIN FURNACE THERMOSTAT
JJ 14 YEL	MAIN FURNACE (HEAT)	MAIN FURNACE THERMOSTAT
JK 14 YEL	AUXILIARY FURNACE	AUXILIARY FURNACE THERMOSTAT
JL 14 YEL	AUXILIARY FURNACE	AUXILIARY FURNACE THERMOSTAT
JM 14 WHT	MAIN FURNACE	GROUND
JN 14 WHT	COACH LIGHTING CIRCUIT #5 (REF JG)	GROUND(ALTERNATE CLEAN CIRCUIT FOR LINEAR CONVERTER)
JP 14 WHT	"CLEAN CIRCUIT" DEVICES (REF JA)	GROUND
JR 16 YEL	MONITOR PANEL	LP TANK #2 LEVEL SENSOR
JS 12 YEL	MONITOR PANEL WATER PUMP SWITCH	WATER PUMP
JT 16 YEL	MONITOR PANEL	LP TANK #1 LEVEL SENSOR
JU 14 YEL	MONITOR PANEL WATER HEATER SWITCH	WATER HEATER (BLU)
JW 14 YEL	MONITOR PANEL WATER HEATER SWITCH	WATER HEATER (BRN)
JX 14 WHT	WATER HEATER	GROUND
JY 12 WHT	WATER PUMP	GROUND

CODE/COLOR	FROM:	WIRE IDENTIFICATION CHART TO:
KA 12 YEL	OVERCURRENT PROTECTION (25A BREAKER TYPICAL)	ELECTRIC STEP BATTERY POWER
KB 10 YEL	OVERCURRENT PROTECTION (25A BREAKER TYPICAL)	ELECTRIC STEP KILL SWITCH (OLD STEP WIRING STYLE)
KC 10 YEL	ELECTRIC STEP KILL SWITCH (OLD STEP WIRING STYLE)	ELECTRIC STEP
KD 18 WHT	ELECTRIC STEP DOOR JAMB SWITCH	ELECTRIC STEP
KE 14 YEL	RUN ONLY POWER SOURCE	GENERAL PURPOSE(RELAY TRIGGER, REAR AUTO HTR,DRL,MONITOR,ETC)
KF 16 WHT	COACH BATTERY DISCONNECT RELAY SWITCH	GROUND
KG 14 YEL	POWER LIFT VENT (BLU)	POWER LIFT SWITCH(UP)
KH 14 YEL	POWER LIFT VENT (RED)	POWER LIFT SWITCH(DOWN)
KJ 14 YEL	POWER LIFT VENT (BLK)	FAN SWITCH
KK 16 YEL	REAR STEREO	RIGHT SPEAKER (POSITIVE)
KL 16 WHT	REAR STEREO	RIGHT SPEAKER (NEGATIVE)
KM 14 YEL	POWER LIFT VENT LAMP	LAMP SWITCH
KN 16 YEL	REAR STEREO	LEFT SPEAKER (POSITIVE)
KP 16 WHT	REAR STEREO	LEFT SPEAKER (NEGATIVE)
KR 14 WHT	REAR STEREO ANTENNA	GROUND
KS 14 YEL	REAR AUTO HEATER SWITCH (HIGH SPEED)	REAR AUTO HEATER
KT 14 YEL	REAR AUTO HEATER SWITCH (MEDIUM SPEED)	REAR AUTO HEATER
KU 14 YEL	REAR AUTO HEATER SWITCH (LOW SPEED)	REAR AUTO HEATER
KW 16 YEL	DASH RADIO	RIGHT FRONT SPEAKER (POSITIVE)

CODE/COLOR	FROM:	WIRE IDENTIFICATION CHART TO:
KX 16 YEL	DASH RADIO	RIGHT REAR SPEAKER (POSITIVE)
KY 16 YEL	DASH RADIO	LEFT FRONT SPEAKER (POSITIVE)
LA 16 YEL	DASH RADIO	LEFT REAR SPEAKER (POSITIVE)
LB 16 WHT	DASH RADIO	RIGHT REAR SPEAKER (NEGATIVE)
LC 16 WHT	DASH RADIO	LEFT REAR SPEAKER (NEGATIVE)
LD 14 YEL	IGNITION SWITCH ACCESSORY POWER SOURCE	GENERAL PURPOSE(AUX FANS,RELAY TRIGGER,ETC.)
LE 14 YEL	AUXILIARY DEFROST FANS SWITCH (HIGH SPEED)	AUXILIARY DEFROST FANS (BLK)
LF 14 YEL	AUXILIARY DEFROST FANS SWITCH (LOW SPEED)	AUXILIARY DEFROST FANS (RED)
LG 16 YEL	COACH BATTERY DISCONNECT RELAY (TERMINAL I)	COACH BATTERY DISCONNECT RELAY SWITCH
LH 16 YEL	COACH BATTERY DISCONNECT RELAY (TERMINAL S)	COACH BATTERY DISCONNECT RELAY SWITCH
LJ 16 YEL	COACH BATTERY DISCONNECT RELAY BATTERY SIDE FUSE FEED	COACH BATTERY DISCONNECT RELAY SWITCH
LK 16 YEL	COACH BATTERY DISCONNECT RELAY LOAD SIDE FUSE FEED	COACH BATTERY DISCONNECT RELAY SWITCH/INDICATOR LAMP
LL 16 WHT	GENERATOR SWITCH (START)	GENERATOR (RED)
LM 16 WHT	GENERATOR SWITCH (STOP)	GENERATOR (ORN)
LN 16 WHT	GENERATOR SWITCH/INDICATOR (GROUND)	GENERATOR (GRN)
LP 16 YEL	GENERATOR SWITCH/INDICATOR (RUN)	GENERATOR (BLU)
LR 14 YEL	BATTERY MODE SWITCH (AUX START SWITCH)	BATTERY MODE SOLENOID (AUX START SOLENOID)
LS 12 YEL	OVERCURRENT PROTECTION 20A BREAKER TYPICAL,COACH FEED	GENERAL PURPOSE(BATTERY MODE, RADIO POWER,BATTERY CONDITION)
LT 16 YEL	BATTERY CONDITION SWITCH	VOLTMETER (POWER FEED)

CODE/COLOR	FROM:	WIRE IDENTIFICATION CHART TO:
LU 14 YEL	CHASSIS BRAKE LAMP CIRCUIT	VEHICLE BRAKES, TAG AXLE CONTROL MODULE,ETC.
LW 14 YEL	WIPER CONTROL MODULE (PARK)	WINDSHIELD WIPER MOTOR (FRONT)
LX 14 YEL	WIPER CONTROL MODULE (LOW SPEED)	WINDSHIELD WIPER MOTOR (FRONT)
LY 14 YEL	WIPER CONTROL MODULE (HIGH SPEED)	WINDSHIELD WIPER MOTOR (FRONT)
MA 14 YEL	WIPER CONTROL MODULE (WASHER BOTTLE PUMP)	WINDSHIELD WASHER BOTTLE PUMP (FRONT)
MB 14 YEL	CHASSIS WINDSHIELD WIPER FEED CIRCUIT	OVERCURRENT PROTECTION (6A BREAKER TYPICAL)
MC 16 WHT	INSTRUMENT PANEL LAMPS	GROUND
MD 14 YEL	OVERCURRENT PROTECTION (15A BREAKER TYPICAL)	REMOTE MIRROR RELAY/POWER WINDOW FEED
ME 14 YEL	OVERCURRENT PROTECTION (15A BREAKER TYPICAL)	AIR HORN RELAY FEED/MARKER LAMPS RELAY FEED
MF 14 YEL	OVERCURRENT PROTECTION (15A BREAKER TYPICAL)	FOG LAMP RELAY FEED/SPOT LAMP FEED
MG 14 WHT	GENERAL PURPOSE(RELAYS,DASH DEVICES,ETC.)	GROUND
MH 16 WHT	CHASSIS CHOKE LAMP INDICATOR CIRCUIT	CHOKE LAMP
MJ 14 YEL	CHASSIS WINDSHIELD WIPER FEED CIRCUIT	WIPER CONTROL MODULE (POWER FEED)
MK 14 YEL	CHASSIS BATTERY POWER FEED CIRCUIT	GENERAL PURPOSE(CIGAR LIGHTER, DOME/COURTESY LAMPS,ETC)
ML 16 YEL	CHASSIS INSTRUMENT PANEL LAMPS FEED CIRCUIT	INSTRUMENT PANEL LAMPS
MM 14 YEL	CHASSIS CLEARANCE LAMP CRT #1 (BRN TYPICAL)	CLEARANCE/MARKER LAMPS
MN 14 WHT	DOME LAMP SWITCHED GROUND	DOME LAMP SWITCH(DOOR JAMB, INSTRUMENT PANEL SWITCH,ETC)
MP 18/16 WHT	ELEC STEP DOOR JAMB SWITCH, LP TANK SENDER, ETC	GROUND
MR 14 YEL	REAR WINDOW WIPER SWITCH (LOW SPEED)	REAR WINDOW WIPER MOTOR (LOW SPEED)

CODE/COLOR	FROM:	WIRE IDENTIFICATION	CHART TO:
MS 14 WHT	CLEARANCE/MARKER LAMPS		GROUND
MT 8 WHT	ELECTRIC STEP		GROUND
MU 14 WHT	GENERAL PURPOSE(CIGAR LIGHTER, DOME LAMPS,12 V OUTLETS,ETC)		GROUND
MW 16 YEL	VEHICLE CHECK ENGINE LAMP CIRCUIT		CHECK ENGINE LAMP
MX 16 YEL	WINDSHIELD WIPER SWITCH		WIPER RELAY
MY 14 YEL	VEHICLE HEADLAMP FEED CIRCUIT		DIMMER MODULE
NA 14 YEL	VEHICLE HEADLAMP LOW BEAM CIRCUIT		DIMMER MODULE
NB 14 YEL	VEHICLE HEADLAMP HIGH BEAM CIRCUIT		DIMMER MODULE
NC 14 WHT	COACH LIGHTING CIRCUIT #1 (REF JC)		GROUND
ND 14 WHT	COACH LIGHTING CIRCUIT #2 (REF JD)		GROUND
NE 14 WHT	COACH LIGHTING CIRCUIT #3 (REF JE)		GROUND
NF 14 WHT	COACH LIGHTING CIRCUIT #4 (REF JF)		GROUND
NG 16 YEL	FOG LAMPS SWITCH		FOG LAMPS RELAY
NH 14 YEL	FOG LAMPS RELAY		FOG LAMPS
NJ 16 YEL	CHASSIS HORN FEED CIRCUIT		AIR HORN SWITCH
NK 14 YEL	AIR HORN SWITCH		AIR HORN AIR TANK AIR RELEASE VALVE
NL 14 YEL	AR HORN RELAY		AIR HORN AIR COMPRESSOR
NM 14 YEL	OVERCURRENT PROTECTION (15A FUSE TYPICAL)		COACH LIGHTING CIRCUIT #6 (REF PM)
NN 16 YEL	LEFT POWER MIRROR MOTOR (HORIZONTAL CONTROL,YEL)		POWER MIRROR CONTROL SWITCH

CODE/COLOR	FROM:	WIRE IDENTIFICATION	CHART TO:
NR 16 YEL	LEFT POWER MIRROR (VERTICAL CONTROL, WHT)		POWER MIRROR CONTROL SWITCH
NS 14 YEL	POWER MIRROR HEATER SWITCH		POWER MIRRORS (RED)
NT 14 YEL	POWER MIRROR RELAY		POWER MIRROR CONTROL SWITCH
NU 14 YEL	AISLE LAMPS SWITCH #1		AISLE LAMPS SWITCH #2
NW 14 YEL	FRONT COMPARTMENT LAMPS SWITCH		COMPARTMENT LAMPS
NX 14 YEL	INTERSTATE COMMERCE COMMITTEE COURTESY BLINK SWITCH		CLEARANCE LAMPS
NY 14 YEL	AISLE LAMPS SWITCH #1		AISLE LAMPS SWITCH #2
PA 14 WHT	REAR AUTO HEATER		GROUND
PB 14 WHT	REAR WINDOW WIPER MOTOR		GROUND
PC 14 YEL	BEDROOM CEILING LAMP SWITCH		BEDROOM CEILING LAMP
PD 14 YEL	MAKE UP LAMP #1 SWITCH		MAKE UP LAMP #1
PE 14 YEL	BATH CEILING LAMP SWITCH		BATH CEILING LAMP
PF 14 YEL	SHOWER LAMP SWITCH WIRE D WAS FIRST USED ON C'S		SHOWER LAMP
PG 14 YEL	WARDROBE LAMP SWITCH		WARDROBE LAMP
PH 14 YEL	AISLE LAMPS SWITCH		AISLE LAMPS
PJ 14 YEL	PORCH LAMP SWITCH		PORCH LAMP
PK 14 YEL	STRIP LAMP SWITCH		STRIP LAMP
PL 14 YEL	FRONT CEILING LAMP SWITCH		FRONT CEILING LAMP
PM 14 WHT	COACH LIGHTING CIRCUIT #6 (REF NM)		GROUND

CODE/COLOR	FROM:	WIRE IDENTIFICATION	CHART TO:
PN 16 WHT	RIGHT POWER MIRROR (COMMON,BLK)		POWER MIRROR CONTROL SWITCH
PP 16 YEL	RIGHT POWER MIRROR (HORIZONTAL CONTROL,YEL)		POWER MIRROR CONTROL SWITCH
PR 16 YEL	RIGHT POWER MIRROR (VERTICAL CONTROL,WHT)		POWER MIRROR CONTROL SWITCH
PS 14 YEL	MAP LAMP SWITCH	MAP LAMP	
PT 14 YEL	BEVERAGE TRAY LAMP SWITCH	BEVERAGE TRAY LAMP	
PU 14 YEL	DUMP LAMP SWITCH	DUMP LAMP	
PW 14 YEL	OVERCURRENT PROTECTION (15A BREAKER TYPICAL)	POWER DOOR LOCK/UNLOCK RELAY (PIN 30)	
PX 16 YEL	POWER DOOR LOCK SWITCH (LOCK) (PIN 1)	POWER DOOR LOCK RELAY (PIN 86)	
PY 16 YEL	POWER DOOR LOCK SWITCH (UNLOCK) (PIN 5)	POWER DOOR UNLOCK RELAY (PIN 86)	
RA 14 YEL	VEHICLE LEFT FRONT TURN SIGNAL CIRCUIT	LEFT FRONT TURN SIGNAL/MARKER LAMP	
RB 14 YEL	VEHICLE RIGHT FRONT TURN SIGNAL CIRCUIT	RIGHT FRONT TURN SIGNAL/MARKER LAMP	
RC 14 WHT	FRONT AUTOMOTIVE LAMPS(TURN, MARKER,ETC)	GROUND	
RD 14 YEL	OVERCURRENT PROTECTION (15 A FUSE TYPICAL)	HAZARD FLASHER, HORN RELAY	
RE 12 YEL	RADIATOR FAN RELAY#1 (COMMON)	RADIATOR FAN #1	
RF 12 YEL	RADIATOR FAN RELAY #2 (COMMON)	RADIATOR FAN #2	
RG 14 WHT	RADIATOR FAN THERMOSTAT SWITCH	RADIATOR FAN RELAYS (COILS,TRIGGER)	
RH 12YEL(BLK)	OVERCURRENT PROTECTION (25A BREAKER TYPICAL)	RADIATOR FAN RELAY #1 (NORMALLY OPEN)	
RJ 12YEL(BLK)	OVERCURRENT PROTECTION (25A BREAKER TYPICAL)	RADIATOR FAN RELAY #2 (NORMALLY OPEN)	
RK 12 WHT	RADIATOR FAN #1	GROUND	

CODE/COLOR	FROM:	WIRE IDENTIFICATION	CHART TO:
RL 12 WHT	RADIATOR FAN #2		GROUND
RM 14 WHT	VEHICLE IGNITION SWITCH GROUND DURING START CIRCUIT		BULB CHECK(LOW TAG AIR,PARK BRAKE,ETC)
RN 14 YEL	AUTOMOTIVE AIR CONDITIONER THERMOSTAT CUTOFF SWITCH		AUTOMOTIVE AIR CONDITIONER COMPRESSOR CLUTCH
RP 14 YEL	AUTOMOTIVE AIR CONDITIONER COOLANT FAN CONTROL		COOLANT FAN RELAY
RR 14 YEL	BRAKE LAMP SWITCH		TURN SIGNAL SWITCH
RS 14 YEL	HEADLAMP SWITCH INSTRUMENT PANEL LAMP FEED SWITCH		OVERCURRENT PROTECTION (5A FUSE TYPICAL)
RT 14 YEL	HORN RELAY (COMMON)		HORN
RU 14 YEL	HORN RELAY (COIL)		HORN SWITCH
RW 14 YEL	HAZARD FLASHER		TURN SIGNAL SWITCH
RX 14 YEL	EUL WARNING LAMP		EUL MODULE
RY 14 WHT	INSTRUMENT CLUSTER/ EUL MODULE		GROUND
SA 14 YEL	ENGINE WATER TEMPERATURE SENDER		ENGINE WATER TEMPERATURE GAUGE
SB 14 YEL	ENGINE OIL PRESSURE SENDER		ENGINE OIL PRESSURE GAUGE
SC 14 YEL	VEHICLE RIGHT REAR TURN SIGNAL/BRAKE LAMP CIRCUIT		RIGHT REAR TURN SIGNAL/ BRAKE LAMPS
SD 14 YEL	VEHICLE LEFT REAR TURN SIGNAL/BRAKE LAMP CIRCUIT		LEFT REAR TURN SIGNAL/ BRAKE LAMPS
SE 16YEL(WHT)	SPEED SENSOR (TWISTED PAIR)		SPEEDOMETER AND SPEED CONTROL MODULE
SF 16WHT(BLK)	SPEED SENSOR (TWISTED PAIR)		SPEEDOMETER AND SPEED CONTROL MODULE
SG 14 YEL	IGNITION SWITCH START FEED		GENERAL(NEUTRAL SAFETY SWITCH, FUEL PUMP RELAY COIL,ETC)
SH 14 YEL	IGNITION SWITCH RUN/START FEED		GENERAL(IGNITION COIL RELAY NORMALLY OPEN CONTACT,ETC)

CODE/COLOR	FROM:	WIRE IDENTIFICATION	CHART TO:
SJ 12YEL(BLK)	OVERCURRENT PROTECTION (16GA FUSELINK TYPICAL)	CHASSIS BATTERY FEED	
SK 12YEL(WHT)	OVERCURRENT PROTECTION (16GA FUSELINK TYPICAL)	CHASSIS BATTERY HEADLAMP SWITCH FEED #1	
SL 12YEL(BLU)	OVERCURRENT PROTECTION (16GA FUSELINK TYPICAL)	CHASSIS BATTERY IGNITION SWITCH FEED #1	
SM 12YEL(BLK)	OVERCURRENT PROTECTION (16GA FUSELINK TYPICAL)	RADIATOR FAN #1 CIRCUIT BREAKER FEED	
SN 12YEL(BLK)	OVERCURRENT PROTECTION (16GA FUSELINK TYPICAL)	RADIATOR FAN #2 CIRCUIT BREAKER FEED	
SP 14 YEL	HEADLAMP SWITCH MARKER CIRCUIT FEED	OVERCURRENT PROTECTION (15A FUSE TYPICAL)	
SR 12YEL(BRN)	IGNITION SWITCH RUN ONLY FEED	OVERCURRENT PROTECTION (15A FUSE TYPICAL)	
SS 12YEL(WHT)	IGNITION SWITCH ACCESSORY FEED	OVERCURRENT PROTECTION (15A FUSE TYPICAL)	
ST 14 YEL	OVERCURRENT PROTECTION (15A FUSE TYPICAL)	TURNS/BACK UP CIRCUIT FEED	
SU	STARTER SOLENOID BATTERY TERMINAL	ALTERNATOR BATTERY TERMINAL	
SW 14 YEL	TURN SIGNAL FLASHER	TURN SIGNAL SWITCH	
SX 14 YEL	REAR WINDOW WASHER SWITCH	REAR WINDOW WASHER BOTTLE PUMP	
SY 14 YEL	IGNITION COIL	TACHOMETER	
TA 14 YEL	OVERCURRENT PROTECTION (15A FUSE TYPICAL)	IGNITION RUN ONLY GENERAL FEED (RADIATOR FAN RELAY COIL,ETC)	
TB 12 YEL	OVERCURRENT PROTECTION (25A FUSE TYPICAL)	IGNITION RUN ONLY GENERAL FEED (AUTO AC BLOWER(NOT HIGH),ETC)	
TC 14 YEL	OVERCURRENT PROTECTION (15A FUSE TYPICAL)	IGNITION RUN ONLY GENERAL FEED (DOOR LOCKS,REAR WIPER,ETC.)	
TD 14 YEL	OVERCURRENT PROTECTION (15A FUSE TYPICAL)	CHASSIS BATTERY GENERAL FEED	
TE 16 WHT	GENERATOR	GENERATOR LOW OIL INDICATOR LAMP	
TF 16 YEL	GENERATOR	GENERATOR LOW OIL INDICATOR LAMP	

CODE/COLOR	FROM:	WIRE IDENTIFICATION	CHART TO:
TG 16 YEL	TELEVISION		SPEAKER RIGHT (POSITIVE)
TH 16 WHT	TELEVISION		SPEAKER RIGHT (NEGATIVE)
TJ 16 YEL	TELEVISION		SPEAKER LEFT (POSITIVE)
TK 16 WHT	TELEVISION		SPEAKER LEFT (NEGATIVE)
TL 16 YEL	FRONT RIGHT TV SPEAKER NEGATIVE,SERIES CONNECTION		FRONT LEFT TV SPEAKER POSITIVE,SERIES CONNECTION
TM 16 WHT	STEP COVER SWITCH		STEP COVER SOLENOID MOVES STEP OUT
TN 14 YEL	STARTER SOLENOID BATTERY TERMINAL		ALTERNATOR REGULATOR
TP 14 WHT	REAR AUTOMOTIVE LAMPS(TURN, MARKER,ETC)		GROUND
TR 14 YEL	VEHICLE BACK UP CIRCUIT FEED		BACK UP LAMPS
TS 14 YEL	STARTER SOLENOID (I TERMINAL)		ENGINE WIRING (IGNITION MODULE)
TT 14 YEL	NEUTRAL SAFETY SWITCH		STARTER SOLENOID (S TERMINAL)
TU 14 WHT	IGNITION COIL RELAY (COIL)		GROUND
TW 14 YEL	IGNITION SWITCH START/RUN FEED		IGNITION COIL
TX 14 YEL	IGNITION COIL RELAY (COMMON)		IGNITION COIL
TY 14 YEL	ALTERNATOR (T TERMINAL)		CHOKE HEATER
UA 14 YEL	FUEL PUMP FUSE		OIL PRESSURE CUTOUT SWITCH/ FUEL PUMP RELAY(NO),ETC
UB 14 YEL	INERTIA SWITCH (FUEL PUMP SHUTOFF)		FUEL PUMP RELAY (NORMALLY CLOSED)
UC 14 YEL	FUEL PUMP RELAY (COMMON)		FUEL PUMP
UD 16 WHT	FUEL GAUGE		FUEL SENDER

CODE/COLOR	FROM:	WIRE IDENTIFICATION	CHART TO:
UE 14 YEL	INERTIA SWITCH (FUEL PUMP SHUTOFF)		OIL PRESSURE CUTOFF SWITCH
UF 14 WHT	FUEL PUMP		GROUND
UG 14 WHT	FUEL PUMP RELAY (COIL)		GROUND
UH 16 YEL	LP DETECTOR (SHUTOFF SYSTEM,YEL)		LP SAFETY VALVE
UJ 16 YEL	LP DETECTOR (SHUTOFF SYSTEM,YEL)		LP SAFETY SWITCH
UK 16 WHT	LP DETECTOR (BLK)(REF WB)		GROUND
UL 16 WHT	EUL LAMP		EUL MODULE
UM 16 WHT	DOOR JAMB DOME LAMP SWITCH		GROUND
UN 16 WHT	SEAT BELT LAMP		EUL MODULE
UP 16 YEL	SEAT BELT LAMP		SEAT BELT BUZZER
UR 16 WHT	PARK BRAKE SWITCH		PARK BRAKE LAMP
US 16 YEL	OVERCURRENT PROTECTION (6A BREAKER TYPICAL)		COACH BATTERY FEED TO BATTERY CONDITION SWITCH
UT 14 YEL	DOOR JAMB DOME LAMP SWITCH (SWITCH POSITIVE)		DOME LAMP
UU 16 YEL	WATER HEATER		VACUUM VALVE SOLENOID
UW 16 WHT	VACUUM VALVE SOLENOID		GROUND
UX 16 YEL	LP DETECTOR #2 (SHUTOFF SYSTEM,YEL)		LP SAFETY VALVE
UY 16 YEL	LP DETECTOR #2 (SHUTOFF SYSTEM,YEL)		LP SAFETY VALVE
WA 14 YEL	EXTERIOR SERVICE LAMP SWITCH		EXTERIOR SERVICE LAMP
WB 16 YEL	OVERCURRENT PROTECTION (6A BREAKER TYPICAL)		LP DETECTOR (REF UK)

CODE/COLOR	FROM:	WIRE IDENTIFICATION	CHART TO:
WC 14 YEL	OVERCURRENT PROTECTION (15A BREAKER TYPICAL)		COMPARTMENT LAMPS (REF WE)
WD 14 WHT	AISLE LAMPS		GROUND
WE 14 WHT	COMPARTMENT LAMPS (REF WC)		GROUND
WF 12YEL(WHT)	OVERCURRENT PROTECTION (30A BREAKER TYPICAL)		PARK BRAKE COMPRESSOR SOENOID
WG 12YEL(BLK)	OVERCURRENT PROTECTION (30A BREAKER TYPICAL)		IGNITION RELAY
WH 14 YEL	OVERCURRENT PROTECTION (15A BREAKER TYPICAL)		IGNITION SWITCH RUN ONLY FEED
WJ 12 YEL	OVERCURRENT PROTECTION (20A BREAKER TYPICAL)		IGNITION SWITCH ACCESSORY FEED RELAY
WK 14 YEL	OVERCURRENT PROTECTION (15A BREAKER TYPICAL)		IGNITION SWITCH ACCESSORY FEED
WL 14 YEL	POWER DOOR LOCK RELAY (PIN 30)		POWER DOOR LOCK MOTOR(S) (LOCK)
WM 14 WHT	POWER DOOR UNLOCK RELAY (PIN 30)		POWER DOOR LOCK MOTOR(S) (UNLOCK)
WN 16 YEL	RADIO POWER SWITCH (ACCESSORY POWER)		DASH RADIO (ACCESSORY POWER)
WP 10 YEL	OVERCURRENT PROTECTION (25A BREAKER TYPICAL)		FRONT PANEL LOADS(INVERTER, RADIO)(96 M-SERIES)
WR 14 YEL	OVERCURRENT PROTENTION (15A BREAKER TYPICAL)		POWER SEAT LIFT SWITCH
WS 14 WHT	POWER SEAT LIFT SWITCH		GROUND
WT 14 YEL	POWER SEAT LIFT SWITCH (UP)		MOTOR (POSITIVE UP)
WU 14 WHT	POWER SEAT LIFT SWITCH (DOWN)		MOTOR (POSITIVE DOWN)
WW 14 WHT	SPOT LAMP SWITCH		GROUND
WX 14 YEL	HALLWAY CEILING LAMP SWITCH		HALLWAY CEILING LAMP
WY 10 WHT	AUTOMOTIVE AIR CONDITIONER MOTOR		GROUND

CODE/COLOR	FROM:	WIRE IDENTIFICATION CHART TO:
XA 12/10 YEL	VEHICLE AUTOMOTIVE AIR FEED CIRCUIT	AUTOMOTIVE AIR CONDITIONER BLOWER (USE 10 IF OVER 6')
XB 14 YEL	DRIVER'S DOOR POWER WINDOW SWITCH(PIN 5)	DRIVER'S DOOR POWER WINDOW MOTOR(POSITIVE UP)
XC 14 WHT	DRIVER'S DOOR POWER WINDOW SWITCH(PIN 1)	DRIVER'S DOOR POWER WINDOW MOTOR(POSITIVE DOWN)
XD 16 WHT	MONITOR PANEL	HOLDING TANK LEVEL SENSOR (FULL)
XE 16 WHT	MONITOR PANEL	HOLDING TANK LEVEL SENSOR (3/4)
XF 16 WHT	MONITOR PANEL	HOLDING TANK LEVEL SENSOR (1/2)
XG 16 WHT	MONITOR PANEL	HOLDING TANK LEVEL SENSOR (1/4)
XH 16 YEL	MONITOR PANEL	WATER TANK LEVEL SENSOR
XJ 16 YEL	MONITOR PANEL	BLACK HOLDING LEVEL SENSOR (MAIN TANK)
XK 16 YEL	MONITOR PANEL	GRAY AUXILIARY HOLDING TANK #1 LEVEL SENSOR (AUX TANK #1)
XL 16 YEL	MONITOR PANEL	GRAY AUXILIARY HOLDING TANK #2 LEVEL SENSOR (AUX TANK #2)
XM 14 YEL	OVERCURRENT PROTECTION (18GA FUSELINK TYPICAL)	IGNITION START RELAY
XN 16 YEL	FRONT ROOF AIR CONDITIONER (EXHAUST)	THERMOSTAT (EX TERMINAL)
XP 16 YEL	FRONT ROOF AIR CONDITIONER (COOL)	THERMOSTAT (Y TERMINAL)(Y EXPORT AIR)
XR 16 YEL	FRONT ROOF AIR CONDITIONER (HIGH SPEED BLOWER)	THERMOSTAT (GH TERMINAL)(H EXPORT AIR)
XS 16 YEL	FRONT ROOF AIR CONDITIONER (LOW SPEED BLOWER)	THERMOSTAT (GL TERMINAL)(G EXPORT AIR)
XT 14 YEL	IGNITION START RELAY #1 (NORMALLY CLOSED CONTACT)	IGNITION START RELAY #2 (COMMON CONTACT)
XU 14 YEL	DINETTE OVHD LAMP SWITCH	DINETTE OVHD LAMP
XW 14 WHT	IGNITION SWITCH ACCESSORY FEED RELAY CIRCUIT	GROUND

CODE/COLOR	FROM:	WIRE IDENTIFICATION CHART TO:
XX 14 YEL	GALLEY LAMP SWITCH	GALLEY LAMP
XY 14 YEL	MAKE UP LAMP #2 SWITCH	MAKE UP LAMP #2
YA 14 YEL	TAG AXLE PRESSURE CONTROL SWITCH	COMPRESSOR SOLENOID/ SOLENOID AIR VALVE
YB 14 WHT	LOW AIR PRESSURE SWITCH	GROUND
YC 10YEL(BLU)	OVERCURRENT PROTECTION (30A BREAKER TYPICAL)	TAG AXLE COMPRESSOR SOLENOID
YD 14 WHT	TAG AXLE MOUNTING PLATE SCREW	GROUND
YE 10 WHT	TAG AXLE COMPRESSOR	GROUND
YF 12 WHT	TAG AXLE BRAKE CONTROL MODULE/BRAKE MAGNET	GROUND
YG 12YEL(BLK)	OVERCURRENT PROTECTION (20A BREAKER TYPICAL)	TAG AXLE BRAKE CONTROL MODULE
YH 12YEL(BLU)	TAG AXLE BRAKE CONTROL MODULE	TAG AXLE BRAKE MAGNET
YJ 10YEL(WHT)	TAG AXLE COMPRESSOR SOLENOID	TAG AXLE COMPRESSOR
YK 14 YEL	BEDROOM CEILING LAMP SWITCH#1 (2 SWITCH SYSTEM)	BEDROOM CEILING LAMP SWITCH #2 (2 SWITCH SYSTEM)
YL 14 YEL	BEDROOM CEILING LAMP SWITCH #1 (2 SWITCH SYSTEM)	BEDROOM CEILING LAMP SWITCH #2 (2 SWITCH SYSTEM)
YM 14 YEL	HALLWAY CEILING LAMP SWITCH #1 (2 SWITCH SYSTEM)	HALLWAY CEILING LAMP SWITCH #2 (2 SWITCH SYSTEM)
YN 14 YEL	HALLWAY CEILING LAMP SWITCH #1 (2 SWITCH SYSTEM)	HALLWAY CEILING LAMP SWITCH #2 (2 SWITCH SYSTEM)
YP 14 YEL	VALANCE LAMP SWITCH #1 (3 WAY SWITCH)	VALANCE LAMP SWITCH #2 (3 WAY SWITCH)
YR 14 YEL	VALANCE LAMP SWITCH #1 (3 WAY SWITCH)	VALANCE LAMP SWITCH #2 (3 WAY SWITCH)
YS 14 YEL	VALANCE LAMP SWITCH	VALANCE LAMP
YT 14 YEL	FRONT VALANCE LAMP SWITCH	FRONT VALANCE LAMP

CODE/COLOR	FROM:	WIRE IDENTIFICATION CHART TO:
YU 14 YEL	REAR VALANCE LAMP SWITCH	REAR VALANCE LAMP
YW 14 WHT	DOOR BELL SWITCH	DOOR BELL
YX 14 YEL	IGNITION SWITCH RUN/START FEED	ALTERNATOR WARNING LAMP
YY 14 YEL	ALTERNATOR VOLTAGE REGULATOR	ALTERNATOR WARNING LAMP
AAA 16 WHT	STEP COVER SWITCH (REF GX)	STEP COVER SOLENOID MOVES STEP IN
AAB 14 YEL	DINETTE READING LAMPS	DINETTE READING LAMP SWITCH
AAC 14 YEL	LOUNGE READING LAMPS	LOUNGE READING LAMP SWITCH
AAD 14 YEL	FORD CHASSIS TRAILER MARKER LAMP CIRCUIT (BR/WHT)	TRAILER CONNECTOR SOCKET MARKER LAMPS
AAE 14 YEL	FORD CHASSIS TRAILER BACKUP LAMP CIRCUIT (BLK/LT GRN)	TRAILER CONNECTOR SOCKET BACKUP LAMPS
AAF 14 YEL	FORD CHASSIS TRAILER LEFT TURN/BRAKE LAMP CIRCUIT (YEL)	TRAILER CONNECTOR SOCKET LEFT TURN/BRAKE LAMP
AAG 14 YEL	FORD CHASSIS TRAILER RIGHT TURN/BRAKE LAMP CIRCUIT (DKG)	TRAILER CONNECTOR SOCKET RIGHT TURN/BRAKE LAMP
AAH 14 YEL	BATH-VENT,POWER	BATH-VENT, THERMOSTAT
AAJ 14 YEL	BATH-VENT,POWER	BATH-VENT, THERMOSTAT
AAK 16 WHT	SWITCH-WATER PUMP (MULTIPLEX SYSTEM)	LATCHING RELAY (WITH 4 OR MORE SWITCHES)
AAL 16 WHT	SWITCH-WATER PUMP (MULTIPLEX SYSTEM)	GROUND
AAM 14 YEL	CHASSIS SUPPLIED WIRE ASM (DARK BLUE)(GM)	RIGHT TAIL LAMP PARK (WIE)
AAN 14 YEL	CHASSIS SUPPLIED WIRE ASM (PURPLE)(GM)	LEFT TAIL LAMP PARK (WIE)
AAP 10 YEL	55 AMP BREAKER JUMPER WIRE	30 AMP BREAKER
AAR 14 YEL	TV/RADIO SPEAKER FEED SELECTOR SWITCH	TV SPEAKER AMPLIFIER

CODE/COLOR	FROM:	WIRE IDENTIFICATION CHART TO:
AAS 16 YEL	TV SPEAKER (NEGATIVE) BEDROOM SPEAKERS IN SERIES	TV SPEAKER (POSITIVE)
AAT 16 YEL	AMPLIFIER POSITIVE OUT (AAU NEGATIVE)	FRONT WOOFER (WITH DELUXE SOUND SYSTEM)
AAU 16 WHT	AMPLIFIER NEGATIVE OUT (AAT POSITIVE)	FRONT WOOFER (WITH DELUXE SOUND SYSTEM)
AAW 16 YEL	AMPLIFIER POSITIVE OUT (AAX NEGATIVE)	REAR WOOFER (WITH DELUXE SOUND SYSTEM)
AAX 16 WHT	AMPLIFIER NEGATIVE OUT (AAW POSITIVE)	REAR WOOFER (WITH DELUXE SOUND SYSTEM)
AAZ 12 YEL	SLIDEOUT ROOM CONTROL SWITCH (RAM #1)	SLIDEOUT DRIVE MOTOR LEAD #1
AAZ 12 YEL	SLIDEOUT ROOM CONTROL SWITCH (RAM #1)	SLIDEOUT DRIVE MOTOR LEAD #2
BBA 16 WHT	SLIDEOUT WIRING (PARK BRAKE SW)(SWITCHED GRD)	SLIDEOUT ROOM RELAY (GROUND TERMINAL)
BBB 16 YEL	SLIDEOUT ROOM CIRCUIT BREAKER (6 AMP)	SLIDEOUT ROOM RELAY (PIN 86 & 87)
BBC 16 YEL	LOAD SHEDDER MONITOR PANEL (RED WIRE)	LOAD SHEDDER CONTROL BOARD (RED WIRE)
BBD 16 YEL	LOAD SHEDDER MONITOR PANEL (BLUE WIRE)	LOAD SHEDDER CONTROL BOARD (BLUE WIRE)
BBE 16 YEL	LOAD SHEDDER MONITOR PANEL (BLACK WIRE)	LOAD SHEDDER CONTROL BOARD (BLACK WIRE)
BBF 16 YEL	LOAD SHEDDER MONITOR PANEL (GRAY WIRE)	LOAD SHEDDER CONTROL BOARD (GRAY WIRE)
BBG 14 YEL	DINETTE CEILING LAMP SWITCH	DINETTE CEILING LAMP
BBH 16 YEL	REAR COMPRESSOR SIGNAL REAR THERMOSTAT	LOAD SHEDDER CONTROL BOARD
BBJ 16 YEL	LOAD SHEDDER CONTROL BOARD	REAR A/C (COOL)
BBK 12 WHT	JET AIR/TAG AXLE WIRING	GROUND, CHASSIS
BBL 14 YEL	OVHD SWITCH	OVHD HALOGEN LAMPS
BBM 16 YEL	SLIDEOUT ROOM SWITCH (ROOM TWO EXTEND)	HWH WIRING (ROOM TWO EXTEND)

CODE/COLOR	FROM:	WIRE IDENTIFICATION CHART TO:
BBN 16 YEL	SLIDEOUT ROOM SWITCH (ROOM TWO RETRACT)	HWH WIRING (ROOM TWO RETRACT)
BBP 14 YEL	ICC COURTESY BLINK SWITCH	ICC COURTESY BLINK RELAY
BBR 14 YEL	ICC COURTESY BLINK RELAY	CLEARANCE LAMPS
BBS 14 YEL	CHASSIS FUSE PANEL	ICC COURTESY BLINK RELAY
BBT 14 YEL	DOCKING LAMP SWITCH TRIGGER RELAY	DOCKING LAMP SWITCH
BBU 12 YEL	DOCKING LAMP CIRCUIT BREAKER	DOCKING LAMP RELAY
BBW 14 YEL	FORD LEFT HAND LOW BEAM CIRCUIT	LEFT HAND LOW BEAM
BBX 14 YEL	FORD RIGHT HAND LOW BEAM CIRCUIT	RIGHT HAND LOW BEAM
BBY 14 YEL	SWITCH-MONITOR PANEL (IN EXT. WATER CENTER)	EXTERIOR MONITOR PANEL (IN EXT. WATER CENTER)
BBZ 14 YEL	OVERCURRENT PROTECTION (15A FUSE/BREAKER TYPICAL)	AUXILIARY FURNACE (CCA)
CCA 14 WHT	AUXILIARY FURNACE	GROUND
CCB 16 YEL	EXTERIOR MONITOR PANEL	WATER TANK LEVEL SENSOR
CCC 16 YEL	EXTERIOR MONITOR PANEL	MAIN HOLDING TANK LEVEL SENSOR
CCD 16 YEL	EXTERIOR MONITOR PANEL	AUX HOLDING TANK LEVEL SENSOR
CCE 14 YEL	COMPARTMENT LAMP SWITCH	COMPARTMENT LAMP
CCF 14 YEL	COMPARTMENT LAMP SWITCH	COMPARTMENT LAMP
CCG 14 YEL	COMPARTMENT LAMP SWITCH	COMPARTMENT LAMP
CCH 14 YEL	COMPARTMENT LAMP SWITCH	COMPARTMENT LAMP
CCJ 14 YEL	COMPARTMENT LAMP SWITCH	COMPARTMENT LAMP

CODE/COLOR	FROM:	WIRE IDENTIFICATION CHART TO:
CCK 14 YEL	COMPARTMENT LAMP SWITCH	COMPARTMENT LAMP
CCL 14 YEL	COMPARTMENT LAMP SWITCH	COMPARTMENT LAMP
CCM 14 YEL	COMPARTMENT LAMP SWITCH	COMPARTMENT LAMP
CCN 16 YEL	THERMOSTATE LOW SPEED FAN SIGNAL	CENTRAL AIR AND LOAD SHEDDER
CCP 16 YEL	LOAD SHEDDER COMPRESSOR TWO CONTROL RELAY	CENTRAL A/C COMPRESSOR TWO
CCR 14 YEL	SWITCH-MONITOR PANEL (IN EXT. WATER CENTER)	EXTERIOR MONITOR PANEL (IN EXT. WATER CENTER)
CCS 16 YEL	NOISE FILTER	RADIO POWER INPUT
CCT 16 YEL	REAR RIGHT TV SPEAKER NEGATIVE,SERIES CONNECTION	REAR LEFT TV SPEAKER POSITIVE,SERIES CONNECTION
CCU 16 YEL	GM DOME LAMP POWER	DOME LAMP
CCW 12 YEL	DUAL MODE SOLENOID (CHASSIS SIDE)	FUSE HOLDER (30 AMP)
C CX 16 YEL	ORG WIRE ON AIR COMPRESSOR	AIR PRESSURE SWITCH ON AIR TANK
CCY 16 YEL	HWH WIRING (BATTERY POWER)	SLIDEOUT ROOM SWITCH (POSITIVE)
CCZ 16 YEL	HWH WIRING (SWITCHED BATTERY POWER)	SLIDEOUT ROOM #1 SWITCH (POSITIVE)
DDA 16 YEL	HWH WIRING (PUMP RELAY CONTROL)	SLIDEOUT ROOM SWITCH (POSITIVE)
DDB 14 YEL	REAR AUTO HEATER CIRCUIT BREAKER	REAR AUTO HEATER RELAY (POWER)
DDC 14 YEL	REAR AUTO HEATER RELAY (SWITCHED POWER)	REAR AUTO HEATER SWITCH (COMMON TERMINAL)
DDD 14 YEL	MODULE-CHARGE CONTROL RELAY OUTPUT	AUX-START SOLENOID RELAY
DDE 14 YEL	AUX-START SOLENOID RELAY	AUX-START SOLENOID
DDF 10 YEL	HEATER BLOWER CIRCUIT BREAKER	HEATER BLOWER RELAY

CODE/COLOR	FROM:	WIRE IDENTIFICATION	CHART TO:
DDG 10 YEL	CIRCUIT BREAKER BUSS BAR		CHASSIS BATTERY FEED CIRCUIT BREAKER
DDH 14 YEL	FREIGHTLINER RUN ONLY TRIGGER CIRCUIT		HEATER BLOWER RELAY
DDJ 14 YEL	FREIGHTLINER PARKING BRAKE TRIGGER CIRCUIT		HWH WIRE ASM-PARKING BRAKE SENSOR WIRE
DDK 16 YEL	HWH WIRING (PUMP RELAY CONTROL)		REAR SLIDEBOUT ROOM SWITCH (POSITIVE)
DDL 14 WHT	FRONT LEFT AUTOMOTIVE LAMPS		GROUND
DDM 14 WHT	FRONT RIGHT AUTOMOTIVE LAMPS		GROUND
DDN 16 YEL	TIMER MODULE		CHECK ANTENNA LIGHT
DDP 12 YEL	OVERCURRENT PROTECTION (20A BREAKER TYPICAL)		INVERTER FEED (INVERTER NUMBER 2)
DDR 12 WHT	INVERTER (INVERTER NUMBER 2)		GROUND
DDS 12 WHT	INVERTER CHASSIS (INVERTER NUMBER 2)		GROUND
DDT 12 YEL	POWER COMPT DOOR LOCK RELAY (RIGHT SIDE)		POWER COMPT DOOR LOCK MOTOR(S) (RIGHT SIDE)
DDU 12 WHT	POWER COMPT DOOR UNLOCK RELAY (RIGHT SIDE)		POWER COMPT LOCK MOTOR(S) (UNLOCK) (RIGHT SIDE)
DDV 12 YEL	POWER COMPT DOOR LOCK RELAY (LEFT SIDE)		POWER COMPT LOCK MOTOR(S) (LOCK) (LEFT SIDE)
DDW 12 WHT	POWER COMPT DOOR UNLOCK RELAY (LEFT SIDE)		POWER COMPT LOCK MOTOR(S) (UNLOCK) (LEFT SIDE)
DDX 12 YEL	OVERCURRENT PROTECTION (20A BREAKER TYPICAL)		POWER COMPT DOOR LOCK/ UNLOCK RELAY (RIGHT SIDE)
DDY 12 YEL	OVERCURRENT PROTECTION (20A BREAKER TYPICAL)		POWER COMPT DOOR LOCK/ UNLOCK RELAY (LEFT SIDE)
DDZ 12 YEL	POWER COMPT DOOR LOCK SWITCH (LOCK) (PIN 1)		POWER COMPT DOOR LOCK RELAY (PIN 86)
EEA 12 WHT	POWER COMPT DOOR LOCK SWITCH (UNLOCK) (PIN 5)		POWER COMPT DOOR UNLOCK RELAY (PIN 86)
EEB 12 WHT	POWER COMPT DOOR LOCK RELAYS (LEFT SIDE)		GROUND

CODE/COLOR	FROM:	WIRE IDENTIFICATION	CHART TO:
EEC 12 YEL	25 AMP BREAKER IN 12 VOLT PANEL		SOFA RECLINER SWITCH SOFA 4-WAY RECLINER
EED 12 WHT	SOFA RECLINER SWITCH SOFA 4-WAY RECLINER		GROUND
EEE 14 YEL	OVERCURRENT PROTECTION (15A BREAKER TYPICAL)		12V POWER JACK
EEF 14 WHT	12V POWER JACK		GROUND
EEG 12 WHT	POWER COMPT DOOR LOCK RELAYS (RIGHT SIDE)		GROUND
EEH 12 YEL	SOFA RECLINER SWITCH EXTEND		SOFA RECLINER MOTOR SOFA 4-WAY
EEJ 12 YEL	SOFA RECLINER SWITCH RETRACT		SOFA RECLINER MOTOR SOFA 4-WAY
EEK 16 YEL	AUDIO AMPLIFIER		LH FRT SPKR (+)
EEL 16 WHT	AUDIO AMPLIFIER		LH FRT SPKR (-)
EEM 16 YEL	AUDIO AMPLIFIER		RH FRT SPKR (+)
EEN 16 WHT	AUDIO AMPLIFIER		RH FRT SPKR (-)
EEP 16 YEL	AUDIO AMPLIFIER		LH RR SPKR (+)
EER 16 WHT	AUDIO AMPLIFIER		LH RR SPKR (-)
EES 16 YEL	AUDIO AMPLIFIER		RH RR SPKR (+)
EET 16 WHT	AUDIO AMPLIFIER		RH RR SPKR (-)
EEU 16 YEL	AUDIO AMPLIFIER		CTR CHANNEL SPKR (+)
EEW 16 WHT	AUDIO AMPLIFIER		CTR CHANNEL SPKR (-)
EEY 12/10 YEL	PASSENGER AUTO A/C FEED CIRCUIT		PASSENGER AUTO A/C BLOWER (USE 10 IF OVER 6')
EEZ 10 WHT	PASSENGER AUTO A/C MOTOR		GROUND

CODE/COLOR	FROM:	WIRE IDENTIFICATION CHART TO:
EEZ 12/10 YEL	OVERCURRENT PROTECTION (30A BREAKER TYPICAL)	PASSENGER HI-SPEED HEATER FAN (USER 10 IF OVER 6')
FFA 10 YEL	PASSENGER HEATER BLOWER CIRCUIT BREAKER	PASSENGER HEATER BLOWER RELAY
FFB 10 YEL	OVERCURRENT PORTECTION (30A BREAKER TYPICAL)	POWER LOUNGE CHAIR
FFC 10 WHT	POWER LOUNGE CHAIR	GROUND
FFD 12 YEL	OVERCURRENT PROTECTION (30A BREAKER TYPICAL)	AWNING CONTROL BOX (12V POSITIVE)
FFE 12 WHT	AWNING CONTROL BOX	GROUND
FFF 12 YEL	AWNING CONTROL BOX	DOOR AWNING (MOTOR POSITIVE)
FFG 12 WHT	DOOR AWNING (MOTOR GROUND)	AWNING CONTROL BOX
FFH 12 YEL	AWNING CONTROL BOX	PATIO AWNING (MOTOR POSITIVE)
FFJ 12 WHT	PATIO AWNING (MOTOR GROUND)	AWNING CONTROL BOX
FFK 16 YEL	AWNING CONTROL BOX	DOOR AWNING SWITCH (EXTEND)
FFL 16 YEL	DOOR AWNING SWITCH (COMMON)	AWNING CONTROL BOX
FFM 16 YEL	AWNING CONTROL BOX	DOOR AWNING SWITCH (RETRACT)
FFN 16 YEL	AWNING CONTROL BOX	PATIO AWNING SWITCH (EXTEND)
FFP 16 YEL	PATIO AWNING SWITCH (COMMON)	AWNING CONTROL BOX
FFR 16 YEL	AWNING CONTROL BOX	PATIO AWNING SWITCH (RETRACT)
FFS 14 WHT	RELAY (PIN 30)	AWNING CONTROL BOX
FFT 14 WHT	PATIO AWNING SWITCH	AWNING CONTROL BOX
FFU 16 YEL	AWNING SELECTOR SWITCH (DOOR AWNING)	AWNING CONTROL SWITCH (DOOR AWNING)

CODE/COLOR	FROM:	WIRE IDENTIFICATION CHART TO:
FFV 16 YEL	AWNING SELECTOR SWITCH (PATIO AWNING)	AWNING CONTROL SWITCH (PATIO AWNING)
FFW 14 YEL	LOUNGE LAMPS SWITCH #1	LOUNGE LAMPS SWITCH #2
FFX 14 YEL	LOUNGE LAMPS SWITCH #1	LOUNGE LAMPS SWITCH #2
FFY 14 YEL	CEILING FAN SWITCH	CEILING FAN
FFZ 14 YEL	OVERCURRENT PROTECTION (15A FUSE/BREAKER TYPICAL)	COACH LIGHTING,ETC CIRCUIT #7 (REF GGA)
GGA 14 WHT	COACH LIGHTING (REF-FFZ)	GROUND
GGB 14 YEL	POWER LIFT VENT	POWER LIFT SWITCH (UP)
GGC 14 YEL	POWER LIFT VENT	POWER LIFT SWITCH (DOWN)
GGD 16 YEL	CONTROL MODULE	OPERATOR PANEL (STOP)
GGE 16 YEL	CONTROL MODULE	OPERATOR PANEL (GRN LED)
GGF 16 YEL	CONTROL MODULE	OPERATOR PANEL (RED LED)
16 YEL		(SIGNAL)
16 YEL		(+)
16 WHT		(-)
16 YEL		(SIGNAL)
16 YEL		(+)
16 WHT		(-)
GGN 12 YEL	CONTROL MODULE (RAM #2)	SLIDEOUT ACTUATOR DRIVE LEAD #1
GGP 12 YEL	CONTROL MODULE (RAM #2)	SLIDEOUT ACTUATOR DRIVE LEAD #2
GGR 16 YEL	FRONT ROOF HEAT PUMP	THERMOSTAT (W TERMINAL)
GGS 16 YEL	REAR ROOF HEAT PUMP	THERMOSTAT (W TERMINAL)

CODE/COLOR	FROM:	WIRE IDENTIFICATION	CHART TO:
GGT 12 YEL	SOFA RECLINER SWITCH EXTEND	SOFA RECLINER MOTOR SOFA 4-WAY	
GGU 12 YEL	SOFA RECLINER SWITCH RETRACT	SOFA RECLINER MOTOR SOFA 4-WAY	
GGV 14 WHT	GPS (BLACK WIRE)	GROUND	
GGW 16 YEL	GPS (GREEN/WHITE WIRE)	VEHICLE SPEED SENSOR (CHASSIS SUPPLIED)	
GGX 14 YEL	10 OHM RESISTOR *	BEDROOM CEILING FAN (LOW SPEED)	
GGY 14 YEL	BATHROOM VENT SWITCH	BATHROOM VENT	
GGZ 14 YEL	BEDROOM VENT SWITCH	BEDROOM VENT	
HHA 14 YEL	OVERCURRENT PROTECTION (15A FUSE/BREAKER TYPICAL)	COACH VENTS/LAMPS (REF HHB)	
HHB 14 WHT	COACH VENTS/LAMPS (REF HHA)	GROUND	
HHC 12 YEL	STEP COVER SWITCH	STEP COVER MOTOR (+)RETRACT, (-)EXTEND	
HHD 12 YEL	STEP COVER SWITCH	STEP COVER MOTOR (-)EXTEND, (+)RETRACT	
HHE 16 YEL	SLIDEOUT ROOM SWITCH (ROOM THREE EXTEND)	HWH WIRING (ROOM THREE EXTEND)	
HHF 16 YEL	SLIDEOUT ROOM SWITCH (ROOM THREE RETRACT)	HWH WIRING (ROOM THREE RETRACT)	
HHG 16 YEL	SLIDEOUT ROOM SWITCH (ROOM FOUR EXTEND)	HWH WIRING (ROOM FOUR EXTEND)	
HHH 16 YEL	SLIDEOUT ROOM SWITCH (ROOM FOUR RETRACT)	SLIDEOUT ROOM SWITCH (ROOM FOUR RETRACT)	
HHJ 14 YEL	110V WATER HEATER TRIGGER SWITCH	WATER HEATER RELAY	
HHK 14 YEL	DRIVER'S POWER SUNVISOR SWITCH	DRIVER'S POWER SUNVISOR	
HHL 14 YEL	DRIVER'S POWER SUNVISOR SWITCH	DRIVER'S POWER SUNVISOR	
HHM 14 YEL	PASS POWER SUNVISOR SWITCH	PASS POWER SUNVISOR	

CODE/COLOR	FROM:	WIRE IDENTIFICATION	CHART TO:
HHN 14 YEL	PASS POWER SUNVISOR SWITCH		PASS POWER SUNVISOR
HHP 14 YEL	HOT WATER HEAT CONTROL BOARD (F1)		ZONE 1 FAN SPEED SWITCH
HHR 14 YEL	ZONE 1 FAN SPEED SWITCH		ZONE 1 HEATER FAN
HHS 16 YEL	HOT WATER HEAT CONTROL BOARD (TC)		ZONE 2 & 3 THERMOSTAT
HHT 16 YEL	HOT WATER HEAT CONTROL BOARD (T2)		ZONE 2 THERMOSTAT
HHU 14 YEL	HOT WATER HEAT CONTROL BOARD (F2)		ZONE 2 FAN SPEED SWITCH
HHV 14 YEL	ZONE 2 FAN SPEED SWITCH		ZONE 2 HEATER FAN
HHW 16 YEL	HOT WATER HEAT CONTROL BOARD (T3)		ZONE 3 THERMOSTAT
HHX 14 YEL	HOT WATER HEAT CONTROL BOARD (F3)		ZONE 3 HEATER FAN
HHY 16 WHT	AWNING CONTROL BOX		WIND SENSOR (NEGATIVE)
HHZ 16 YEL	AWNING CONTROL BOX		WIND SENSOR (POSITIVE)
JJA 16 YEL	AWNING CONTROL BOX		WIND SENSOR TEMPERATURE OUTPUT
JJB 16 YEL	AWNING CONTROL BOX		WIND SENSOR SPEED OUTPUT
JJC 14 YEL	ENGINE HEATER CIRCULATING PUMP SWITCH		HOT WATER HEAT CONTROL PANEL (BLU/BLK WIRE)
JJD 10 YEL	OVERCURRENT PROTECTION (25 FUSE TYPICAL)		HOT WATER HEAT CONTROL BOARD
JJE 10 WHT	HOT WATER HEAT CONTROL BOARD		GROUND
JJF 14 YEL	SATELLITE POWER SWITCH		SATELLITE-AUTO SEEK
JJG 12 YEL	OVERCURRENT PROTECTION (20 AMP BREAKER TYPICAL)		SLIDEOUT ROOM CONTROL SWITCH (RAM #3)
JJH 12 WHT	SLIDEOUT ROOM CONTROL SWITCH (RAM #3)		GROUND

CODE/COLOR	FROM:	WIRE IDENTIFICATION CHART TO:
JJJ 12 YEL	SLIDEOUT ROOM CONTROL SWITCH (RAM #3)	SLIDEOUT DRIVE MOTOR LEAD #1
JJK 12 YEL	SLIDEOUT ROOM CONTROL SWITCH (RAM #3)	SLIDEOUT DRIVE MOTOR LEAD #2
JJL 12 YEL	OVERCURRENT PROTECTION (20 AMP BREAKER TYPICAL)	SLIDEOUT ROOM CONTROL SWITCH (RAM #2)
JJM 16 YEL	HWH WIRING (SWITCHED BATTERY POWER)	SLIDEOUT ROOM SWITCH #2 (SWITCHED EXTEND/RETRACT PWR)
JJN 16 YEL	HWH WIRING (SWITCHED BATTERY POWER)	SLIDEOUT ROOM SWITCH #3 (SWITCHED EXTEND/RETRACT PWR)
JJP 16 YEL	HWH WIRING (SWITCHED BATTERY POWER)	SLIDEOUT ROOM SWITCH #4 (SWITCHED EXTEND/RETRACT PWR)
JJR 16 YEL	REMOTE SWITCH (EXTEND)	PATIO AWNING CONTROL MODULE (RELAY POSITION 87A,EXTEND)
JJS 12 YEL	REMOTE SWITCH	DOOR AWNING CONTROL RELAY (RELAY POSITION 87A,EXTEND)
JJT 14 YEL	OVERCURRENT PROTECTION (15A FUSE/BREAKER TYPICAL)	COACH 12V RECEPTACLES (REF JJU)
JJU 14 WHT	COACH 12V RECEPTACLES (REF JJT)	GROUND
JJV 14 YEL	MONITOR PANEL LAMP SWITCH	MONITOR PANEL LAMP
JJW 14 YEL	RUN ONLY POWER BREAKER	RUN ONLY POWER RELAY
JJX 14 YEL	RUN ONLY POWER RELAY	GENERAL PURPOSE (RUN ONLY FEED)
JJY 14 YEL	RUN/ACC POWER #1 BREAKER	RUN/ACC POWER #1 RELAY
JJZ 14 YEL	RUN/ACC POWER #1 RELAY	GENERAL PURPOSE (RUN/ACC FEED #1)
KKA 14 YEL	RUN/ACC POWER #2 BREAKER	RUN/ACC POWER #2 RELAY
KKB 14 YEL	RUN/ACC POWER #2 RELAY	GENERAL PURPOSE (RUN/ACC FEED #2)
KKC 12 YEL	POWER SEAT RELAY	POWER SEAT (HEATER)
KKD 16 YEL	CONFIRMATION EMERGENCY SHUT'OFF SWITCH (IN COACH)	EMERGENCY SHUT'OFF SWITCH (ON REMOTE FILL BRACKET)

CODE/COLOR	FROM:	WIRE IDENTIFICATION CHART TO:
KKE 16 YEL	EMERGENCY SHUT'OFF SWITCH (ON REMOTE FILL BRACKET)	EMERGENCY SHUT'OFF SOLENOID (ON LP TANK)
KKF 6 BLK	BATTERY DISCONNECT RELAY	COACH BUSS BAR
KKG 8 BLK	BATTERY MODE SOLENOID	CHASSIS BUSS BAR
KKH 14 YEL	EXTERIOR SERVICE LAMP SWITCH #1	EXTERIOR SERVICE LAMP SWITCH #2
KKJ 14 YEL	EXTERIOR SERVICE LAMP SWITCH #1	EXTERIOR SERVICE LAMP SWITCH #2
KKK 16 YEL	HWH WIRING (SWITCHED BATTERY POWER)	SLIDEOUT ROOM #2 SWITCH (POSITIVE)
KKL 16 YEL	HWH WIRING (SWITCHED BATTERY POWER)	SLIDEOUT ROOM #3 SWITCH (POSITIVE)
KKM 16 YEL	HWH WIRING (SWITCHED BATTERY POWER)	SLIDEOUT ROOM #4 SWITCH (POSITIVE)
KKN 14 YEL	KEYLESS ENTRY PORCH LIGHT OUTPUT	PORCH/STEP/MAP LAMP
KKP 14 YEL	LOUNGE CEILING ROPE LAMP SWITCH	LOUNGE CEILING ROPE LAMP
KKR 14 YEL	BEDROOM CEILING ROPE LAMP SWITCH	BEDROOM CEILING ROPE LAMP
KKS 14 YEL	BEDROOM VALANCE LAMP SWITCH	BEDROOM VALANCE LAMP
KKT 14 YEL	BEDROOM "MOOD" LAMP SWITCH	BEDROOM "MOOD" LAMP
KKU 16 YEL	REAR TV SPEAKER OUTPUT (RIGHT POSITIVE)	RIGHT SPEAKER (POSITIVE)
KKV 16 WHT	REAR TV SPEAKER OUTPUT (RIGHT NEGATIVE)	RIGHT SPEAKER (NEGATIVE)
KKW 16 YEL	REAR TV SPEAKER OUTPUT (LEFT POSITIVE)	LEFT SPEAKER (POSITIVE)
KKX 16 WHT	REAR TV SPEAKER OUTPUT (LEFT NEGATIVE)	LEFT SPEAKER (NEGATIVE)
KKY 14 YEL	OVERCURRENT PROTECTION (15A FUSE/BREAKER TYPICAL)	COACH LIGHTING,ETC CIRCUIT #8 (REF KKZ)
KKZ 14 WHT	COACH LIGHTING (REF KKY)	GROUND

CODE/COLOR	FROM:	WIRE IDENTIFICATION	CHART TO:
LLA 14 YEL	OVERCURRENT PROTECTION (15A FUSE/BREAKER TYPICAL)		COACH LIGHTING,ETC CIRCUIT #9 (REF LLB)
LLB 14 WHT	COACH LIGHTING (REF LLA)		GROUND
LLC 14 YEL	SEAT HEATER BREAKER (15 AMP BREAKER TYPICAL)		SEAT HEATER RELAY POSITION 30
000	GURRENT DRAW LIST	NOTE:	LISTS OF CURRENT DRAWS FOR STD TRADE NO. BULBS ARE AVAILABLE
001	12 VOLT COACH LIGHTING SEE LINE 500 FOR 120 VOLT		SEE LINE 300 FOR 12 VOLT AUTO SEE LINE 700 FOR 12V FANS,ETC
002	LAMP(CEILING,COMPT,ETC) 1.44AMPS(#1141 BULB)		PROGRESSIVE DYNAMICS 771 098024-01-CHT
003	LAMP(CEILING,ETC) 2.88AMPS(2 #1141 BULBS)		PROGRESSIVE DYNAMICS 773 098024-03-CHT
004	LAMP(MAKEUP) 3.06AMPS(3 #20-99 BULBS)		PROGRESSIVE DYNAMICS 200-621 110235-01-CHT
005	LAMP(MAKEUP) 4.08AMPS(4 #20-99 BULBS)		PROGRESSIVE DYNAMICS 200-622 110235-02-CHT
006	LAMP(DOME,COMPT,ETC) 0.52AMPS(#1414 BULB)		JENSEN 1236 086280-01-000
007	LAMP(WARDROBE) 0.97AMPS(#561 BULB)		PROGRESSIVE DYNAMICS 210-111 087694-01,02-000
008	LAMP(OVER DINETTE) 1.00/1.40AMPS(#912/921 BULB)		GUSTAFSON 548PB-3L CHANDELIER 093575-08-CHT
009	LAMP(WALL) 3.60AMPS(2 #1076 BULBS)		GUSTAFSON 2-BULB W/SHADE 087140-01 THRU 07,10-CHT
010	LAMP(WALL) 1.00/1.40AMPS(#912/921 BULB)		GUSTAFSON SCONCE 087140-08-CHT
011	LAMP(WALL) 1.00/1.40AMPS(#912/921 BULB)		GUSTAFSON SWIVEL 087140-11,12-CHT
012	LAMP(DINETTE OVHD) 2.88AMPS(2 #1141 BULBS)		GUSTAFSON 514F RECTANGULAR 093575-06-CHT
013	LAMP(OVHD,CEILING) 0.94AMPS(#1003 BULB)		INTERTEK Y-605-20 083167-04-CHT
014	LAMP(READING) 15CP BULB		A.W.ASPLUND 81-905 104173-01-CHT
015	LAMP(READING) 1.44AMPS(#1141 BULB)		R.T.SALES 787 (CANADIAN) 104172-01-CHT

CODE/COLOR	FROM:	WIRE IDENTIFICATION	CHART TO:
016	RANGE HOOD LAMP 1.00AMP(#912 BULB)		
017	LAMP(CEILING FLUORESCENT) 2.34AMPS(2 #F15T8-CW)		THINLITE 736 091936-01-CHT
018	LAMP(OVHD FLUORESCENT) 1.25AMPS(2 #F8T5-CW)		THINLITE 732 091936-02-CHT
019	LAMP(PORCH,ETC) 0.94/1.04AMPS(#1003/93 BULB)		BARGMAN 30-78-5XX 097917-01-CHT
020	LAMP(FLUORESCENT) 0.8AMPS		GUEST 83GC-35-B 111217-01-CHT
021	LAMP(WALL) 3.60AMPS(2 #1076 BULBS)		GUSTAFSON 53-507XB7YZ 119258-01-CHT
022	LAMP(DINETTE OVHD) 3.60AMPS(2 #1076 BULBS)		GUSTAFSON 56-550XZ 093575-09-CHT
023	LAMP(COURTESY) .1 AMPS		INTERTEK Y-191-02 061424-01-000
024	LAMP(DINETTE OVHD) 3-BULB		GUSTAFSON 55-548XZ 093575-10-CHT
025	LAMP-HALOGEN,ROUND WITH 10 WATT BULB (.83 AMP)		GUSTAFSON 99-9112YZ 123775-01-CHT
026	LAMP-HALOGEN,COLLAR BRASS		GUSTAFSON 99-31030G0 123775-02-CHT
027	LAMP (MAKEUP W/MIRROR) 4 BULB (4.32 AMP)		GUSTAFSON 58-524XZ 123774-01-CHT
028	BULB (MAKEUP, WHITE) 12 VOLT 13 WATT 1.08 AMP		GUSTAFSON 71-9019F 123918-01-000
029	LAMP-READING,SWIVEL 12 VOLT W/SWITCH BRASS		GUSTAFSON 99-7481XY 123916-01-CHT
030	BULB (READING) 12 VOLT 15 WATT 1.25 AMP		GUSTAFSON 71-1383 123917-01-000
031	LAMP-FLUORESCENT 12 V .7 AMP(F8T5/CW)		THINLITE 141 UL/CSA 113371-01-CHT
032	LAMP-FLUORESCENT 12 V 1.25 AMP (F15T8/CW)		THINLITE 143 UL/CSA 113371-02-CHT
033	LAMP-FLUORESCENT 12V 2.5 AMP (F30T8/CW)		THINLITE 147 UL/CSA 113371-03-CHT
034	LAMP (COURTESY,ROUND) BULB, PHILIPS 12842, .1 AMP		ITC MARINE 81395-B 108354-01-CHT

CODE/COLOR	FROM:	WIRE IDENTIFICATION	CHART TO:
035	LAMP-READING W/SWITCH 12V,20 WATT BULB, 1.7 AMP	MODEL PY-523 132427-01-CHT	
036	DETECTOR-LP GAS .04 AMPS	MODEL 7770.274 103613-03-000	
037	X	X	
X	X	X	
038	X	X	
X	X	X	
039	X	X	
X	X	X	
040	X	X	
X	X	X	
16 YEL	AUX HEAT, A/C UNIT	THERMOSTAT	
300	12 VOLT AUTOMOTIVE SEE 500 FOR 120 VOLT	SEE 000 FOR 12V COACH LIGHTING SEE 700 FOR 12V FANS,ETC	
301	TYPICAL TAILLAMP CURRENT DRAW: 1156,1157,3156, OR 3157 BULBS	STOP=2.10AMPS,BACKUP=2.10AMPS, MARKER=0.59AMPS,TURN=2.10AMPS	
302	TYPICAL CLEARANCE/SIDEMARKER: 194 OR 1895 BULB	0.27AMPS FRT TURN: 2.10AMPS(#1156 BULB)	
303	DOCKING LAMP 2.10AMPS(#1156 BULB)	TRIPLEX 147W 106688-04-000	
304	DOCKING LAMP 2.73AMPS(#4411 SEALED BEAM)	K-D LAMP 895-2353 105901-01-000	
305	HEADLAMP(LOW/HIGH BEAM, RT<) 3.13/4.69AMP(#4652SEALED BEAM)	GMI6508079,16508080,5973929 049185,049186-01-000	
306	HEADLAMP(HIGH BEAM) 3.91AMPS(#4651 SEALED BEAM)	GMI6508077,16508078,5966079 049187,049188-01-000	
307	HEADLAMP(LOW/HIGH BEAM, RT<) 4.30/5.08AMP(#6052SEALED BEAM)	GM 5968097 070907-01-000	
308	FOG LAMP 4.30AMPS	BOSCH 9 307 230 020 088747-01-000	
309	FOG LAMP 3.91AMPS(#9420 SEALED BEAM)	PER LUX 550-SERIES 088747-03-000	
310	INSTRUMENT PANEL LAMP 0.12AMPS(#74 BULB)	103603-01-000 BULB	
311	LICENSE PLATE LAMP 0.35AMPS(#168 BULB)	BARGMAN 30-60-001,30-60-102 066432-01,02-000	

CODE/COLOR	FROM:	WIRE IDENTIFICATION	CHART TO:
312	VACUUM PUMP 0.65AMPS,13.5VOLTS		EVANS RV212471 114802-01-000
313	X		X
314	X		X
315	X		X
316	X		X
317	X		X
318	X		X
319	X		X
320	X		X
500	120 VOLT COMPONENTS SEE 300 FOR 12 VOLT AUTO		SEE 000 FOR 12V COACH LIGHTING SEE 700 FOR 12V FANS,ETC
501	COFFEE MAKER(NOT CARAFE STYLE) 8.3AMPS,1000WATTS(NAME PLATE)		BLACK&DECKER SDCID (SDC-2A?) 092306-01-000&103799-01-CHT
502	VCR 0.15AMPS,17WATTS(NAME PLATE)		MAGNAVOX VR9210,VR9320 098446-06,07-000
503	MICROWAVE 10.2AMPS,1225WATTS(NAME PLATE)		MAGIC CHEF MCD-DM15K-7B 115303-01-000(95,96D,F,C)
504	MICROWAVE-CONVECTION 12.8AMPS (NAME PLATE)		PANASONIC NN-8501V 102479-01-000(91-94F,95M,Q)
505	MICROWAVE 10.0AMPS,1200WATTS(NAMEPLATE)		MAGIC CHEF M16-10PB 091269-03-000
506 SEE 704	REFRIGERATOR(3-WAY) 1.4AMPS @120V, 11.7AMPS @12V		NORCOLD 113737-01-CHT(94,95H)
507 SEE 706	REFRIGERATOR 2.7AMPS,300WATTS(NAME PLATE)		NORCOLD 6162 104138-04,05-CHT(92-95C,F)
508 SEE 707	REFRIGERATOR 2.7AMPS,300WATTS(NAME PLATE)		NORCOLD 6182 104137-06,07,08,09-CHT(93-95G)
509 SEE 708	REFRIGERATOR 2.7AMPS,300WATTS(NAME PLATE)		NORCOLD 682 104137-02,03,04,05-CHT(92-95M)

CODE/COLOR	FROM:	WIRE IDENTIFICATION CHART TO:
510 SEE 709	REFRIGERATOR 1.7AMPS,200WATTS(NAME PLATE)	NORCOLD 6052 102621-04-CHT(93-95D)
511	TELEVISION-13" 1.00AMP(NAME PLATE)	MAGNAVOX 13PRC10 098447-11-000(95,95F,Q)
512	TELEVISION-13"CSA 1.00AMP(NAME PLATE)	MAGNAVOX XR1333 098447-10-000(93M)
513 SEE 710	TELEVISION-9" AC/DC 0.46AMPS,55WATTS(NAME PLATE)	MAGNAVOX RD0945 092310-02,03-000
514	TELEVISION-19" CSA 1.2AMPS(NAME PLATE)	MAGNAVOX XR1933 108096-06-000(94,95M,Q)
515	TELEVISION-19" 0.71AMPS,85WATTS(NAME PLATE)	AUDIOVOX ATV-1975 113684-01-000(94,95C,F)
516	CONVERTER-ELECTRONIC,40AMP 5.5AMPS,660WATTS(NAME PLATE)	MAGNETEK 7240 109171-01-000
517	CONVERTER-ELECTRONIC,55AMP 7.75AMPS,930WATTS(NAME PLATE)	MAGNETEK 7255 108171-02-000
518	WATER HEATER 12.5AMPS,1500WATTS(NAME PLATE)	ATWOOD EHM4-SM 113122-01-000
519	WATER HEATER(EUROPEAN,220VOLT)	ATWOOD EHM4-220 113122-02-000
520	CONVERTER-LINEAR,20AMP 3.5AMPS(NAME PLATE)	MAGNETEK 3220CPX 092615-02-000 VW B-VAN
521	BLENDER(BUILT IN) 5.4AMPS,650WATTS(NAME PLATE)	NUTONE 251 023111-01-000 (OLD M40)
522	HAIR DRYER(WALL MOUNT) 10.0AMPS,1200WATTS(NAMEPLATE)	OSTER 317-06 096696-01-CHT (OLD M40)
523	VACUUM CLEANER(BUILT IN) 7.0AMPS(NAMEPLATE)	HP 19-1 108186-01-000
524	CONVERTER-LINEAR,45 AMP 7.8AMPS(NAME PLATE)	MAGNETEK MODEL 6345 (BW 6345) 083208-02-000
525	CONVERTER-ELECTRONIC,55 AMP 8.13AMPS,975WATTS(NAME PLATE)	MAGNETEK 7455BT 123058-01-000 13.6 VOLT
526	CONVERTER-ELECTRONIC 45AMP 6.46AMPS,775WATTS(NAME PLATE)	MAGNETEK 7445 123058-02-000 13.6 VOLT
527	TELEVISION-19' 1/8JACK UL/CSA AMPS, WATTS(NAME PLATE)	RCA F19207M 124075-03-000
528	DISHWASHER 10. AMP	X 107752-01

CODE/COLOR	FROM:	WIRE IDENTIFICATION CHART TO:
529	WASHER/DRYER CIRCUIT BREAKER 20A US,15A CSA	BENDIX 12.8 AMP MFG RATING 107753-03-CHT
530	X	X
531	X X	X X
532	X	X
533	X	X
534	X	X
535	X	X
700	12 VOLT COACH EXCEPT LIGHTING SEE 300 FOR 12 VOLT AUTO	SEE 000 FOR 12V COACH LIGHTING SEE 500 FOR 120 VOLT
701	VENT FAN(3-SPEED CEILING) 1.86,2.29,3.00AMPS(LO,MED,HI)	FANTASTIC 088265-01 THRU 11-CHT
702	VENT FAN 1.30AMPS	JENSEN 110051-02 THRU 10-CHT
703	VENT FAN 1.20AMPS	CAPCO 090394-01-XXX
704 SEE 506	REFRIGERATOR(3-WAY) 11.7AMPS @12V, 1.4AMPS @120V	NORCOLD 113737-01-CHT 94,95 RIALTA
705	WATER PUMP 4.0AMPS	SHURFLO 2088-403-144 098607-01-000
706 SEE 507	REFRIGERATOR 1.8AMPS(NAME PLATE)	NORCOLD 6162 104138-04,05-CHT
707 SEE 508	REFRIGERATOR 1.8AMPS(NAME PLATE)	NORCOLD 6182 104137-06,07,08,09-CHT
708 SEE 509	REFRIGERATOR 1.8AMPS(NAME PLATE)	NORCOLD 682 104137-02,03,04,05-CHT
709 SEE 510	REFRIGERATOR 0.5AMPS(NAME PLATE)	NORCOLD 6052 102621-04-CHT
710 SEE 513	TELEVISION-9" AC/DC 3.0AMPS,36WATTS(NAME PLATE)	MAGNAVOX RD0945 092310-02,03-000
711	FURNACE-20000(19000?)BTU 2.8AMPS(NAME PLATE)	SUBURBAN NT-20S 075697-01-000

WIRE IDENTIFICATION CHART		
CODE/COLOR	FROM:	TO:
712	WATER HEATER 61.00AMP(NAME PLATE)	ATWOOD G6A-7E 051391-03-000
713	WATER PUMP 2.1AMPS(NAME PLATE)	SHURFLO 100-000-21 111225-01-000 VW B-VAN
714	FURNACE-12000BTU 2.8AMPS(NAME PLATE)	SUBURBAN NT-12S 075697-05-000 VW B-VAN
715	FURNACE-17000BTU	X 101990-03-000(95D)
716	TELEVISION-13" AC/DC AMPS,77WATTS(NAME PLATE)	RCA E13335GY 124074-02-000
717	TELEVISION-13' AC/DC 4.0AMPS, WATTS(NAME PLATE)	AUDIOVOX 086231-08-000
718	FURNACE 25000 BTU 6.5 AMPS (NAME PLATE)	SUBURBAN SF-25 2289 098668-19-000
719	FURNACE 30000 BTU 6.5 AMPS (NAME PLATE)	SUBURBAN SF-30 2290 098668-20-000
720	FURNACE 35000 BTU 9.0 AMPS (NAME PLATE)	SUBURBAN SF-35 2291 098668-21-000
721	FURNACE 40000 BTU 11.5 AMPS (NAME PLATE)	SUBURBAN SF-42 2292 098668-22-000
722	PLAYER-CASSETTE,VIDIO AUDIVX 12V,12 WATT	ASA AVP-7000 094487-04-000