



DANGER

Danger of electrical shock, burns or death. Always remove all power sources before attempting any repair, service or diagnostic work. Power can be present from shore power, generator, inverter or battery. All power sources must be disabled and secured before performing any service.



CAUTION

If you lack the skills, tools or equipment to perform diagnostic or repair work leave such work to an authorized Winnebago Industries dealer or other qualified shop.

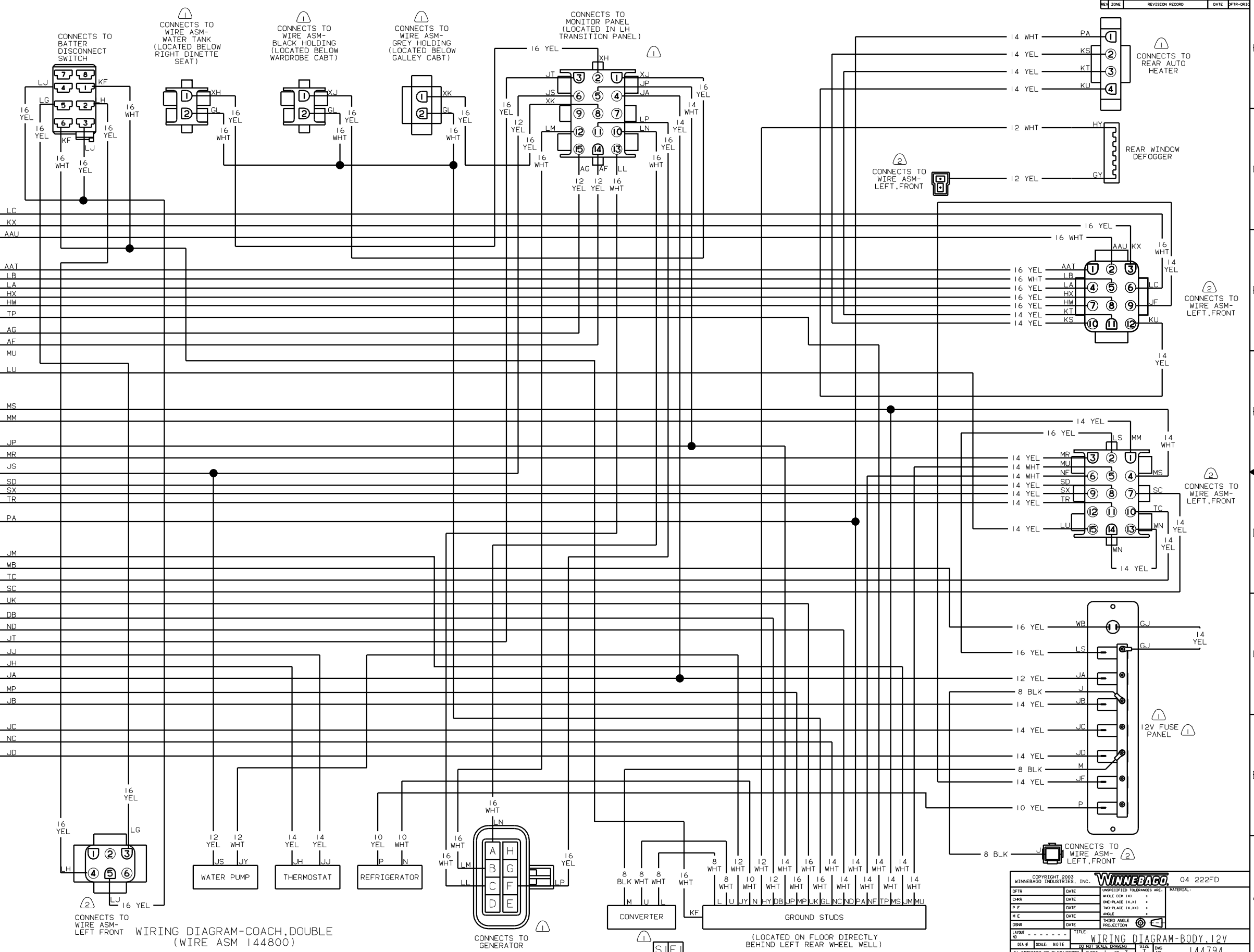

WIRING DIAGRAM-COACH, DOUBLE
 (WIRE ASM 144800)

WIRING DIAGRAM-BODY, 12V
 (LOCATED ON FLOOR DIRECTLY BEHIND LEFT REAR WHEEL WELL)

COPYRIGHT 2003 WINNEBAGO INDUSTRIES, INC. WINNEBAGO 04 222FD	
DATE	UNSPECIFIED TOLERANCES ARE:
DATE	WHOLE DIM (X.X)
DATE	ONE-PLACE (X.XX)
DATE	TWO-PLACE (X.XXX)
DATE	ANGLE
DATE	THIRD ANGLE PROJECTION
DATE	TITLE
LAYOUT NO. 144794	
DIA #	SCALE: NOTE
DO NOT SCALE DRAWING	SIZE: 11x17
ALL DIMENSIONS ARE IN MILLIMETERS	SHEET 1 OF 3
REF: 141391 A	DATE: 08/11/03

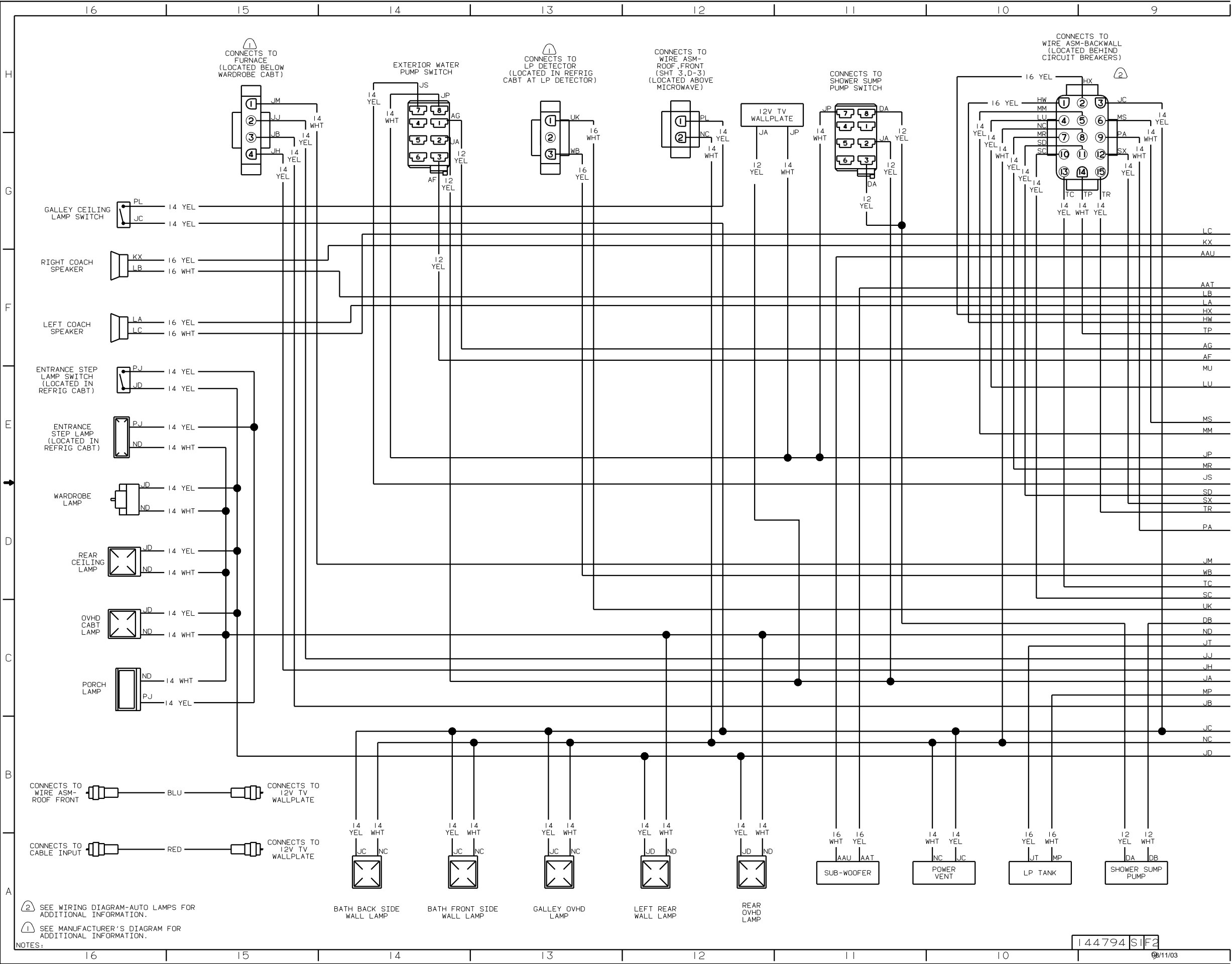

① CONNECTS TO FURNACE (LOCATED BELOW WARDROBE CABT)

① CONNECTS TO LP DETECTOR (LOCATED IN REFRIG CABT AT LP DETECTOR)

CONNECTS TO WIRE ASM-ROOF FRONT (SHT 3, D-3) (LOCATED ABOVE MICROWAVE)

CONNECTS TO SHOWER SUMP PUMP SWITCH

CONNECTS TO WIRE ASM-BACKWALL (LOCATED BEHIND CIRCUIT BREAKERS)

GALLEY CEILING LAMP SWITCH
PL 14 YEL
JC 14 YEL

RIGHT COACH SPEAKER
KX 16 YEL
LB 16 WHT

LEFT COACH SPEAKER
LA 16 YEL
LC 16 WHT

ENTRANCE STEP LAMP SWITCH (LOCATED IN REFRIG CABT)
PJ 14 YEL
JD 14 YEL

ENTRANCE STEP LAMP (LOCATED IN REFRIG CABT)
PJ 14 YEL
ND 14 WHT

WARDROBE LAMP
JD 14 YEL
ND 14 WHT

REAR CEILING LAMP
JD 14 YEL
ND 14 WHT

OVHD CABT LAMP
JD 14 YEL
ND 14 WHT

PORCH LAMP
ND 14 WHT
PJ 14 YEL

CONNECTS TO WIRE ASM-ROOF FRONT (BLU) CONNECTS TO 12V TV WALLPLATE

CONNECTS TO CABLE INPUT (RED) CONNECTS TO 12V TV WALLPLATE

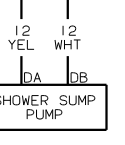
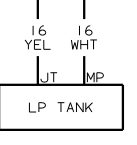
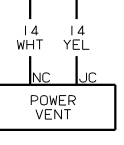
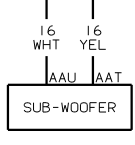
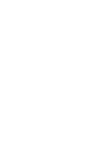
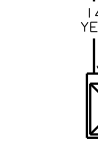
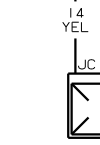
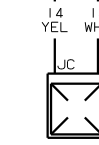
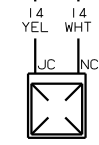

BATH BACK SIDE WALL LAMP

BATH FRONT SIDE WALL LAMP

GALLEY OVHD LAMP

LEFT REAR WALL LAMP

REAR OVHD LAMP

SUB-WOOFER

POWER VENT

LP TANK

SHOWER SUMP PUMP

② SEE WIRING DIAGRAM-AUTO LAMPS FOR ADDITIONAL INFORMATION.
① SEE MANUFACTURER'S DIAGRAM FOR ADDITIONAL INFORMATION.

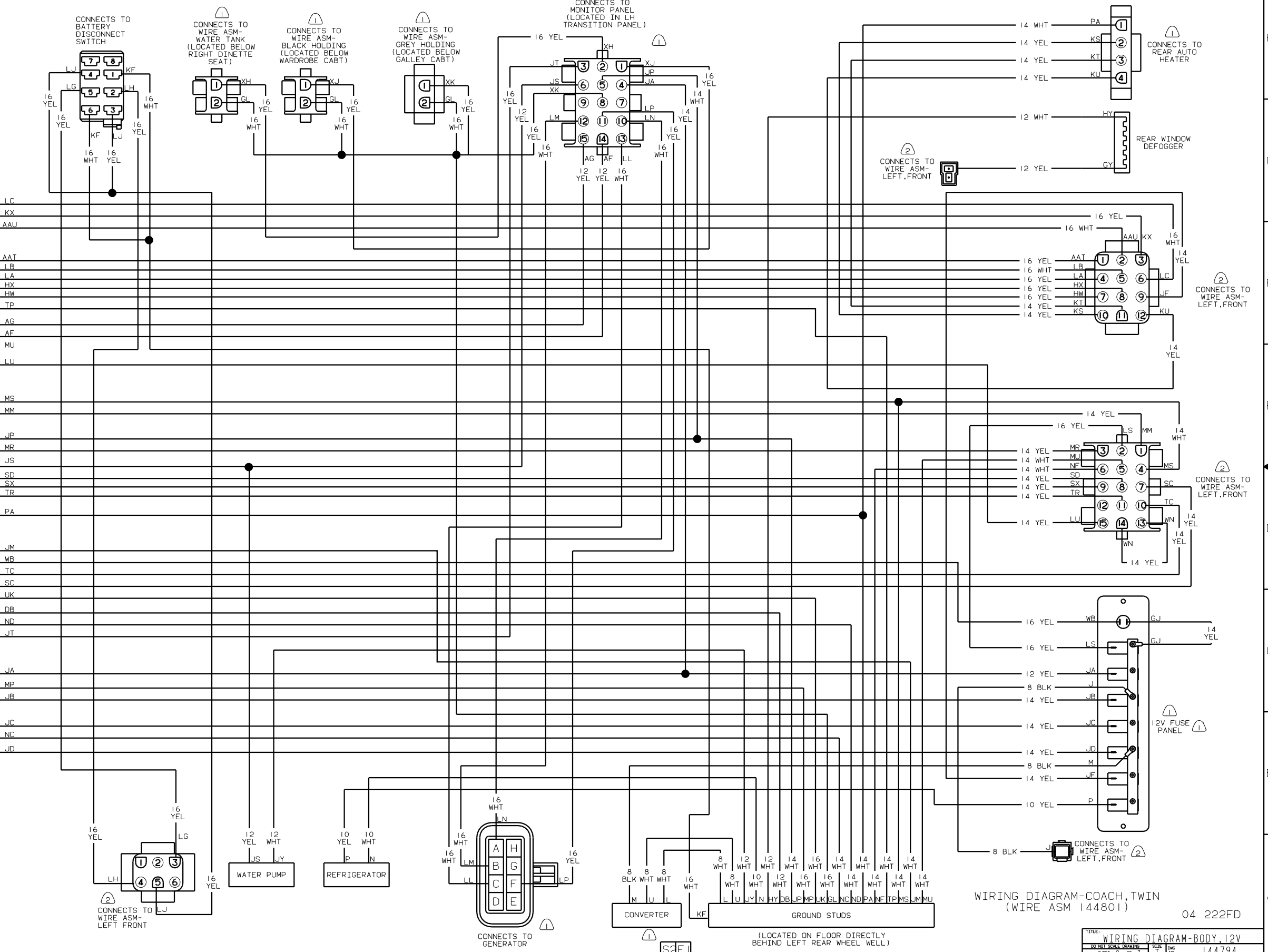

WIRING DIAGRAM-COACH, TWIN (WIRE ASM 144801)

04 222FD

TITLE: WIRING DIAGRAM-BODY, 12V	
DO NOT SCALE DRAWING	SIZE: 144794
SHEET 2 OF 3	DATE: 08/11/03

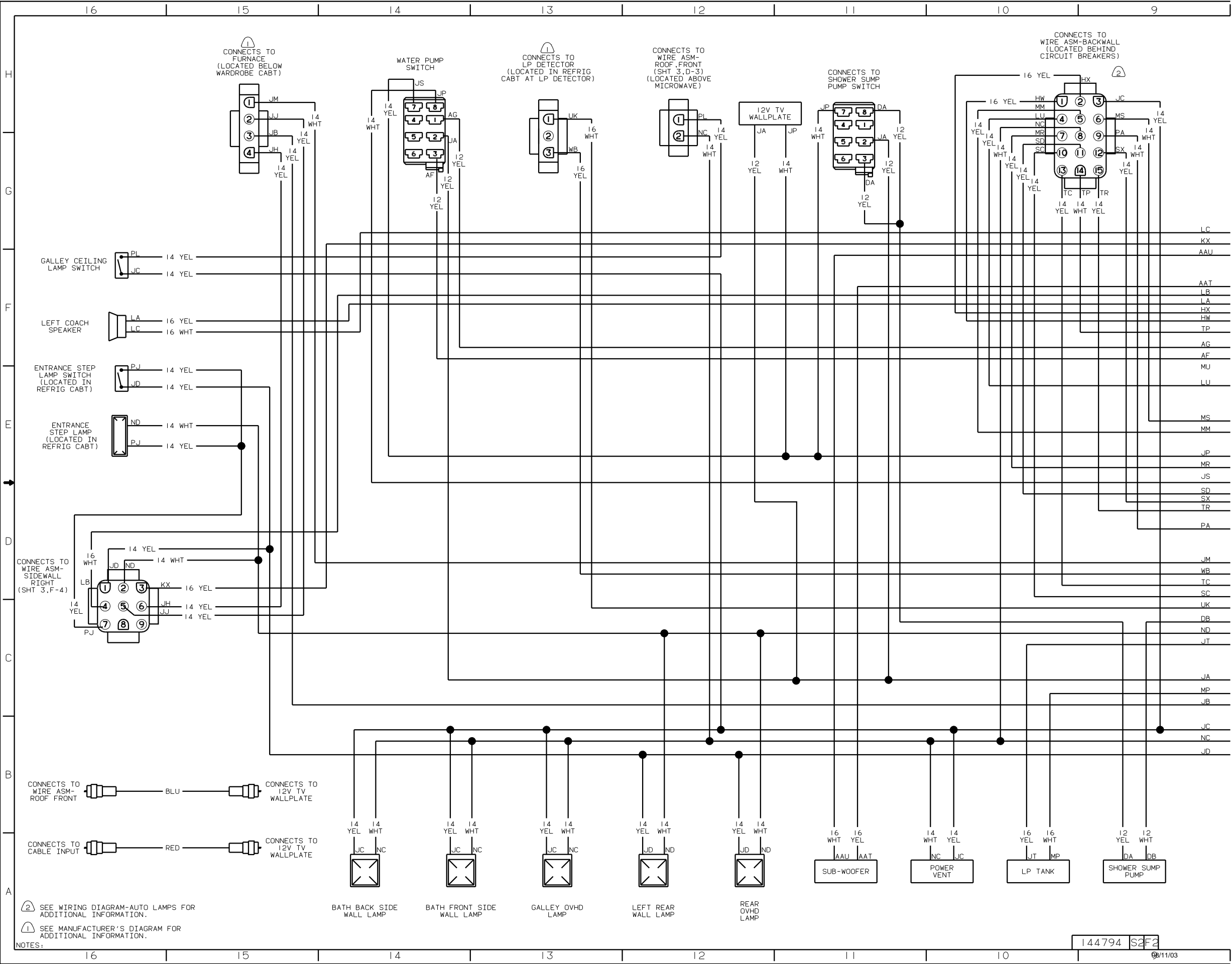

CONNECTS TO FURNACE (LOCATED BELOW WARDROBE CABT)

WATER PUMP SWITCH

CONNECTS TO LP DETECTOR (LOCATED IN REFRIG CABT AT LP DETECTOR)

CONNECTS TO WIRE ASM-ROOF FRONT (SHT 3.D-3) (LOCATED ABOVE MICROWAVE)

CONNECTS TO SHOWER SUMP PUMP SWITCH

CONNECTS TO WIRE ASM-BACKWALL (LOCATED BEHIND CIRCUIT BREAKERS)

GALLEY CEILING LAMP SWITCH

LEFT COACH SPEAKER

ENTRANCE STEP LAMP SWITCH (LOCATED IN REFRIG CABT)

ENTRANCE STEP LAMP (LOCATED IN REFRIG CABT)

CONNECTS TO WIRE ASM-SIDEWALL RIGHT (SHT 3.F-4)

CONNECTS TO WIRE ASM-ROOF FRONT

CONNECTS TO CABLE INPUT

NOTES:
 ② SEE WIRING DIAGRAM-AUTO LAMPS FOR ADDITIONAL INFORMATION.
 ① SEE MANUFACTURER'S DIAGRAM FOR ADDITIONAL INFORMATION.

BATH BACK SIDE WALL LAMP

BATH FRONT SIDE WALL LAMP

GALLEY OVHD LAMP

LEFT REAR WALL LAMP

REAR OVHD LAMP

SUB-WOOFER

POWER VENT

LP TANK

SHOWER SUMP PUMP

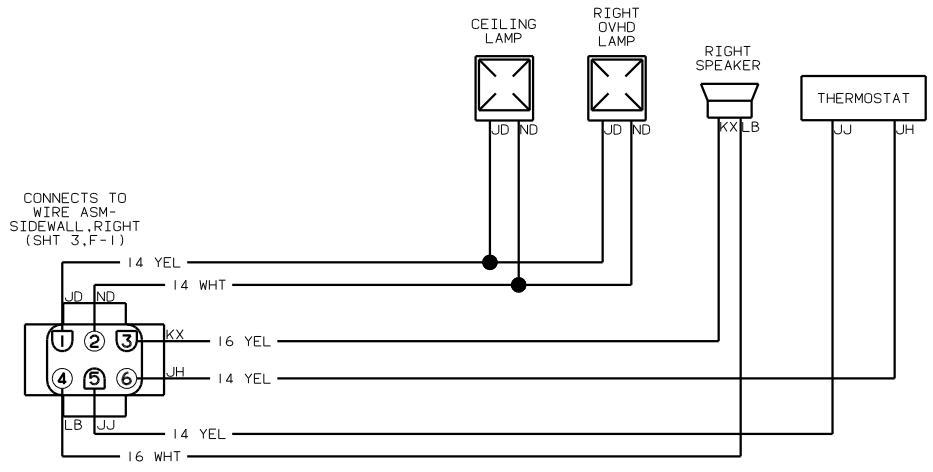

WIRING DIAGRAM-OVHD (WIRE ASM 119701)

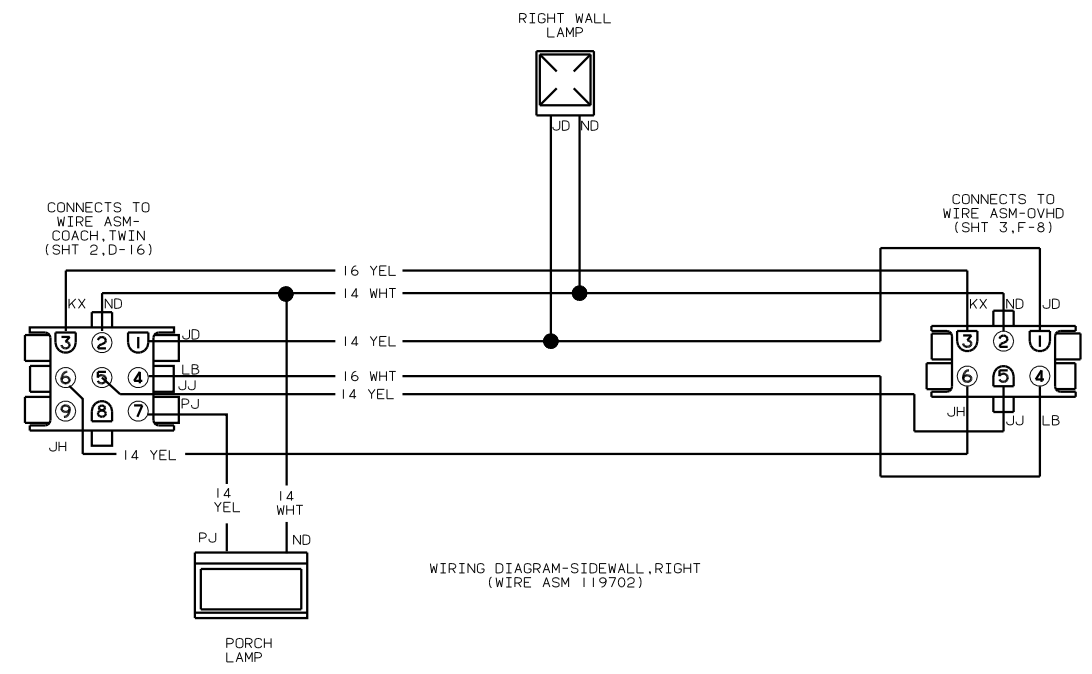

WIRING DIAGRAM-SIDEWALL, RIGHT (WIRE ASM 119702)

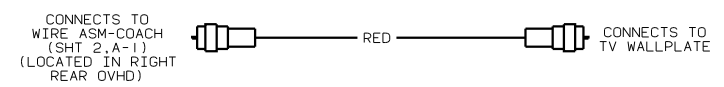
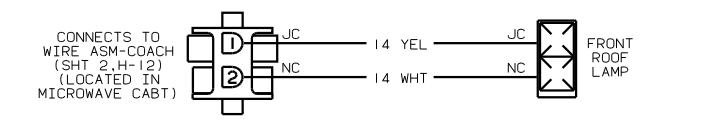

WIRING DIAGRAM-ROOF, FRONT (WIRE ASM 133878)